



ClayTech C3X & C5X Domestic Self Priming Pressure Boosting Pump

811523 / CLA-C3X

811524 / CLA-C5X



1. Quick installation guide

Getting the basics right when you install your pump is the first step to ensuring reliable operation and a good service life

There is additional, more detailed information within the user manual

The pump should be grounded to prevent electrical leakage and supplied via a leakage protection switch with a protection current not exceeding 30mA.

Avoid using extension cords

The pump turns on automatically when the system pressure falls to 1.5 bar

The pump turns off when flow falls below 1 litre per minute

To minimise excessive and unnecessary pump starts fit a 2, 8 or 18 litre pressure tank into the delivery pipe

Protect your pump from the weather

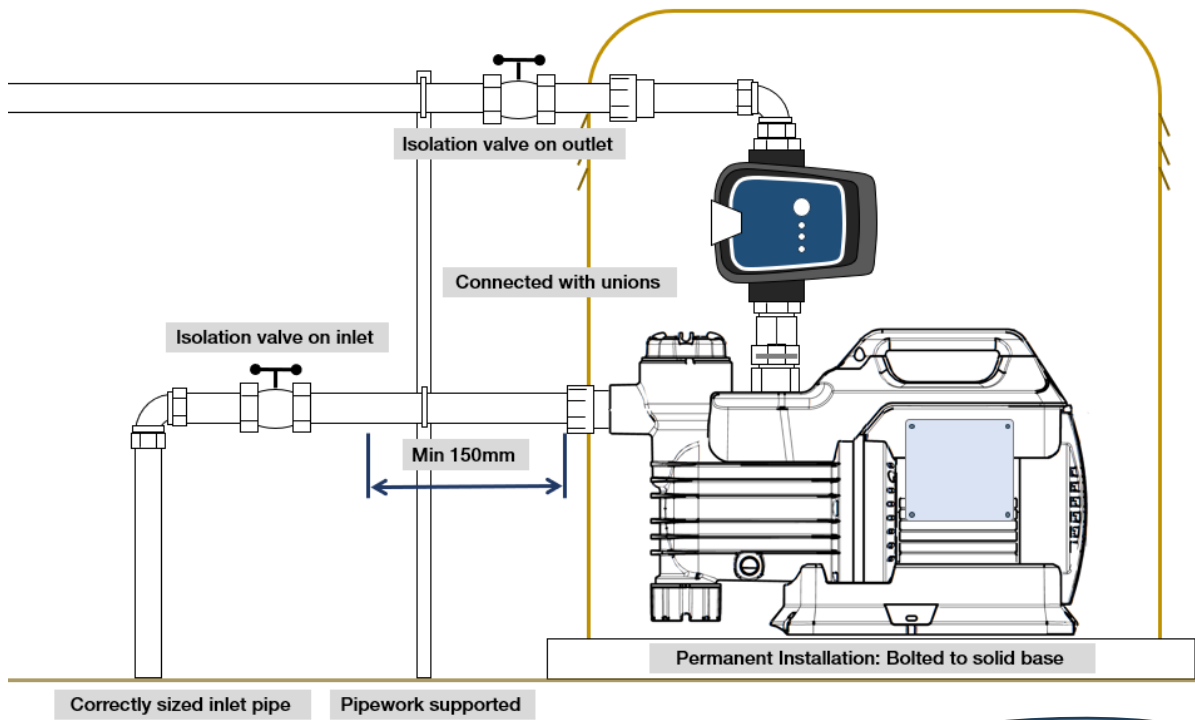

Suction pipe:

- 25 or 32mm inside suction rated pipe
- As short and straight as practical
- Tank fed – fit a non return valve and an inlet isolation valve
- Suction lift – fit a non return type foot valve

Fill the pump with water before running



2. Introduction





Thank you for choosing a **CLAYTECH C Series** Pump.

CLAYTECH C3X and C5X are Self-Priming centrifugal jet pumps with excellent suction capacity, even when air is present in the water. Ideal for water supply and pressure boosting in houses. Suitable for small rural and gardening applications or for general ‘hobby’ activity. With compact sizing and a handy carry handle, ClayTech C3X and C5X are portable so suitable for emergency use such as drawing water from tanks or rivers.

3. Key Features

- Self-priming ‘jet’ type pump
- Inlet strainer with inspection lid
- Portable with large stable foot plate
- Automatic pump ‘Pressure Controller’ with 1.5 bar start pressure
 - Dry run sensing and auto restart function when water supply is available.
 - Complete with pressure gauge and inbuilt non return mechanism.



4. Symbols used in this manual

| | |
|---|--|
|  | Warning - Electrical safety |
|  | Warning – Potential consequences of use outside of intended application(s). Includes environmental condition warnings. |
|  | Mandatory warning |
|  | Warning to disconnect power |
|  | Read carefully |









5 Contents

| | |
|--|--------|
| 1. Quick installation guide | 2 |
| 2. Introduction | 3 |
| 3. Key Features..... | 3 |
| 4. Symbols used in this manual | 3 |
| 5 Contents | 4 |
| 6. Standards and Approvals..... | 4 |
| 7. Warnings | 5 |
| 8. Technical Specifications..... | 7 - 8 |
| 10. Assembly | 7 |
| 11. Installation | 9 - 10 |
| 12. Operation | 10 |
| 13. Maintenance and Cleaning..... | 11 |
| 14. Trouble Shooting..... | 12 |
| 15. Warranties – Terms and Conditions..... | 13 |

6. Standards and Approvals

| | |
|---|---|
|  | <p>The RCM is a symbol that represents compliance with two independent schemes: EESS; and ACMA’s labelling requirements</p> <p>For electrical safety, in-scope electrical equipment must not be sold unless the item is marked with the RCM in compliance with AS/NZS 4417.1 & 2 and the EESS.</p> |
|  | <p>Pumps that carry the AS/NZ4020 Drinking Water Approval demonstrate compliance with requirements of Australia & New Zealand Standards of products that come into contact with water intended for human consumption. This approval also ensures that the water coming from the pump will not be contaminated by toxic materials or metals. It also means the water will not support the growth of micro-organisms and will not cause a change in taste or appearance.</p> |
|  | <p>CE marking is a certification mark that indicates conformity with health, safety and environment. The CE marketing represents a manufacturer’s declaration that products comply with the EU’s New Approach Directives. These directives not only apply to products within the EU but also for products that are manufactured in or designed to be sold in the EEA.</p> |

7. Warnings

| | |
|---|--|
|  | <p>Read the manual carefully before starting and retain for future reference.</p> |
|  | <p>Prior to starting installation or maintenance, the controller must be disconnected from the power supply and pressure relieved from the system including controller, pump and associated pipework.</p> |
|  | <p>Any changes or modification to the wiring must be carried out by suitably qualified personnel.</p> |
|  | <p>A qualified electrician should correctly size and install circuit breakers to protect the power supply. The fitment of additional surge protection is recommended.</p> <p>Australian Electrical Regulations 2020 state this MUST include an IM = 30mA safety switch</p> |
|  | <p>This appliance is not intended for use by persons (including children) with reduced physical, sensory or mental capabilities, or lack of experience and knowledge, unless they have been given supervision or instruction concerning use of the appliance by a person responsible for their safety. Children should be supervised to ensure that they do not play with the appliance.</p> |
|  | <p>The pump must never be carried, lifted or allowed to operate suspended from the power cable; use the handle provided.</p> |
|  | <p>The pump is not designed to support the load from connecting pipework. All pipework must be supported in some other manner.</p> |
|  | <p>Never open the cover while the controller is connected to electrical supply.</p> |
|  | <p>Never connect AC power to the output terminals of the controller as this will cause damage to the controller not covered under warranty.</p> |

8. Technical Specifications

| | | C3X | C5X |
|------------------------|---------------------------------------|-----------------------------|---------------------|
| Electrical data | P1 Rated power (W) | 650W | 850W |
| | P2 Rated power (W) | 375W | 475W |
| | Rated voltage | 220V-240V | |
| | Mains frequency (Hz) | 50Hz | |
| | Rated current | 2.6 A @ 230V | 3.4 A @ 230V |
| | Power cable type | HS-05 | |
| | Capacitor (uF) | 10uf | 20uF |
| Hydraulic data | Max flow (lpm / m3/h) | 55 lpm 3300. l/h | 63 lpm 3780. l/h |
| | Max head (m) | 35m | 43m |
| | Start Pressure (Bar) | Default cut-in 1.5 bar | |
| | Stop Condition | Cut out on no flow <1.2 lpm | |
| | Max suction depth (m/min) | 8m/<3min | |
| Range of use | Length of power cable (m) | 1.5m | |
| | Motor protection level | Class F | |
| | Protection class | IPX4 | |
| | Impellers | Single, Technopolymer | |
| | Filter | Integrated, 1mm particles | |
| | Liquid temperature range (°C) | 3°C to 35°C | |
| | Environmental temperature (°C) | -10°C to 40°C | |
| | Max diameter of particle | 2mm | |
| | Motor | Air cooled, 2 pole | |
| | Outlet | 1" BSP | |
| | Package dimension | 640 x 325 x 193mm | |
| Weight | Gross weight (kg) | 9 kg | |

This pump must never be used to pump salt water, sewage, flammable, corrosive or explosive liquids (e.g. petroleum oil, petrol, and thinners), grease, oils or foodstuffs.

If the pump has been used with substances that tend to form a deposit, or with water containing chlorine, rinse it after use with a strong jet of water to prevent formation of deposits or encrustations which could reduce the performance of the pump.

9. Technical Specifications con't

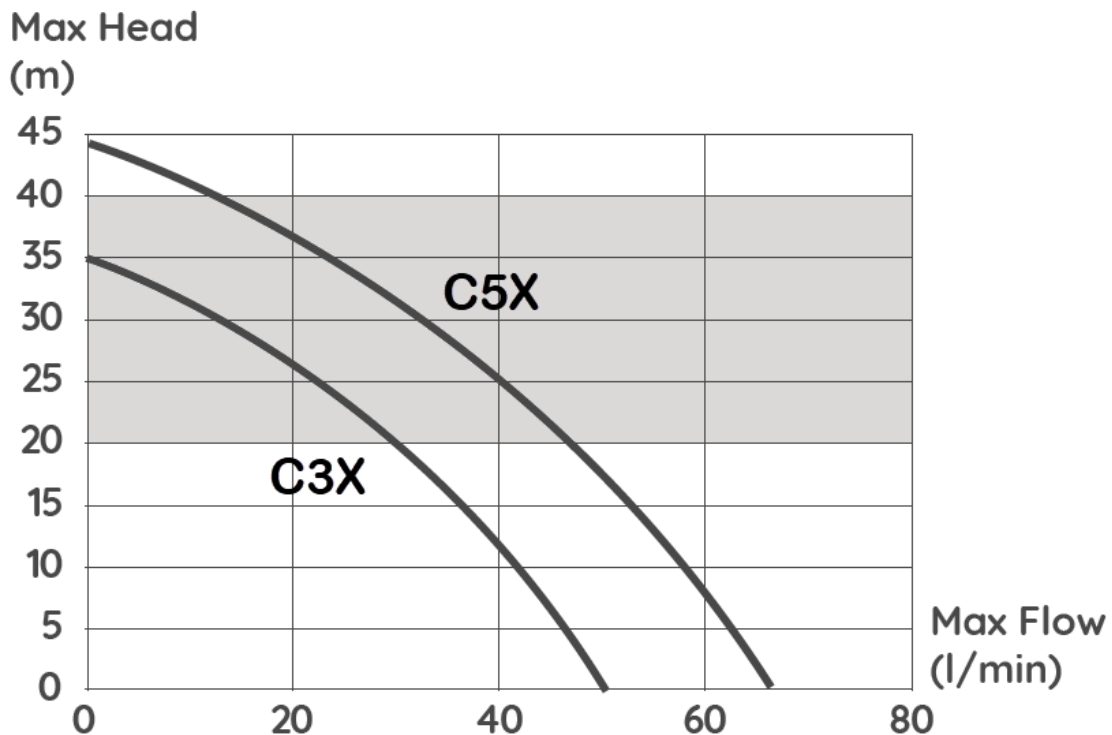

Most domestic applications find 2.0 – 4 bar pressure sufficient.

10. Assembly

CONNECTING THE CONTROLLER TO THE PUMP

The controller and the pump are each pre-fitted with one half of an innovative quick-connect swivel union which allows the controller to be rotated freely to face the desired direction

- Unpack the pump and the controller. Dispose of the packaging carefully
- Remove the stainless C-clip and press the controller union into the pump outlet union socket on the top of the pump (take care not to damage the O-ring). *Wetting the O-ring or using a little silicon grease may aid assembly*
- Carefully refit the stainless C-clip to lock the 2 halves of the swivel union together
- Connect the 3-pin plug from the pump to the socket of the controller.
- Plug the controller 3-pin plug into the electrical outlet. *Avoid using extension cords*



11. Installation

The suction line is one of the most important aspects of any pump installation. Up to 90% of pump problems encountered are related to the suction line.

SUCTION LINE (Inlet pipe)

General rules

- Locate the pump as close to the water source as possible.
- Keep the suction line as short and straight as practical with a minimum of fittings, joins or elbows to minimise the risk of air leaks and to keep water friction low. Ensure the suction pipe is suitable and won't deform.
- Ensure there is at least 150mm of straight pipe entering the pump. Never fit an elbow directly to the pump inlet
- It is CRITICAL that the inlet piping is at least the same size as the inlet port (25mm)

Tank fed (water level higher than the pump)

- Fit an isolating valve (minimum 1" valve) to the outlet of the water tank. A ball valve is recommended for this application due to their superior reliability and fast action.
- 25mm inside diameter flexible suction hose a minimum of 300m long is recommended when connecting to a water tank. The flexible hose compensates for any movement in the installation that may occur.

Suction lift (water level lower than the pump)

- If the pump is located above the level of the water, a one-way valve (foot-valve) must be installed on the end of the suction line.
- To prevent the formation of air pockets, the suction hose must slope slightly upwards towards the pump.

DISCHARGE LINE (Outlet pipe)

- The **minimum** recommended discharge line is 20mm inside diameter pipe.
- If an elbow has to be fitted to the top of the controller, use a 25mm inside diameter elbow first then use a reducer to reduce friction losses.
- Small diameter pipes result in friction losses and can result in disappointing performance
- When fitting a discharge line to a garden tap, ensure that the tap is attached to either a wall or post as a permanent fixture and there is at least one metre of line between the pump and the tap. This will allow the controller to operate most efficiently.
- Avoid installing taps or connections directly above pump as this can allow water to be discharged directly onto the pump's motor in the event of a leak.

11. Installation con't

GENERAL INSTALLATION NOTES

Install the pump as close to the water source as practical and where it is easily accessible

Use plumbing fittings that make removal of pump for servicing possible.

Fitting inlet and outlet isolation valves will aid pump servicing or removal but also allows for fault diagnosis.

Protect the pump from weather, flooding or insect infestation.

If the region is frost-prone, protect the pump against freezing.

The pump unit is an electrical apparatus and therefore must be protected against moisture. Environmental temperature should not exceed 40°C

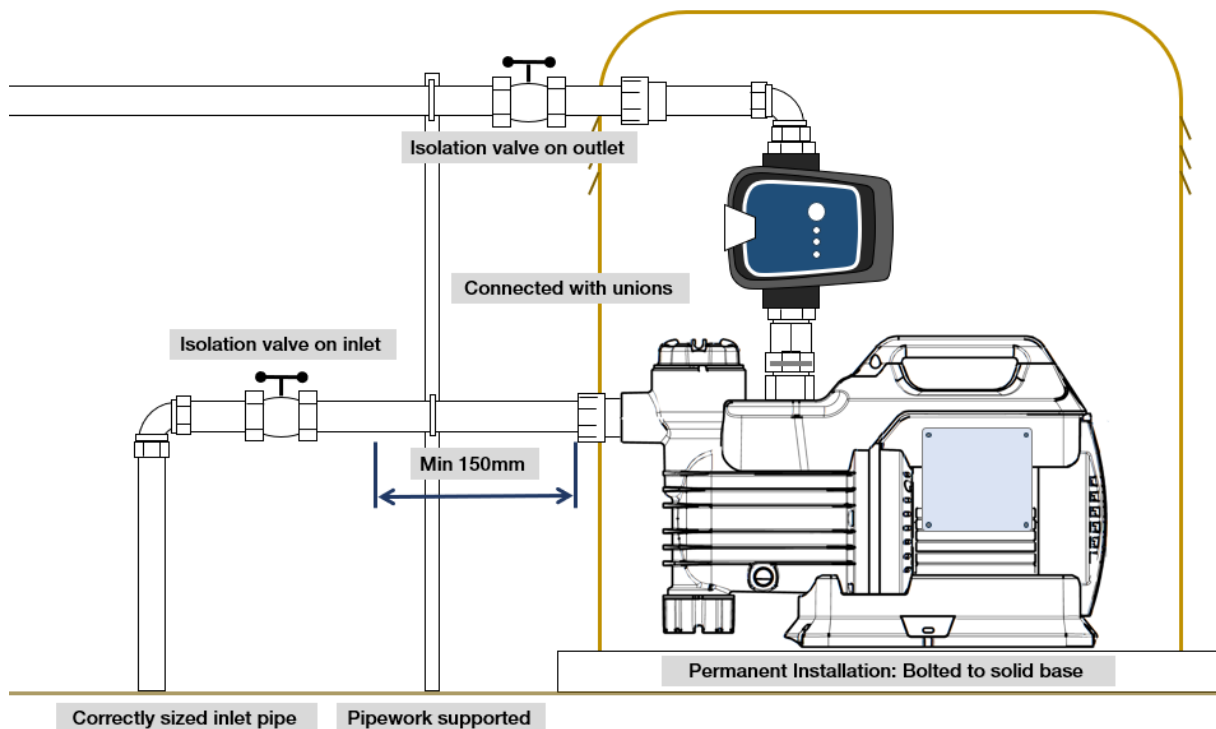

**Never run the pump before filling with water.
Running dry will damage the pump and void warranty.**

12. Operation



The pump controller will not start if the highest point of water delivery exceeds a vertical height of 15 meters above the pump.

INITIAL START UP AND PRIMING

Before putting the system into operation, fill the pump and suction line via the pre-filter lid.

If the level of the water to be pumped is below the level of the pump, ensure that the suction line is equipped with a non-return type foot-valve.

1. Open a tap slightly to allow air to escape and the water to flow when the pump starts.
2. Connect the pump unit to the electrical power outlet and turn the power on. The **'POWER ON'** LED will be on.
3. The pump starts automatically and the LED **'PUMP ON'** will be illuminate, indicating that the pump is operating. Allow the pump to operate for approximately 30 seconds to remove all air that may be in the system.
4. Close the tap. The pump should stop after approximately 20 seconds.

CONTROLLER OPERATION

The controller is programmed to perform all pump control operations automatically.

The pump starts automatically when the pressure falls below the 1.5 bar.

The pump will run continuously until the controller senses flow has fallen below approx. 1.2 liters per minute. The pump will run on for approx 20 seconds before switching off.

Dry Run Protection and Auto Restart

If no water is supplied to the system, i.e. no water in tank or closed supply/suction pipe, the system will run the following sequence:

- Switch off after 20 seconds if no water is detected
- stop for 10 seconds
- run for 40 seconds, stop for 10 seconds
- run for 40 seconds, stop for 10 seconds



The controller at this point will go into run a dry protection cycle. The **'POWER ON'** light will stay illuminated and the **'LACK OF WATER'** light will flash slowly.

When the **'LACK OF WATER'** light is flashing, it means the pump will restart after 24 hours. The system will repeat this cycle every 24 hours until water is detected.

The pump can be restarted at any time by pressing the **'RESET'** button

13. Maintenance and Cleaning

In normal circumstances the pump does not require any type of maintenance other than regular checks for leaks and cleaning to remove dust, spiderwebs etc

In the event of repairs or maintenance the pump must be disconnected from the power supply and the water supply isolated before starting.

When restarting the pump, ensure that it has been correctly reassembled, so as not to create a risk for persons and property.

Cleaning the suction filter

- Switch off the electric power supply to the pump
- Close the inlet isolation valve (if fitted)
- Drain the pump by opening the drainage bung
- Unscrew the cover of the filter chamber, with your hands or with an appropriately sized flat bladed screwdriver
- Extract the filter cartridge
- Rinse the cartridge under running water and clean with a soft brush
- Reinstall the filter into the pump
- Refill the pump with water before fitting the filter cap
- Open the isolation valve before turning the power back on

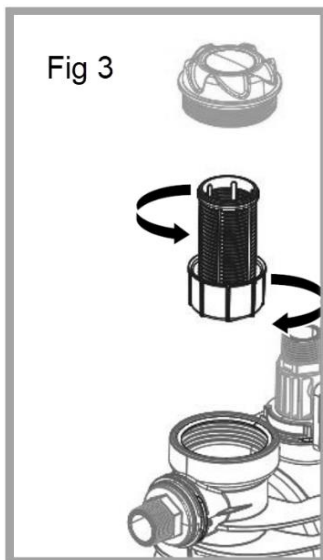

Fitting a modest 2, 8 or 18 litre pressure tank to the outlet/discharge line will prevent frequent and unnecessary pump restarts. The tank will improve the pump operation, reduce electrical energy energy wastage



Set pressure tank precharge to 66% of the max system pressure

14. Trouble Shooting



Before taking any troubleshooting action, disconnect the pump from the power supply (i.e. remove the plug from the socket).

| CLA – C3X / C5X | | |
|--|---|---|
| Problem | Possible Cause | Suggested Action |
| Pump doesn't stop once all taps/outlets are closed | There may be a leak in the pipe system (>1.2 lpm) | Close the discharge pipe isolation valve. If the pump stops after approx. 20 sec then the issue is a small water demand / leak somewhere. Check all pipework for leaks on both suction and discharge side of pump. Pressure test using a gauge if necessary. Any small leak from a connection, tap or leaking toilet etc. may cause a problem. |
| Pump starts but goes to failure (Lack of Water light on) | Pump has not primed or there is no water to pump | Re-prime pump. Make sure there is sufficient water to pump and no blockage in suction line. Press RESET button and try again. |
| Pump doesn't start and no LED's illuminated on the controller | No power to unit | Check power outlet is turned on. Check electrical connection and ensure electrical power is working. |
| Pump starts and stops repeatedly | The system is losing pressure due to a small leak in the system | Check all pipework for leaks on suction and discharge side of pump. Pressure test using a gauge if necessary. Any small leak from a connection, tap or leaking toilet will cause a problem. Fitting a small pressure tank (2 – 18 litres) will reduce pump start frequency |
| The pump 'hums' but the motor does not start | Check the condition of the capacitor. | Replace the capacitor. |
| The motor does not start but makes no noise. | Look for possible blockages or jamming in the pump or motor | Remove the blockage or obstruction |

White International is not responsible for the consequences of any unauthorized repairs and changes.



If the supply cord is damaged, the pump should be returned to White International or one of its Authorised Service Agents (contact www.whiteint.com.au or www.whiteint.co.nz) for repair in order to avoid potential injury/electrical shock.

15. Warranties – Terms and Conditions

This warranty is given in addition to the consumer guarantees found within the Australian Competition and Consumer Act 2010 (Cth) for goods purchased in Australia and the Consumer Guarantees Act 1993 NZ for goods purchased in New Zealand:



1) White International Pty Ltd / White International NZ Ltd (White International) warrant that all products distributed are free from defects in workmanship and materials, for their provided warranty period as indicated on the top or opposite side of this document. Subject to the conditions of the warranty, White International will repair any defective products free of charge at the premises of our authorised service agents throughout Australia and New Zealand if a defect in the product appears during the warranty period. If you believe that you have purchased a defective product and wish to make a claim under this warranty, contact us on our Sales Hotline on 1300 783 601, or send your claim to our postal address or fax line below and we will advise you as to how next to proceed. You will be required to supply a copy of your proof of purchase to make a claim under this warranty.

2) This warranty excludes transportation costs to and from White International or its appointed service agents and excludes defects due to non-compliance with installation instructions, neglect or misuse, inadequate protection against the elements, low voltage or use or operation for purposes other than those for which they were designed. For further information regarding the suitability of your intended application contact us on our Sales Hotline on 1300 783 601. If you make an invalid claim under this warranty, the original product will be sent back to you unrepai red.

3) This warranty refers only to products sold after the 1st January 2012, and is not transferable to another product type and only applies to the original owner, purchaser or end user, and is in addition to the consumer guarantees found within the Competition and Consumer Act 2010 (Cth) for goods purchased in Australia and the Consumer Guarantees Act 1993 (NZ) for goods purchased in New Zealand.

4) Our goods come with guarantees that cannot be excluded under the Australian Consumer Law. You are entitled to a replacement or refund for a major failure and for compensation for any other reasonably foreseeable loss or damage. You are also entitled to have the goods repaired or replaced if the goods fail to be of acceptable quality and the failure does not amount to a major failure. 3 YEAR WARRANTY

5) To the fullest extent permitted by law, White International excludes its liability for all other conditions or warranties which would or might otherwise be implied at law. To the fullest extent permitted by law, White International's liability under this warranty and any other conditions, guarantees or warranties at law that cannot be excluded, including those in the Competition and Consumer Act 2010 (Cth), is expressly limited to: (a) in the case of products, the replacement of the product or the supply of equivalent product, the payment of the cost of replacing the product or of acquiring an equivalent product or the repair of the product or payment of the cost of having the product repaired, is at the discretion of White International or a 3rd party tribunal elected under the Competition and Consumer Act 2010 (Cth) for goods purchased in Australia and the Consumer Guarantees Act 1993 (NZ) for goods purchased in New Zealand; and

6) To the fullest extent permitted by law, this warranty supersedes all other warranties attached to the product or its packaging.

7) In the case of services, supplying the services again or the payment of the cost of having the services supplied again, is at the discretion of White International or a 3rd party tribunal elected under the Competition and Consumer Act 2010 (Cth) for goods purchased in Australia and the Consumer Guarantees Act 1993 (NZ) for goods purchased in New Zealand. 8) Our warranty commences from the date of purchase of the above mentioned pumps. Proof of purchase is required before consideration under warranty is given.

Record your date of purchase in the space below and retain this copy for your records.

Date of Purchase**Model Purchased**



www.whiteint.com.au

www.whiteint.co.nz

Please always refer to our website for further technical information & new product innovations

Disclaimer: Every effort has been made to publish the correct information in this manual.
No responsibility will be taken for errors, omissions or changes in product specifications.

© 2024 Copyright White International Pty Ltd

TM ® - WARNING: Please be aware that various brands & products depicted within this document are subject to trademark, patent or design registrations. Infringement of any intellectual property contained within this document without express written authority by the appropriate intellectual property holder may result in further legal action to be taken. For any queries regarding use of the contained information please feel free to contact White International Pty Ltd.