

PRODUCT SPECIFICATIONS

# PACIFIC RISE 750 DOUBLE DWR WALL VANITY

NO HANDLE



## CABINET

INSTALLATION	Wall hung
CONFIGURATION	2 soft-close drawers
MATERIAL	Moisture resistant board
WIDTH (mm)	740
DEPTH (mm)	450
HEIGHT (mm)	550
ORIGIN	Aotearoa / New Zealand

## VANITY TOP

FINISH	Gloss White
MATERIAL	Vitreous China
TAP HOLE	Yes
OVERFLOW	Yes
WASTE SIZE	Suits 32mm and 40mm waste traps
WASTE INCLUDED	No
WIDTH (mm)	750
DEPTH (mm)	460
ORIGIN	PRC

## PRODUCT CODES & FINISHES



4PAC075DW01NH  
White Melamine



4PAC075DW23NH  
Baroque



4PAC075DW93NH  
Charred Oak

## NOTES

- 5 year warranty \*
- Cabinets made from moisture resistant board with PUR bonding technology are sustainably sourced from FSC certified NZ Radiata Pine.
- Optional - Pop-up Waste.\*\*

JUNE 2024

ALL MEASUREMENTS ARE NOMINAL.  
\*WARRANTIES APPLY TO RESIDENTIAL DOMESTIC USE ONLY. WARRANTY IS VOID IF PRODUCT IS NOT INSTALLED ACCORDING TO OUR SPECIFICATIONS.  
\*\*REFER TO WEBSITE FOR FURTHER INFORMATION ON INSTALLATION GUIDE AND PRODUCT OPTIONS.  
CLEARLITE.CO.NZ

PRODUCT SPECIFICATIONS

# PACIFIC RISE 750 DOUBLE DWR WALL VANITY

NO HANDLE

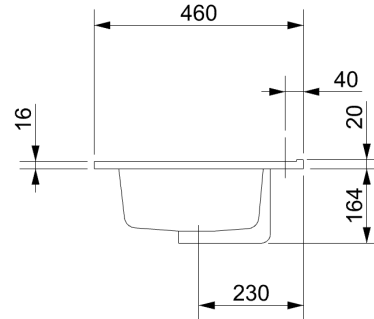
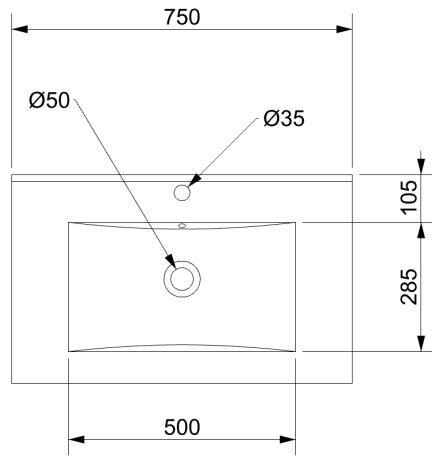

135 mm  
INTERNAL BASIN DEPTH

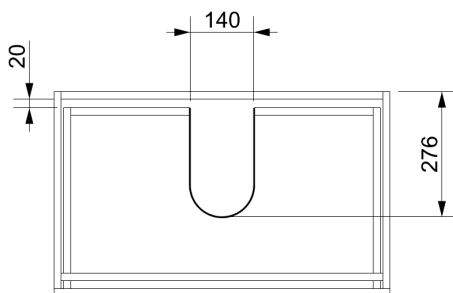
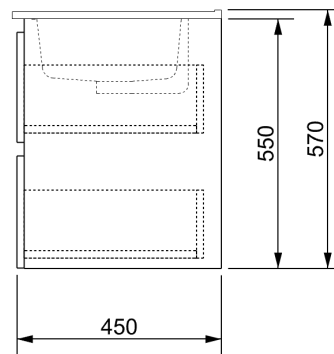
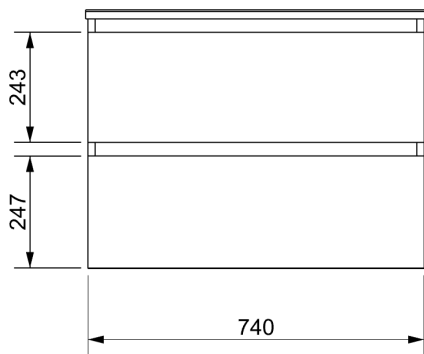
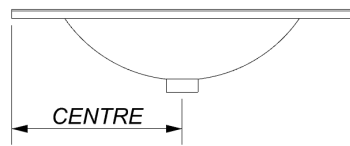

TOP DRAWER

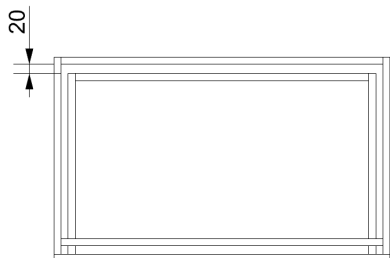

BOTTOM DRAWER

JUNE 2024

ALL MEASUREMENTS ARE NOMINAL.  
\*WARRANTIES APPLY TO RESIDENTIAL DOMESTIC USE ONLY. WARRANTY IS VOID IF PRODUCT IS NOT INSTALLED ACCORDING TO OUR SPECIFICATIONS.  
\*\*REFER TO WEBSITE FOR FURTHER INFORMATION ON INSTALLATION GUIDE AND PRODUCT OPTIONS.  
CLEARLITE.CO.NZ