

PRODUCT SPECIFICATIONS

PACIFIC 750 DOUBLE DWR FLOOR VANITY



PRODUCT CODES & FINISHES



4PAC075DF01
White Melamine



4PAC075DF23
Baroque



4PAC075DF93
Charred Oak

CABINET

INSTALLATION	Floor standing
CONFIGURATION	2 soft-close drawers
MATERIAL	Moisture resistant board
WIDTH (mm)	740
DEPTH (mm)	445
HEIGHT (mm)	788
ORIGIN	Aotearoa / New Zealand

VANITY TOP

FINISH	Gloss White
MATERIAL	Vitreous China
TAP HOLE	Yes
OVERFLOW	Yes
WASTE SIZE	Suits 32mm and 40mm waste traps
WASTE INCLUDED	No
WIDTH (mm)	750
DEPTH (mm)	460
ORIGIN	PRC

NOTES

- 5 year warranty *
- Cabinets made from moisture resistant board with PUR bonding technology are sustainably sourced from FSC certified NZ Radiata Pine.
- Included - Brushed Nickel handle(s).
- Optional - Pop-up Waste.**

MAY 2024

ALL MEASUREMENTS ARE NOMINAL.
*WARRANTIES APPLY TO RESIDENTIAL DOMESTIC USE ONLY. WARRANTY IS VOID IF PRODUCT IS NOT INSTALLED ACCORDING TO OUR SPECIFICATIONS.
**REFER TO WEBSITE FOR FURTHER INFORMATION ON INSTALLATION GUIDE AND PRODUCT OPTIONS.
CLEARLITE.CO.NZ

PACIFIC 750 DOUBLE DWR FLOOR VANITY

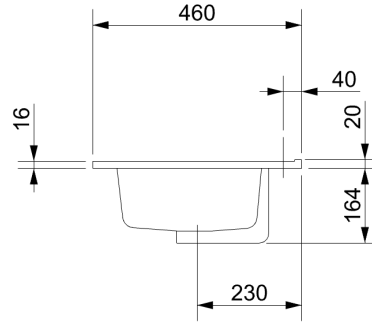
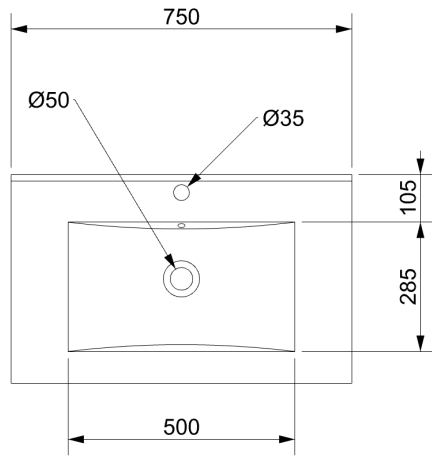

135 mm
INTERNAL BASIN DEPTH

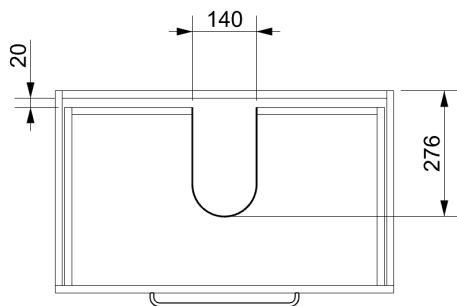
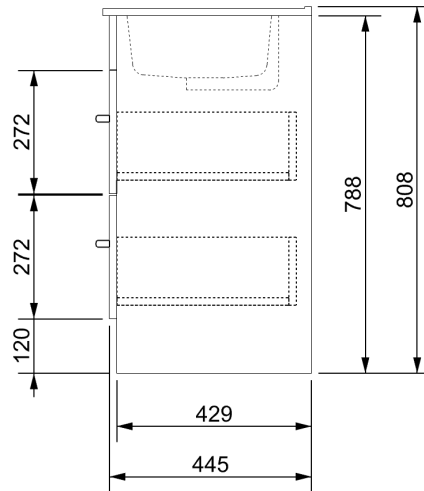
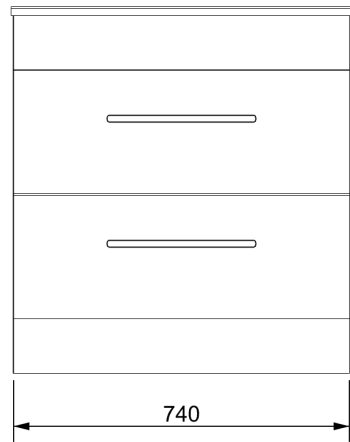
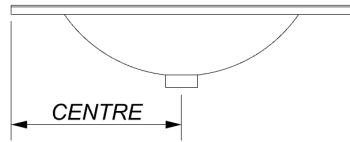

TOP & BOTTOM
DRAWER

MAY 2024

ALL MEASUREMENTS ARE NOMINAL.
*WARRANTIES APPLY TO RESIDENTIAL DOMESTIC USE ONLY. WARRANTY IS VOID IF PRODUCT IS NOT
INSTALLED ACCORDING TO OUR SPECIFICATIONS.
**REFER TO WEBSITE FOR FURTHER INFORMATION ON INSTALLATION GUIDE AND PRODUCT OPTIONS.
CLEARLITE.CO.NZ