

# Round Metal Project Shower Rail 4 Star Rating

# Nero

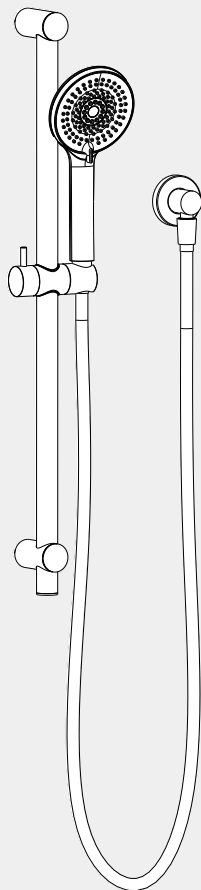

Versions:202311

## Drawing

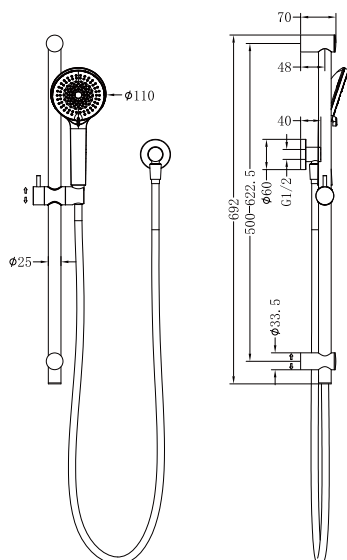

## Specifications

### SKU

NR319

### Watermark License

WM-060093

### Temperature Rating

Min 1°C-Max 75°C

### Pressure Rating

Min 150kpa - Max 500kpa

## Finish

Chrome  
NR319CH

Matte Black  
NR319MB

Gun Metal  
NR319GM



Brushed Gold  
NR319BG

Brushed Nickel  
NR319BN

## Packaging Includes

- 1x Handle Shower (Built-In Check Valve)
- 1x Shower Hose
- 1x Elbow
- 1x Shower Rail

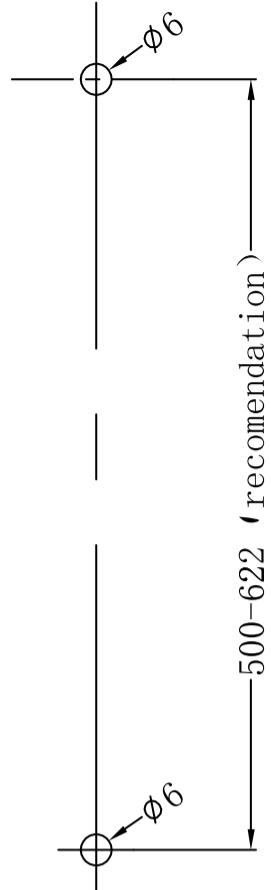
\*Dimensions are nominal measurements only.

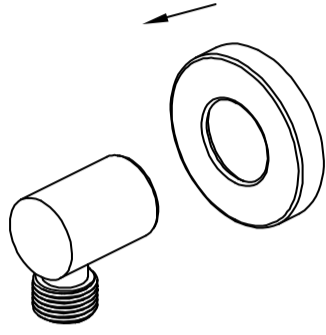
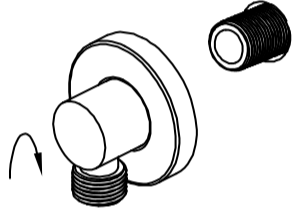
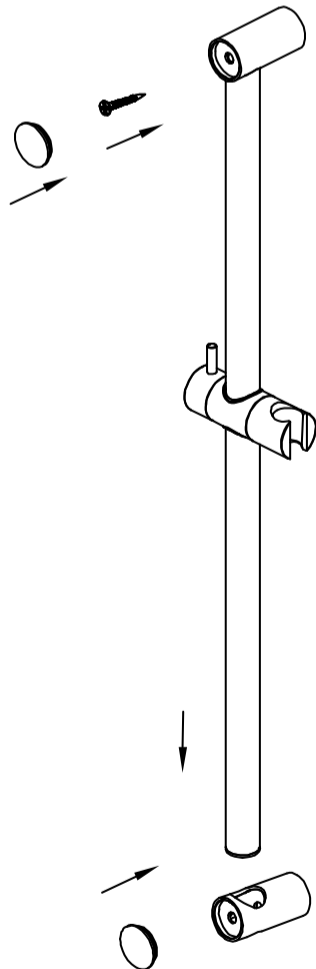
<p>use Teflon tape</p>  <p>1. Put Teflon tape on outlet thread.</p>	 <p>4. Drill two <math>\phi 6</math>mm holes according to above picture.</p>	 <p>5. Mount bottom bracket on the <math>\phi 6</math> hole by expansion plug and tapping screw.</p>
 <p>2. Pull dressing ring on the elbow body.</p>		 <p>7. Connect hand shower with outlet by shower hose</p> <p>8. Test for leaks.</p>
 <p>3. Screw elbow body on to outlet.</p>		
 <p>6. Plug shower rail in bottom bracket. Mount top bracket on the top hole by expansion plug and tapping screw. Push plates onto two brackets.</p>		

# Nero

info@nerotapware.com.au  
nerotapware.com.au

11-13 Buontempo Road  
Carrum Downs Vic 3201

