

## ***Dolce*** Bathroom Accessories

Versions:202311

### Finish

---



Chrome



Matte Black



Brushed Nickel

## Dolce Bathroom Accessories

**ROBE HOOK**  
NR3682CH/NR3682MB/NR3682BN

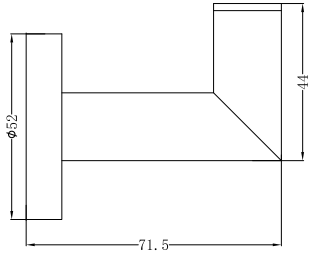

**DOLCE HAND TOWEL RAIL**  
NR3680CH/NR3680MB/NR3680BN

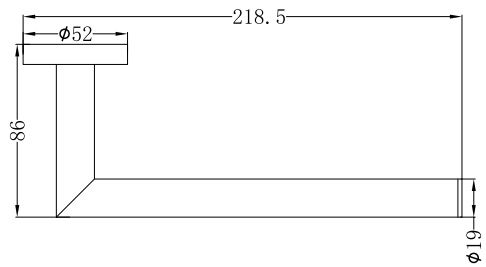

**DOLCE SINGLE TOWEL RAIL 900MM**  
NR3630ICH

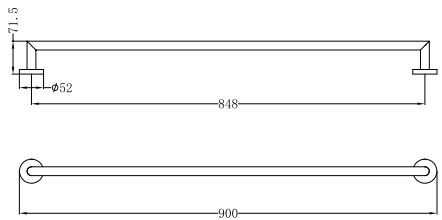

**DOLCE DOUBLE TOWEL RAIL 900MM**  
NR3630dICH

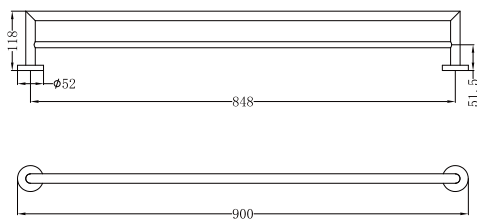

**DOLCE TOILET BRUSH HOLDER**  
NR3688CH

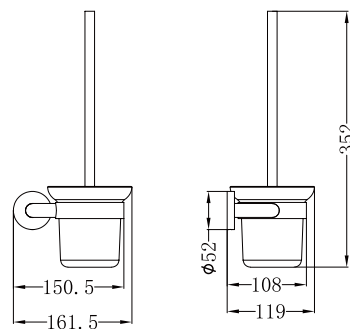

**DOLCE SINGLE TOWEL RAIL 700MM**  
NR3630CH/NR3630MB/NR3630BN

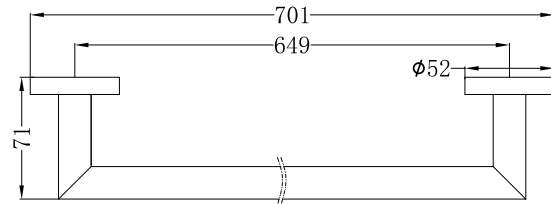

**DOLCE TOILET ROLL HOLDER**  
NR3686wCH/NR3686wMB/NR3686wBN

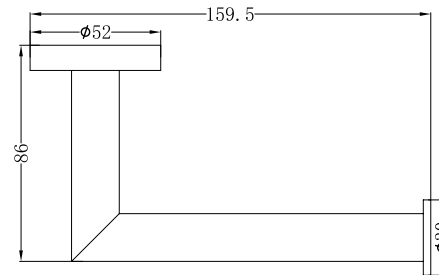

**DOLCE DOUBLE TOWEL RAIL 700MM**  
NR3630dCH/NR3630dMB/NR3630dBN

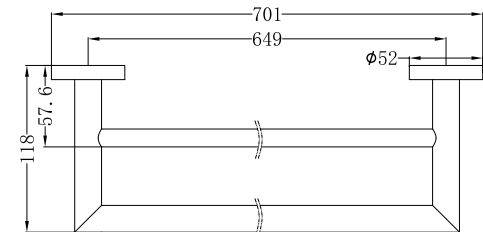

**DOLCE METAL SHOWER SHELF**  
NR3687aCH/NR3687aMB/NR3687aBN

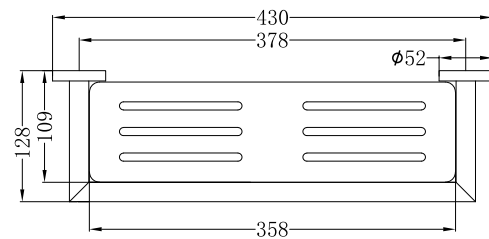

## Installation Instruction

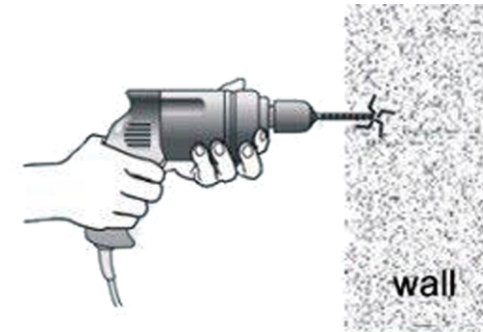

1. Put the fixing blocks (piece) over on the right place on the wall, and stay level, use marking pen through the holes of fixing block to mark out fixing spots on the wall. Then drill holes by electric hand drill with 6mm drilling bit on the spots.

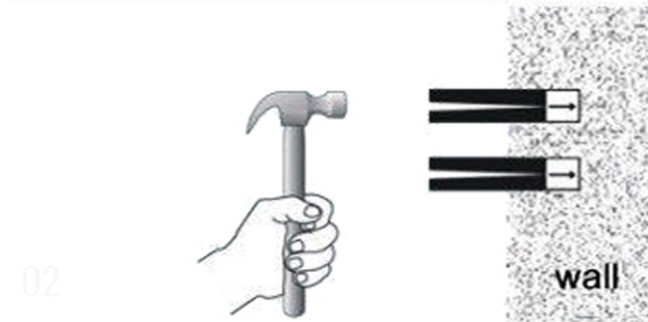

2. Put the expansion plugs into the wall by hammer.

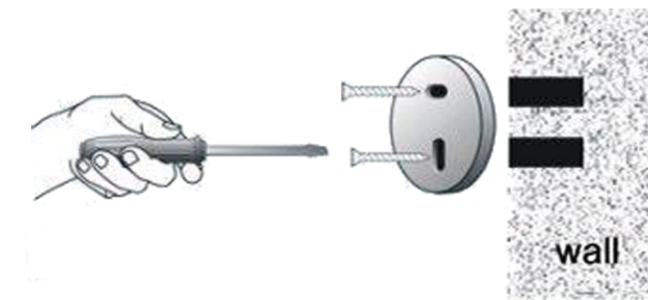

3. Put fixing block cover on the holes and fix firmly by expansion screws.

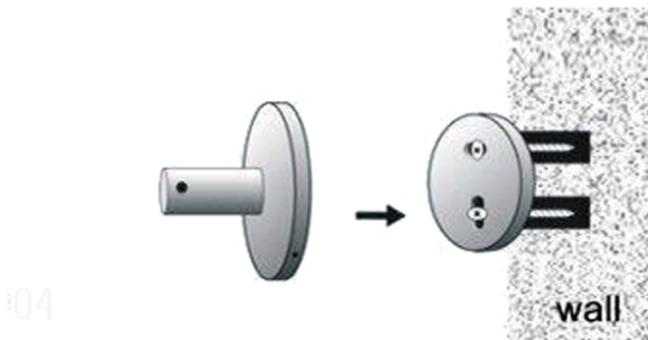

4. Put the base of bathroom accessory cover on the fixing blocks.

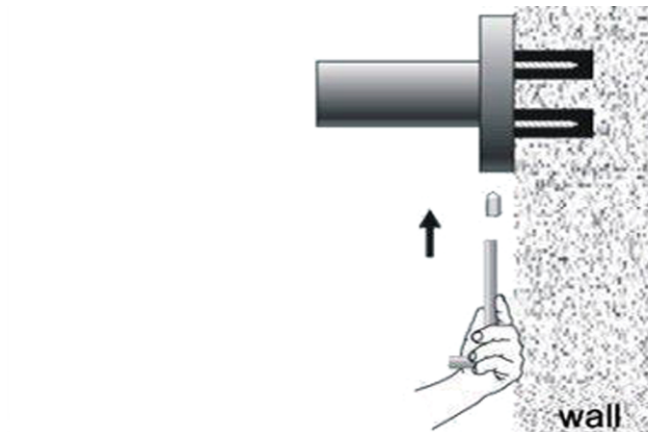

5. Screw grub screws into the base, make it against to the fixing block tight and firm.

# Nero

[info@nerotapware.com.au](mailto:info@nerotapware.com.au)  
[nerotapware.com.au](http://nerotapware.com.au)

11-13 Buontempo Road  
Carrum Downs Vic 3201

