

Opal Shower Rail With Air Shower II

Nero

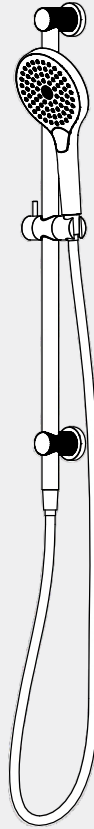

Versions:202401

Drawing

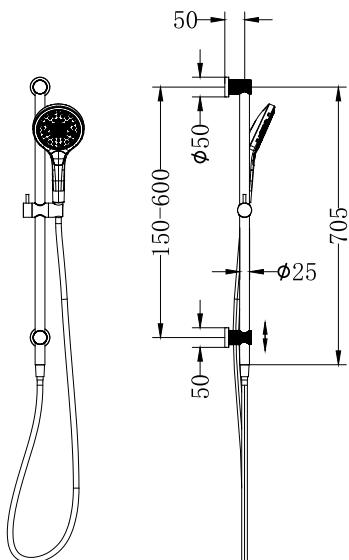

Specifications

Watermark License

WM-060093





Temperature Rating

Min 1°C-Max 75°C

Pressure Rating

Min 150kpa - Max 500kpa

Finish & SKU

- | | |
|--------------------------------------------------------------------------------------------------------------------------|--------------------------------------------------------------------------------------------------------------------------|
|  Brushed Bronze
NR251905gBZ |  Brushed Nickel
NR251905gBN |
|  Graphite
NR251905gGR |  Brushed Gold
NR251905gBG |

Packaging Includes

- 1x Hand Shower (Built- In Check Valve)
- 1x 1.5m PVC Hose
- 1x Shower Rail

*Dimensions are nominal measurements only.

Important

All products must be installed by licensed plumbers.

All pipework must be thoroughly flushed prior to installation, as foreign materials may block the flow regulating device and reduce the flow of water.

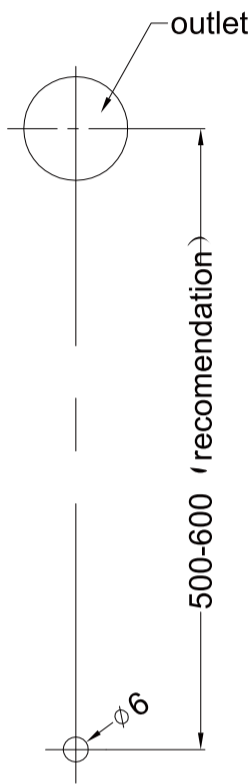

1. Drill a $\phi 6$ mm hole at the downwards outlet vertical downward position in the recommendation range.

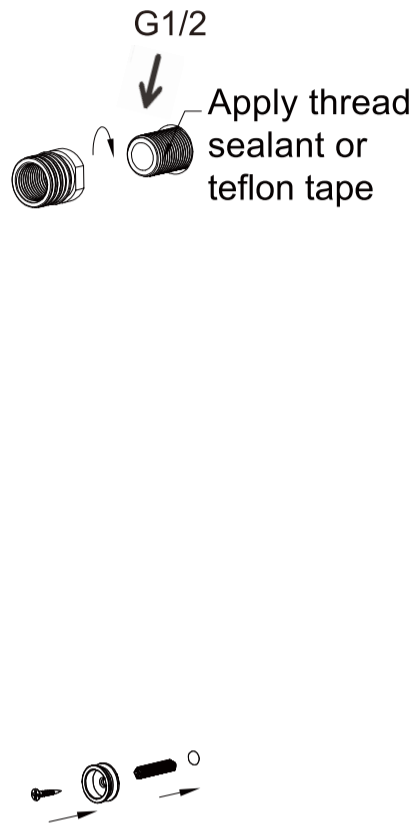

2. Screw the adapter onto the outlet. Push wall plug into drilled hole. Fit lower mounting pillar in place with screw. Tighten firmly.

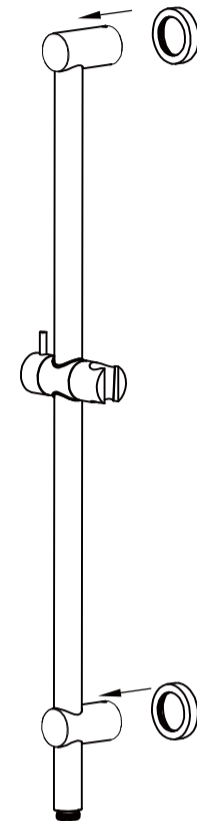

3. Slide both top and bottom back plate onto the rail assembly, as shown on the picture.

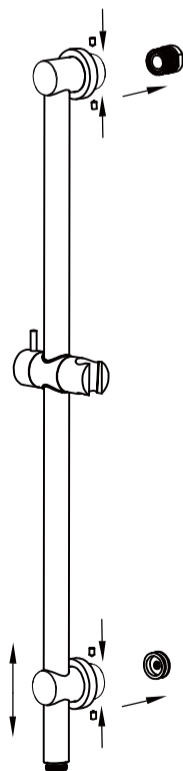

4. Push shower rail assembly onto the wall/tile face. Tighten grub screws firmly. Slide the back plates against the wall/tile face properly.

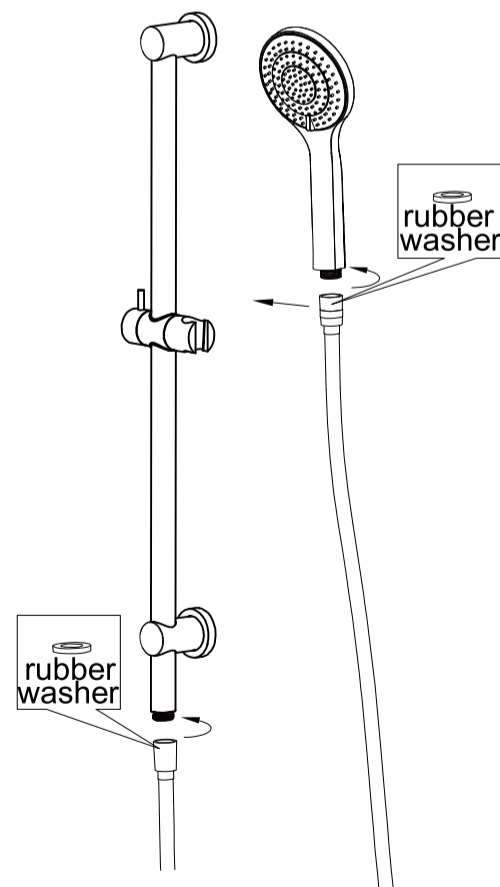

5. Connect shower rail and hand shower with hose. TEST & CHECK FOR LEAKS.

Nero

info@nerotapware.com.au
nerotapware.com.au

11-13 Buontempo Road
Carrum Downs Vic 3201

