

Mecca Care 32mm DDA Grab Rail Set 45 /90 Degree

Nero

45 degree

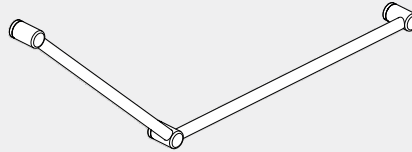

90 degree

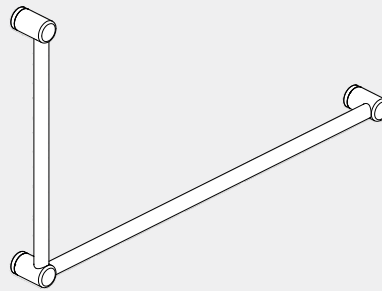

Versions:202401

Drawing

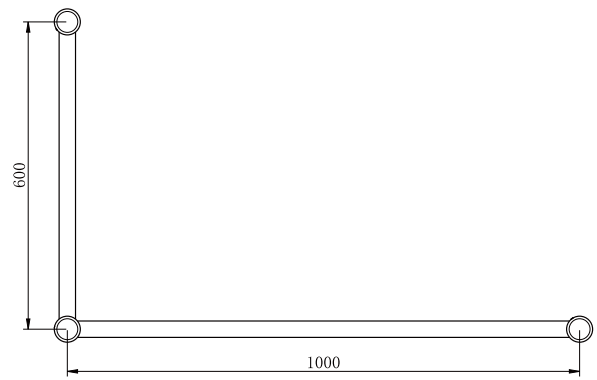
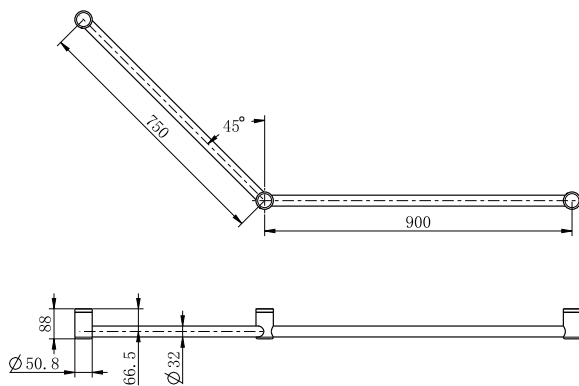

Warning:





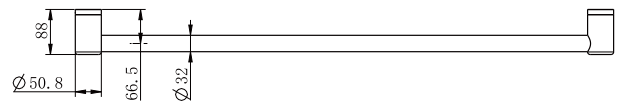

These rails are designed to be mounted onto wall studs or masonry walls. Installation is recommended to be completed by qualified trades person who complies with the AS 1428.1-2009 design for access and mobility standard. It is recommended rail location is determined by a qualified occupational therapist or trained professional to the AS 1428.1-2009 standard. Correct installation is required to ensure safe, long term operation. Incorrect mounting can result in reduced capacity of the rail which can result in injury to user and damage to the wall.

Features

1. Australian owned and designed.
2. Sizes: 45 / 90 degree as standard.
3. Can be mounted on left or right hand side.
4. Optional add on toilet roll holder attaches to the 32mm rail
3. Modular design, the rail to be mounted horizontally, vertically or at any angle and cut down to suit your bathroom.
5. 150kg capacity for all 25mm and 32mm diameter grab rails.
6. 32mm diameter rails are approved for standard AS1428.1 requirements in DDA bathrooms.
7. Gun metal, brushed gold and brushed bronze colours are PVD coated for long term durability.



Finish & SKU

 Chrome NRRCR3245CH/NRRCR3290CH	 Gun Metal NRRCR3245GM/NRRCR3290GM	 Brushed Bronze NRRCR3245BZ/NRRCR3290BZ
 Matte Black NRRCR3245MB/NRRCR3290MB	 Brushed Gold NRRCR3245BG/NRRCR3290BG	 Brushed Nickel NRRCR3245BN/NRRCR3290BN

*Dimensions are nominal measurements only.

Installation Instruction

<p>make hole positions</p> <p>SIDE VIEW</p>	<p>1. Locate wall studs, install into at least one stud. Place wall seal/mounting bracket on wall at correct height over centre of stud and mark hole positions on wall refer left picture. (minimum 2 supplied screws per bracket).</p> <p>Tip: Rail height is 790mm above the ground.</p>
<p>wall plugs</p>	<p>2. Drill pilot holes into wall stud approximately 60mm deep to suit mounting screws (and wall plugs if required).</p> <p>Tip: 3mm hole for screws into timber or 8mm hole for wall plugs.</p>
	<p>3. Apply small amount of silicon to mounting bracket and wall in and around the screw holes.</p>
	<p>4. Install mounting brackets by screwing onto wall.</p> <p>Tip: Use appropriate mounting screws for the wall stud material, supplied screws are for timber wall studs.</p>
	<p>5. Slide rail tubes into end brackets and push onto wall brackets, refer to left picture.</p> <p>Tip: Rail length can be cut down to a smaller size, simply use an angle grinder, hacksaw or pipe cutter then deburr the end with a file or grinder and reinsert into the end bracket.</p>
	<p>6. Tighten grub screws with allen key.</p> <p>Tip: If rail rattles, loosen end bracket, twist slightly and tighten.</p>
<p>90 Degree Set 45 Degree Set</p>	<p>7. Finished.</p> <p>SIDE VIEW FRONT VIEW</p>

Nero

info@nerotapware.com.au
nerotapware.com.au

11-13 Buontempo Road
Carrum Downs Vic 3201



**MECCA CARE
DDA CARE 32MM**