

Celia New Shower Rail

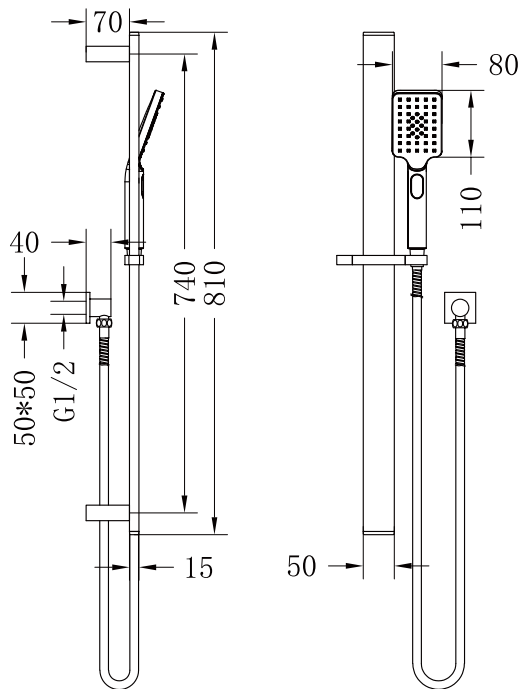





Dimensions are nominal measurements only.

SPECIFICATION

WELS RATING	5 STAR 6L/MIN
WATERMARK LICENSE	WM-060093
TEMPERATURE RATING	MIN 1°C-MAX 75°C
PRESSURE RATING	MIN 150KPa-MAX 500KPa

AVAILABLE FINISH

	CHROME NR316CH		MATTE BLACK NR316MB
	BRUSHED NICKEL NR316BN		GUN METAL NR316GM
	BRUSHED GOLD NR316BG		

MAINTENANCE AND CARE

All surfaces should be cleaned with mild liquid detergent or soap and water. Do not use cream cleaners or citrus based cleaning products, as they are abrasive. Use of unsuitable cleaning agents may damage the surface. Any damage caused in this way will not be covered by warranty.

PACKING INCLUDES

- 1x handle shower (built-in check valve)
- 1x shower hose
- 1x elbow
- 1x shower rail



Versions: V1



1. Put Teflon tape on outlet thread.

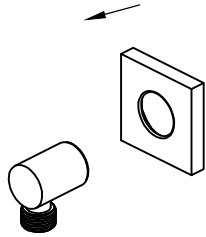

2. Pull dressing ring on the elbow body.

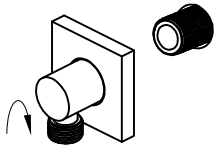

3. Screw elbow body on to outlet.

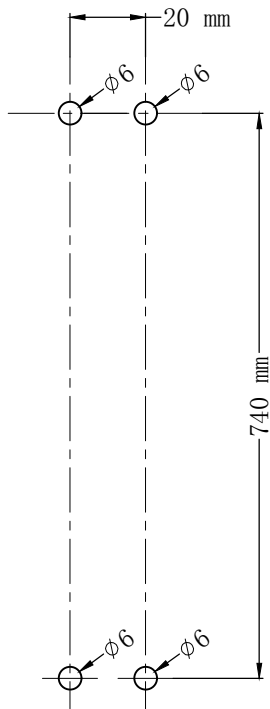

4. Drill four holes according to above picture.

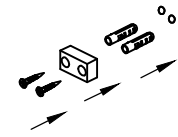
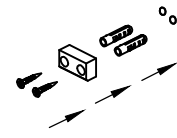

5. Make expansion plug into four holes and make brackets into holes by tapping screw.

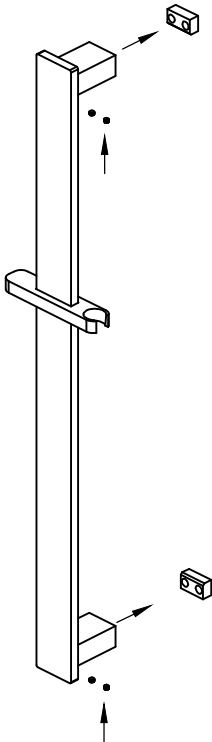

6. Install shower rail onto brackets, tighten four grub screws by hex wrench.

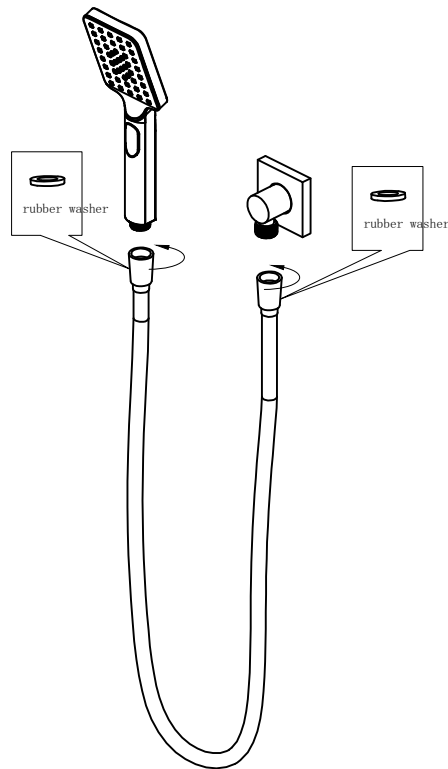

7. Connect hand shower and elbow by shower hose.
(Notes: there are two rubber washers in shower hose.)

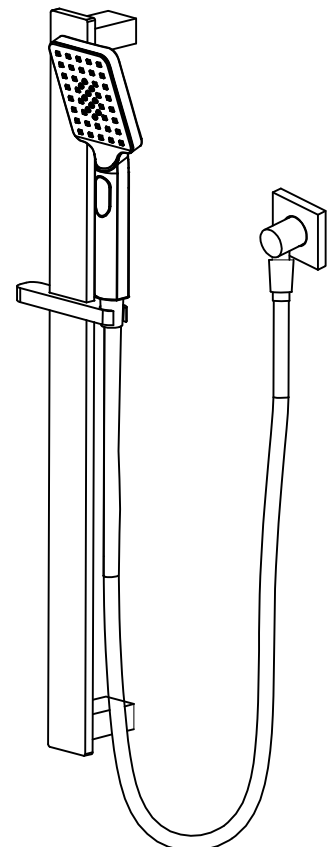

8. Test and check for leaks.