

# Mecca Care 25mm Grab Rail With Shelf 300/450mm

# Nero

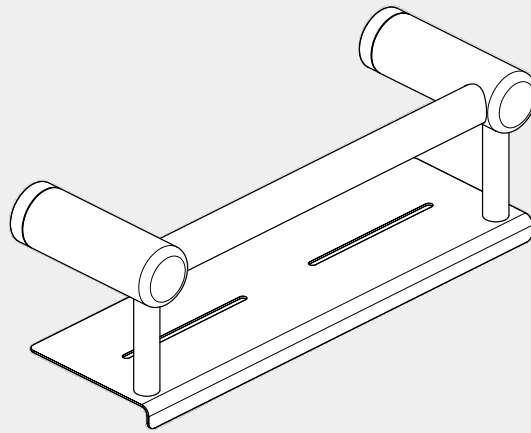

Versions:202311

## Drawing

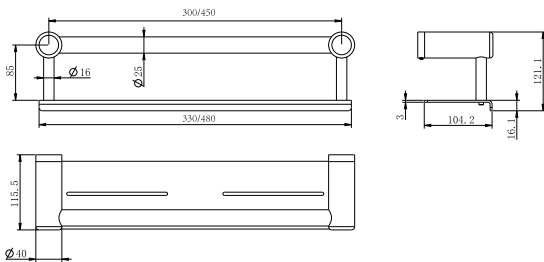

## Specifications

### SKU

300mm Length:NRCR2512c

450mm Length:NRCR2518c

### Warning:

These rails are designed to be mounted onto wall studs or masonry walls. Installation is recommended to be completed by qualified trades person who complies with the AS 1428.1-2009 design for access and mobility standard. It is recommended rail location is determined by a qualified occupational therapist or trained professional to the AS 1428.1-2009 standard. Correct installation is required to ensure safe, long term operation. Incorrect mounting can result in reduced capacity of the rail which can result in injury to user and damage to the wall.

### Finish



- Chrome**  
NRCR2512cCH/NRCR2518cCH
- Gun Metal**  
NRCR2512cGM/NRCR2518cGM
- Brushed Bronze**  
NRCR2512cBZ/NRCR2518cBZ
- Matte Black**  
NRCR2512cMB/NRCR2518cMB
- Brushed Gold**  
NRCR2512cBG/NRCR2518cBG
- Brushed Nickel**  
NRCR2512cBN/NRCR2518cBN

## Features

1. Australian owned and designed.
2. Handy 300mm Rail with a shelf suitable for shampoo bottles and soap.
3. Comfortable 25mm diameter rail.
4. 25mm diameter rails are suitable for support rails and smaller hands in private and non-DDA bathrooms.
5. Gun metal, brushed gold and brushed bronze colours are PVD coated for long term durability.

\*Dimensions are nominal measurements only.

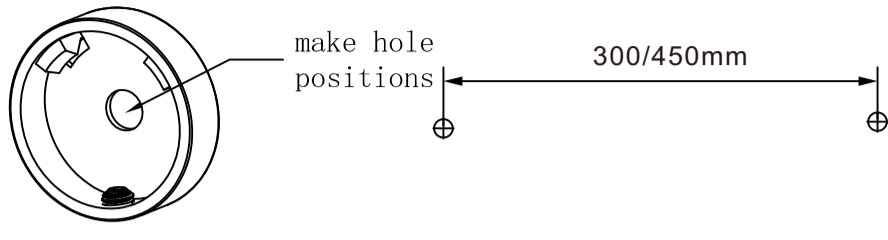
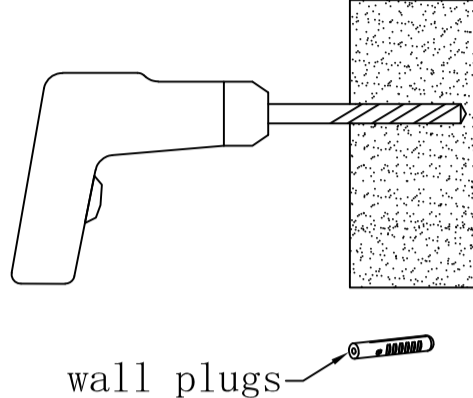
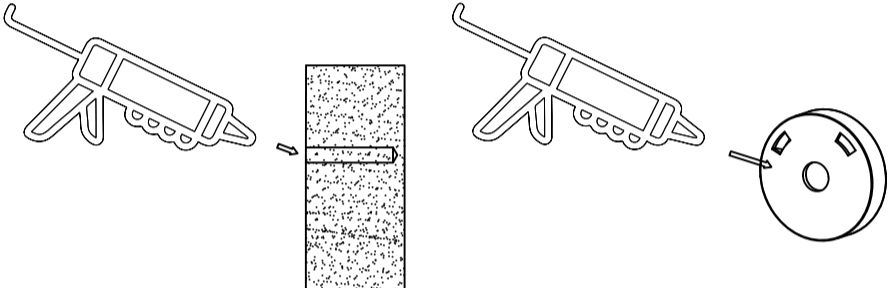
# Installation Instruction

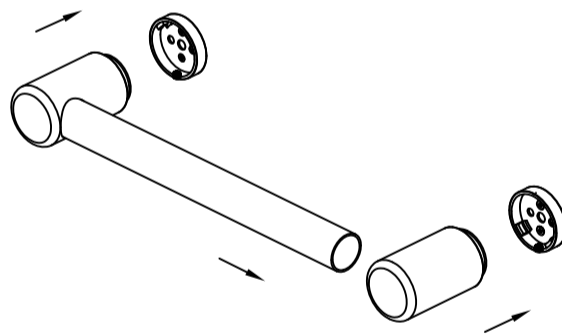
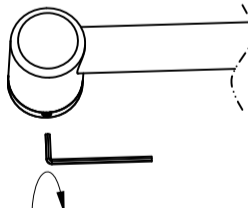
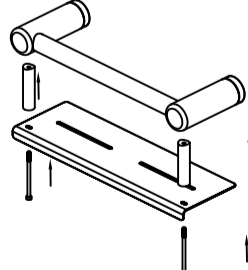
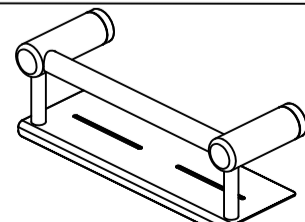
	<p>1. Locate wall studs, install into at least one stud. Place wall seal/mounting bracket on wall at correct height over centre of stud and mark hole positions on wall.</p>
	<p>2. Drill pilot holes into wall stud approximately 60mm deep to suit mounting screws (and wall plugs if required). Tip: 4mm hole for screws into timber or 10mm hole for wall plugs.</p>
	<p>3. Apply small amount of silicon to mounting bracket and wall in and around the screw holes.</p>
	<p>4. Install mounting brackets by screwing onto wall. Tip: Use appropriate mounting screws for the wall stud material, supplied screws are for timber wall studs.</p>
	<p>5. Slide rail tube into end bracket and push onto wall brackets.</p>
	<p>6. Tighten grub screws with allen key. Tip: If rail rattles, loosen end bracket, twist slightly and tighten.</p>
	<p>7. Using supplied allen key whilst holding the shelf in place refer to left picture, screw the M4*72mm screws into the grab rail till tight.</p>
	<p>8. Finished.</p>

# Nero

[info@nerotapware.com.au](mailto:info@nerotapware.com.au)  
[nerotapware.com.au](http://nerotapware.com.au)

11-13 Buontempo Road  
Carrum Downs Vic 3201



**MECCA CARE**  
**ASSISTED LIVING 25MM**