

TERRA LANA
WOOL INSULATION
PRODUCT DATA

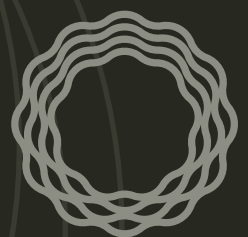

TERRA LANA

TERRA LANA WOOL INSULATION **PRODUCT TABLE**

All products are available in customised widths, lengths and R-values for orders over 50m²

R-VALUE	THICKNESS	CENTRES	BALE CONTAINS	M ² /BALE	CODE
CEILING SERVICE CAVITY					
R0.9	35mm	600mm	2 x 6m x 570mm	6.84 m ²	09.35.570
R1.2	45mm	600mm	2 x 5m x 570mm	5.70 m ²	12.45.570
R2.4	90mm	600mm	10 x 1.2m x 560mm	6.72 m ²	24.90.560
SKILLION ROOF – Can also be used in Truss roof					
R3.6	140mm	600mm	8 x 1.2m x 560mm	5.38 m ²	36.140.560
R5.0	190mm	600mm	5 x 1.2m x 570mm	3.42 m ²	50.190.570
R6.4	240mm	600mm	4 x 1.2m x 570mm	2.74 m ²	64.240.570
R7.2	290mm	600mm	4 x 1.2m x 570mm	2.74 m ²	72.290.570
TIMBER I-BEAM RAFTER 'FILLET' – Custom fillets available for all hyJOIST and Lumberworx I-Beams – see our website					
R0.9	35mm	200mm hyJOIST	8 x 6m x 120mm	48 lm/bale	09.35.120F
R0.9	35mm	240mm hyJOIST	7 x 6m x 160mm	42 lm/bale	09.35.160F
TRUSS ROOF					
R3.6	180mm	900mm	10 x 1.2m x 435mm	5.22 m ²	36.180.435
R4.0	190mm	900mm	10 x 1.2m x 435mm	5.22 m ²	40.190.435
TRUSS ROOF DOUBLE LAYER					
R5.2 (R2.6 + R2.6)	290 mm	900mm	12 x 1.2m x 435mm	3.13 m ²	26.145.435
R6.4 (R3.2 + R3.2)	330 mm	900mm	10 x 1.2m x 435mm	2.61 m ²	32.165.435
R7.2 (R3.6 + R3.6)	360mm	900mm	10 x 1.2m x 435mm	2.61 m ²	36.180.435
R8.0 (R4.0 + R4.0)	380mm	900mm	10 x 1.2m x 435mm	2.61 m ²	40.190.435
WALL SERVICE CAVITY					
R1.2	45mm	600mm	2 x 5m x 570mm	5.70 m ²	12.45.570
90mm WALL					
R2.4	90mm	400mm	10 x 1.2m x 360mm	4.32 m ²	24.90.360
R2.4	90mm	600mm	10 x 1.2m x 560mm	6.72 m ²	24.90.560
140mm WALL					
R3.2	140mm	400mm	10 x 1.2m x 360mm	4.32 m ²	32.140.360
R3.2	140mm	600mm	10 x 1.2m x 560mm	6.72 m ²	32.140.560
R3.6	140mm	400mm	10 x 1.2m x 360mm	4.32 m ²	36.140.360
R3.6	140mm	600mm	8 x 1.2m x 560mm	5.38 m ²	36.140.560
CHATTERBLOCK ACOUSTIC – For internal walls and midfloor					
R1.4	60mm	600mm	12 x 1.2m x 560mm	8.06 m ²	CB.60.560
R2.2	90mm	600mm	12 x 1.2m x 560mm	8.06 m ²	CB.90.560
R3.2	140mm	600mm	10 x 1.2m x 560mm	6.72 m ²	CB.140.560
RETRO-FIT UNDERFLOOR – Stapled in from underneath					
R2.0	115mm	450mm	2 x 5.6m x 480mm	5.38 m ²	20.115.480
NEW BUILD DROP-IN UNDERFLOOR – Install from above with propriety fastening system, prior to sheet flooring					
R2.7	110mm	400mm	8 x 1.2m x 365mm	3.50 m ²	DIF.110.365
R3.2	140mm	400mm	8 x 1.2m x 365mm	3.50 m ²	DIF.140.365

- Products must be removed from packaging within 3 months to ensure full loft recovery
- Orders of 4 bales or less are subject to additional freight charges.
- Prices are FIS excluding GST; site delivery not included unless otherwise stated.
- Please allow up to 2 - 3 weeks from order placement to delivery. Minimum order quantities may apply.
- Returns Policy: Returned products must be returned to our Christchurch Factory in original unopened packaging, within 1 month of the purchase date; The customer is responsible for the freight on all returns; Custom made products are non-refundable; a 20% restocking fee is charged against the gross value of the returned products less freight (ex factory cost).

v-SEP2023



0800 485 262

sales@terralana.co.nz | terralana.co.nz

55 Francella St, Christchurch, NZ



TERRA LANA

SKILLION ROOF WOOL INSULATION



TERRA LANA

PRODUCT DATA

The benefits of Terra Lana wool's superior performance designed for Skillion ceilings

APPLICATIONS

- Skillion roof (Truss roof or external walls where applicable)
- New and retrofit
- Residential and commercial buildings

FEATURES

- Designed to not slump or lose loft
- Superior insulative performance
- 100% recyclable (by Terra Lana)
- Easy to install, manufactured to fit
- Environmentally responsible product
- Naturally safe to handle & healthy in the home
- Manages moisture, maintaining thermal performance
- Excellent acoustic barrier qualities.

DESCRIPTION

Terra Lana harnesses all the benefits of wool's unique insulative qualities combined with innovative design for a truly high-performance skillion roof insulation. We use natural and recycled materials and manufacture locally to modern sustainability standards.

COMPLIANCE

- BRANZ APPRAISED. Appraisal 682 [2022]
- DECLARE RED LIST FREE. Certified toxin free
- GREENGUARD. Indoor air quality test approved
- HOMESTAR/GREENSTAR. Credits available
- EPD (in process for mid 2024 completion)
- QUALITY ASSURANCE. 50 year warranty

SPEC ASSIST

- Masterspec
- Smart Spec
- Design Navigator
- H1 Reports & spec writing

Contact: spec@terralana.co.nz

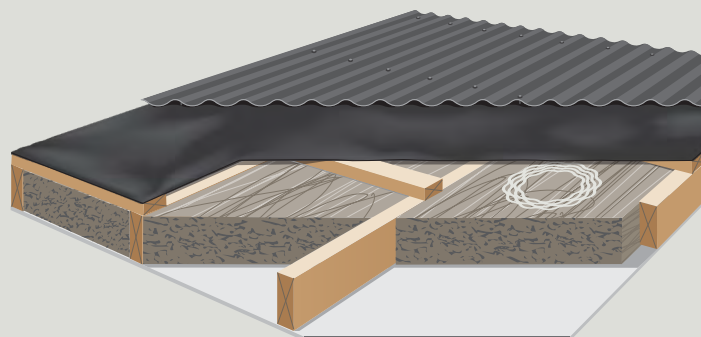

SPECIFICATIONS

R-VALUE	THICKNESS	CENTRES	BALE CONTAINS	M ² PER BALE	CODE
CEILING SERVICE CAVITY INSULATION					
R0.9	35mm	600mm	2 x 6m x 570mm	6.84 m ²	09.35.570
R1.2	45mm	600mm	2 x 5m x 570mm	5.70 m ²	12.45.570
R2.4	90mm	600mm	10 x 1.2m x 560mm	6.72 m ²	24.90.560
SKILLION ROOF INSULATION					
R3.6	140mm	600mm	8 x 1.2m x 560mm	5.38 m ²	36.140.560
R5.0	190mm	600mm	5 x 1.2m x 570mm	3.42 m ²	50.190.570
R6.4	240mm	600mm	4 x 1.2m x 570mm	2.74 m ²	64.240.570
R7.2	290mm	600mm	4 x 1.2m x 570mm	2.74 m ²	72.290.570



0800 485 262 | sales@terralana.co.nz | terralana.co.nz

TRUSS ROOF WOOL INSULATION



TERRA LANA

PRODUCT DATA

The benefits of Terra Lana wool's superior performance designed for Truss roof ceilings

APPLICATIONS

- Truss roof (Skillion roof or external walls where applicable)
- New and retrofit
- Residential and commercial buildings

FEATURES

- Designed to not slump or lose loft
- Superior insulative performance
- 100% recyclable (by Terra Lana)
- Easy to install, manufactured to fit
- Environmentally responsible product
- Naturally safe to handle & healthy in the home
- Manages moisture, maintaining thermal performance
- Excellent acoustic barrier qualities.

DESCRIPTION

Terra Lana harnesses all the benefits of wool's unique insulative qualities combined with innovative design for a truly high-performance truss roof insulation. We use natural and recycled materials and manufacture locally to modern sustainability standards.

COMPLIANCE

- BRANZ APPRAISED. Appraisal 682 [2022]
- DECLARE RED LIST FREE. Certified toxin free
- GREENGUARD. Indoor air quality test approved
- HOMESTAR/GREENSTAR. Credits available
- EPD (in process for mid 2024 completion)
- QUALITY ASSURANCE. 50 year warranty

SPEC ASSIST

- Masterspec
- Smart Spec
- Design Navigator
- H1 Reports & spec writing

Contact: spec@terralana.co.nz

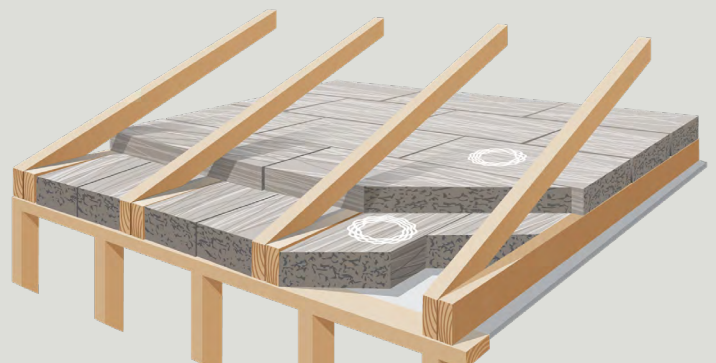

SPECIFICATIONS

R-VALUE	THICKNESS	CENTRES	BALE CONTAINS	M ² PER BALE	CODE
CEILING SERVICE CAVITY INSULATION					
R0.9	35mm	600mm	2 x 6m x 570mm	6.84 m ²	09.35.570
R1.2	45mm	600mm	2 x 5m x 570mm	5.70 m ²	12.45.570
R2.4	90mm	600mm	10 x 1.2m x 560mm	6.72 m ²	24.90.560
TRUSS ROOF INSULATION					
R3.6	180mm	900mm	10 x 1.2m x 435mm	5.22 m ²	36.180.435
R4.0	190mm	900mm	10 x 1.2m x 435mm	5.22 m ²	40.190.435
TRUSS ROOF DOUBLE LAYER INSULATION					
R5.2 (R2.6 + R2.6)	290mm	900mm	12 x 1.2m x 435mm	3.13 m ²	26.145.435
R6.4 (R3.2 + R3.2)	330mm	900mm	10 x 1.2m x 435mm	2.61 m ²	32.165.435
R7.2 (R3.6 + R3.6)	360mm	900mm	10 x 1.2m x 435mm	2.61 m ²	36.180.435
R8.0 (R4.0 + R4.0)	380mm	900mm	10 x 1.2m x 435mm	2.61 m ²	40.190.435



0800 485 262 | sales@terralana.co.nz | terralana.co.nz

TIMBER I-BEAM FILLET WOOL INSULATION



TERRA LANA

PRODUCT DATA

The natural benefits of Terra Lana wool for optimal insulation of timber I-Beam systems

APPLICATIONS

- hyJOIST rafters/joists
- Lumberworx rafters/joists

FEATURES

- The only specific solution available for timber I-Beams
- Maximises thermal performance of timber I-Beams
- Custom made to fit all timber I-Beam sizes
- Easy to install, manufactured to friction fit
- Environmentally responsible product
- Naturally safe to handle & healthy in the home
- 100% recyclable (by Terra Lana)

COMPLIANCE

- BRANZ APPRAISED. Appraisal 682 [2022]
- DECLARE RED LIST FREE. Certified toxin free
- GREENGUARD. Indoor air quality test approved
- HOMESTAR/GREENSTAR. Credits available
- EPD. (in process for mid 2024 completion)
- QUALITY ASSURANCE. 50 year warranty
- H1 COMPLIANT. Designed to meet/exceed

SPEC ASSIST – Contact: spec@terralana.co.nz

- Masterspec
- Smart Spec
- Design Navigator
- H1 Reports & spec writing

DESCRIPTION

Timber I-Beams are often specified over standard solid timber framing to reduce thermal bridging and increase span capacity.

I-Beam's create voids that are difficult to insulate using standard insulation products. Terra Lana timber I-Beam fillets friction-fit within the voids to ensure maximum thermal performance.

Note

When specifying vapour control layers, such as Pro Clima Intello, directly beneath rafters, consider spacing rafters at 600mm centres max. This will ensure the insulation can friction fit and be stapled to the edge of the rafter, without applying excessive pressure on the vapour control layer, or falling out of the cavity.

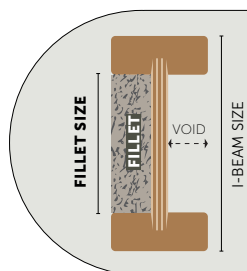
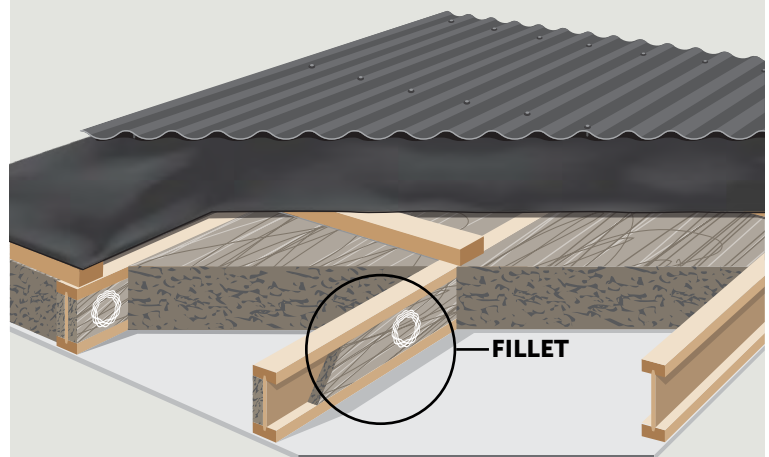

Manufacturer	I-Beam Size	Fillet Size
hyJOIST	200mm	120mm
hyJOIST	240mm	160mm
hyJOIST*	300mm	220mm
Lumberworx*	200mm	140mm
Lumberworx*	240mm	180mm
Lumberworx*	300mm	240mm

SPECIFICATIONS

R-VALUE	BATTEN	JOIST SIZE	SIZE IN BALE	M ² PER BALE	CODE
R0.9	35mm	200mm hyJOIST	8 x 6m x 120mm	48 lm/bale	09.35.120F
R0.9	35mm	240mm hyJOIST	7 x 6m x 160mm	42 lm/bale	09.35.160F

* Other product fillets made to order—specify by fillet size, as per table above



0800 485 262 | sales@terralana.co.nz | terralana.co.nz

EXTERIOR WALL WOOL INSULATION

PRODUCT DATA



TERRA LANA

The natural benefits of Terra Lana Wool designed for optimal exterior wall insulation

APPLICATIONS

- External stud walls (& ceilings where applicable)
- New and retrofit
- Residential and commercial buildings

FEATURES

- Designed to not slump or lose loft
- Superior insulative performance
- 100% recyclable (by Terra Lana)
- Easy to install, manufactured to fit
- Environmentally responsible product
- Naturally safe to handle & healthy in the home
- Manages moisture, maintaining thermal performance
- Excellent acoustic barrier qualities

DESCRIPTION

Terra Lana Wool Wall Insulation is designed with rigidity to friction fit within exterior wall cavities and not slump or degrade over the life of the building.

COMPLIANCE

- BRANZ APPRAISED. Appraisal 682 [2022]
- DECLARE RED LIST FREE. Certified toxin free
- GREENGUARD. Indoor air quality test approved
- HOMESTAR/GREENSTAR. Credits available
- EPD. (in process for mid 2024 completion)
- QUALITY ASSURANCE. 50 year warranty
- H1 COMPLIANT. Designed to meet/exceed

SPEC ASSIST – Contact: spec@terralana.co.nz

- Masterspec
- Smart Spec
- Design Navigator
- H1 Reports & spec writing



SPECIFICATIONS

R-VALUE	THICKNESS	CENTRES	BALE CONTAINS	M ² PER BALE	CODE
WALL SERVICE CAVITY					
R1.2	45mm	600mm	2 x 5m x 570mm	5.70 m ²	12.45.570
90MM WALL					
R2.4	90mm	400mm	10 x 1.2m x 360mm	4.32 m ²	24.90.360
R2.4	90mm	600mm	10 x 1.2m x 560mm	6.72 m ²	24.90.560
140MM WALL					
R3.2	140mm	400mm	10 x 1.2m x 360mm	4.32 m ²	32.140.360
R3.2	140mm	600mm	10 x 1.2m x 560mm	6.72 m ²	32.140.560
R3.6	140mm	400mm	10 x 1.2m x 360mm	4.32 m ²	36.140.360
R3.6	140mm	600mm	8 x 1.2m x 560mm	5.38 m ²	36.140.560



0800 485 262 | sales@terralana.co.nz | terralana.co.nz

SERVICE CAVITY WOOL INSULATION

PRODUCT DATA



The natural benefits of Terra Lana Wool Insulation designed to fill service cavities

APPLICATIONS

- All ceiling and wall service cavities
- New and retrofit
- Residential and commercial buildings

FEATURES

- Designed to not slump or lose loft
- Superior insulative performance
- Easy to install, manufactured to fit
- Environmentally responsible product
- Naturally safe to handle & healthy in the home
- Excellent acoustic barrier qualities

DESCRIPTION

Terra Lana service cavity insulation is designed to fill service cavity spaces adding R-Value to the thermal envelope, while still allowing the passage of wiring and plumbing services.

COMPLIANCE

- BRANZ APPRAISED. Appraisal 682 [2022]
- DECLARE RED LIST FREE. Certified toxin free
- GREENGUARD. Indoor air quality test approved
- HOMESTAR/GREENSTAR. Credits available
- EPD (in process for mid 2024 completion)
- QUALITY ASSURANCE. 50 year warranty

SPEC ASSIST

- Masterspec
- Smart Spec
- Design Navigator
- H1 Reports & spec writing

Contact: spec@terralana.co.nz

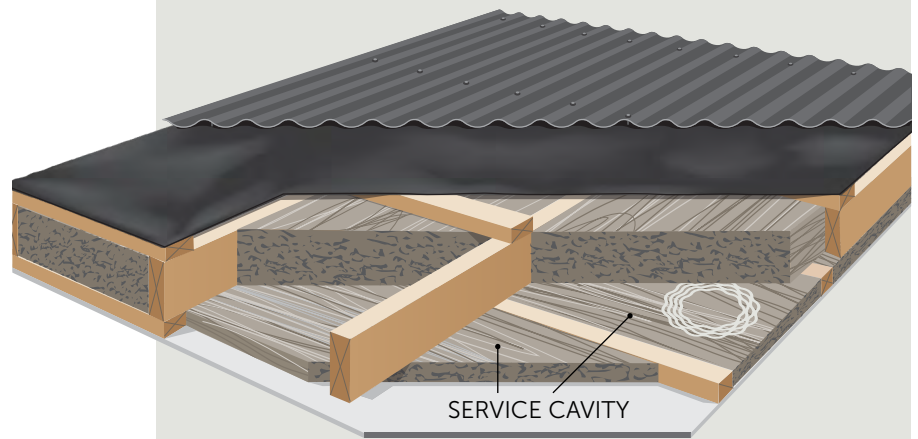

SPECIFICATIONS

R-VALUE	THICKNESS	CENTRES	DENSITY	M ² PER BALE	CODE
CEILING SERVICE CAVITY INSULATION					
R0.9	35mm	600mm	2 x 6m x 570mm	6.84 m ²	09.35.570
R1.2	45mm	600mm	2 x 5m x 570mm	5.70 m ²	12.45.570
R2.4	90mm	600mm	10 x 1.2m x 560mm	6.72 m ²	24.90.560
WALL SERVICE CAVITY INSULATION					
R1.2	45mm	600mm	2 x 5m x 570mm	5.70 m ²	12.45.570



0800 485 262 | sales@terralana.co.nz | terralana.co.nz

NEW BUILD DROP IN FLOOR WOOL INSULATION



PRODUCT DATA

The natural benefits of Terra Lana Wool insulation designed for new suspended floors

APPLICATIONS

- New lined and unlined timber suspended floors
- Retrofit, installed from above
- Non-enclosed or enclosed perimeter foundation floors
- Residential and commercial buildings

FEATURES

- Designed to not slump or lose loft
- Superior insulative performance
- Easy to install, manufactured to fit
- Environmentally responsible product
- Naturally safe to handle & healthy in the home
- Proprietary installation system
- Excellent acoustic barrier qualities

DESCRIPTION

Designed to be installed from above prior to sheet flooring, held by friction fit and Terra Lana's proprietary cradle-strap fastening system.

Terra Lana Drop In Floor Insulation is dense, semi-rigid and highly resistant to slumping, creating a wind-proof layer that fills the underfloor voids leaving no gaps.

The wool component provides optimal thermal insulation, while also transmitting moisture away from the building and remaining effective even in damp underfloor conditions.

Terra Lana is locally manufactured from predominantly natural and recycled materials and is safe and easy to handle, providing an overall product solution to meet modern environmental compliance demands.

COMPLIANCE

- BRANZ APPRAISED. Appraisal 682 [2022]
- DECLARE RED LIST FREE. Certified toxin free
- GREENGUARD. Indoor air quality test approved
- HOMESTAR/GREENSTAR. Credits available
- EPD (in process for mid 2024 completion)
- QUALITY ASSURANCE. 50 year warranty

SPEC ASSIST

- Masterspec
- Smart Spec
- Design Navigator
- H1 Reports & spec writing

Contact: spec@terralana.co.nz

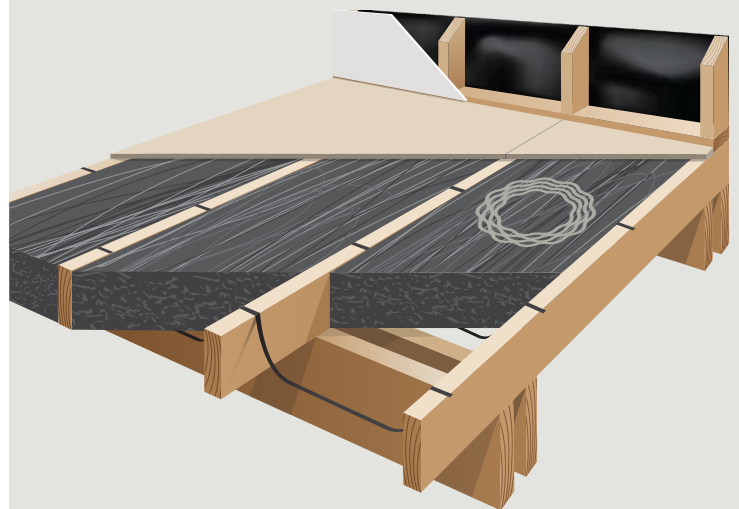

SPECIFICATIONS

R-VALUE	THICKNESS	CENTRES	BALE CONTAINS	M ² PER BALE	CODE
NEW BUILD DROP IN UNDERFLOOR – Install from above with propriety fastening system, prior to sheet flooring					
R2.7	110mm	400mm	8 x 1.2m x 365mm	3.50 m ²	DIF.110.365
R3.2	140mm	400mm	8 x 1.2m x 365mm	3.50 m ²	DIF.140.365



0800 485 262 | sales@terralana.co.nz | terralana.co.nz

RETROFIT UNDERFLOOR WOOL INSULATION



TERRA LANA

PRODUCT DATA

The superior natural benefits of Terra Lana Wool insulation designed for underfloors

APPLICATIONS

- Suspended floors, installed from the underside where there is a minimum 350mm clearance between the bearer and ground.
- Retrofit under existing floors only
- Residential and commercial buildings

FEATURES

- Designed to not slump or lose loft
- Superior insulative performance
- 100% recyclable (by Terra Lana)
- Easy to install, manufactured to fit
- Environmentally responsible product
- Naturally safe to handle & healthy in the home
- Manages moisture, maintaining thermal performance
- Excellent acoustic barrier qualities

DESCRIPTION

Designed to fill existing underfloor cavities with a durable, semi-rigid, high performance wool composition that is easy to install. The rigid structure prevents sagging, air movement and heat loss through gaps. The wool component transmits moisture vapour away from the building and maintains effectiveness in humid or damp conditions.

COMPLIANCE

- BRANZ APPRAISED. Appraisal 682 [2022]
- DECLARE RED LIST FREE. Certified toxin free
- GREENGUARD. Indoor air quality test approved
- HOMESTAR/GREENSTAR. Credits available
- EPD (in process for mid 2024 completion)
- QUALITY ASSURANCE. 50 year warranty

SPEC ASSIST

- Masterspec
- Smart Spec
- Design Navigator
- H1 Reports & spec writing

Contact: spec@terralana.co.nz

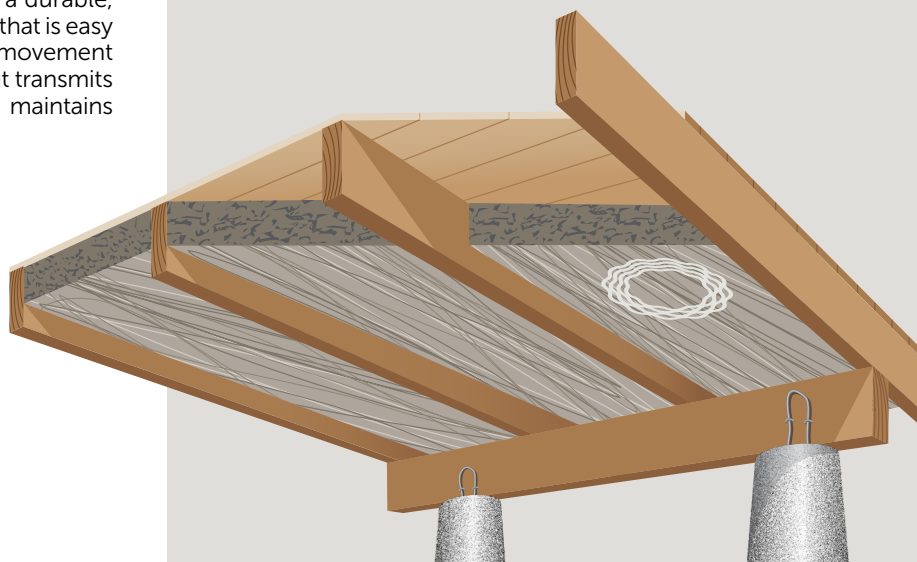

SPECIFICATIONS

R-VALUE	THICKNESS	CENTRES	BALE CONTAINS	M ² PER BALE	CODE
UNDERFLOOR INSULATION					
R2.0	115mm	450mm	2 x 5.6m x 480mm	5.38 m ²	20.115.480



0800 485 262 | sales@terralana.co.nz | terralana.co.nz

EXTERIOR WALL WOOL INSULATION

PRODUCT DATA



TERRA LANA

The natural benefits of Terra Lana Wool designed for optimal exterior wall insulation

APPLICATIONS

- External stud walls (& ceilings where applicable)
- New and retrofit
- Residential and commercial buildings

FEATURES

- Designed to not slump or lose loft
- Superior insulative performance
- 100% recyclable (by Terra Lana)
- Easy to install, manufactured to fit
- Environmentally responsible product
- Naturally safe to handle & healthy in the home
- Manages moisture, maintaining thermal performance
- Excellent acoustic barrier qualities

DESCRIPTION

Terra Lana Wool Wall Insulation is designed with rigidity to friction fit within exterior wall cavities and not slump or degrade over the life of the building.

COMPLIANCE

- BRANZ APPRAISED. Appraisal 682 [2022]
- DECLARE RED LIST FREE. Certified toxin free
- GREENGUARD. Indoor air quality test approved
- HOMESTAR/GREENSTAR. Credits available
- EPD. (in process for mid 2024 completion)
- QUALITY ASSURANCE. 50 year warranty
- H1 COMPLIANT. Designed to meet/exceed

SPEC ASSIST – Contact: spec@terralana.co.nz

- Masterspec
- Smart Spec
- Design Navigator
- H1 Reports & spec writing

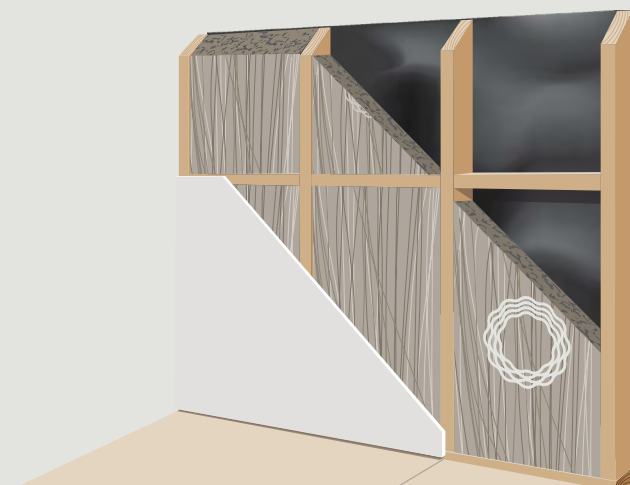

SPECIFICATIONS

R-VALUE	THICKNESS	CENTRES	BALE CONTAINS	M ² PER BALE	CODE
WALL SERVICE CAVITY					
R1.2	45mm	600mm	2 x 5m x 570mm	5.70 m ²	12.45.570
90MM WALL					
R2.4	90mm	400mm	10 x 1.2m x 360mm	4.32 m ²	24.90.360
R2.4	90mm	600mm	10 x 1.2m x 560mm	6.72 m ²	24.90.560
140MM WALL					
R3.2	140mm	400mm	10 x 1.2m x 360mm	4.32 m ²	32.140.360
R3.2	140mm	600mm	10 x 1.2m x 560mm	6.72 m ²	32.140.560
R3.6	140mm	400mm	10 x 1.2m x 360mm	4.32 m ²	36.140.360
R3.6	140mm	600mm	8 x 1.2m x 560mm	5.38 m ²	36.140.560



0800 485 262 | sales@terralana.co.nz | terralana.co.nz

CHATTERBLOCK® ACOUSTIC WOOL INSULATION



TERRA LANA

PRODUCT DATA

The benefits of Terra Lana wool's premium performance designed to block out noise

APPLICATIONS

- Inter-tenancy walls and floors **including GIB Systems** (see next page)
- Residential and commercial buildings
- Internal walls & midfloors between living areas.

FEATURES

- Designed to not slump or lose loft
- Superior insulative performance
- 100% recyclable (by Terra Lana)
- Easy to install, manufactured to fit
- Environmentally responsible product
- Naturally safe to handle & healthy in the home
- Manages moisture, maintaining thermal performance
- Excellent acoustic barrier qualities

DESCRIPTION

Terra Lana Chatterblock® leverages on wool's outstanding sound absorbing qualities. The semi-rigid construction is specifically formulated with a high density of at least 18kg/m³, giving a high flow resistance suitable for a wide range of specialised sound control.

Chatterblock® is locally manufactured from sheep wool from Canterbury farms and is safe to handle and easy to friction fit install, providing a solution that meets modern acoustic and environmental compliance standards.

COMPLIANCE

- BRANZ APPRAISED. Appraisal 682 [2022]
- DECLARE RED LIST FREE. Certified toxin free
- GREENGUARD. Indoor air quality test approved
- HOMESTAR/GREENSTAR. Credits available
- EPD (in process for mid 2024 completion)
- QUALITY ASSURANCE. 50 year warranty

SPEC ASSIST

- Masterspec
- Smart Spec
- Design Navigator
- H1 Reports & spec writing

Contact: spec@terralana.co.nz



SPECIFICATIONS

R-VALUE	THICKNESS	CENTRES	DENSITY	M ² PER BALE	CODE
CHATTERBLOCK® ACOUSTIC INSULATION – For internal walls and midfloors					
R1.4	60mm	600mm	46.7 kg/m ³	8.06 m ²	CB.60.560
R2.2	90mm	600mm	21.8 kg/m ³	8.06 m ²	CB.90.560
R3.2	140mm	600mm	18.2 kg/m ³	6.72 m ²	CB.140.560



0800 485 262 | sales@terralana.co.nz | terralana.co.nz

GIB SYSTEM SOUND TRANSMISSION CLASS PRODUCT SPECIFICATIONS

GIB SPECIFICATION	STC*	GIB SPECIFICATION	STC*
Central barrier walls Timber frame walls – with GIB Barrierline central barrier		Steel frame walls – GIB Rail and acoustic resilient mount	
		GBSA 30r	55
GBTLAB 60a	68	GBSA 60r	55
GBTLAB 60b	64	GBSA 90r	57
GBTLAB 60c	67	GBSIC 45a	55
GBTLAB 60d	61	Staggered steel stud walls	
Steel frame walls – with GIB Barrierline central barrier		GBSA 30s	55
GBSAB 60a	63	GBSA 90s	60
GBSAB 60b	67	GIB Rondo Quiet Stud	
GBSAB 60c	68	GBQSA 45	56
Staggered stud steel frame walls – with 13mm GIB Fyreline central barrier		GBQSA 60a	55
		GBQSA 90	58
GBSAB 60d	56	Floor/ceiling and suspended grid Floor/ceiling systems	
GBSAB 60e	57		
Double frame walls Double timber frame walls		GBDFA 60b	57
		GBDFA 60d	67
GBTLA 30a	56	GBDFA 60e	65
GBTLA 30b	56	GBSJA 45	55
GBTLA 60	58	GBSJA 60	56
GBTLA 90c	60	Suspended grid systems	
GBTLA 90d	64	GBSCA 45	56
Double steel frame walls		GBSCA 60a	56
GBSA 30b	54		
GBSA 60c	58		
GBSA 45	59		
GBSA 90c	60		
GBSA 90d	64		
GBTLA 90r	55		
GBTLIC 45	61		
GBTLIC 60	62		
GBTLIC 60a	57		

*Sound Transmission Class

the rating for how well a partition attenuates sound. Higher numbers denote a greater reduction of sound.

0800 485 262

spec@terralana.co.nz | terralana.co.nz

55 Francella St, Christchurch, NZ

