

Venice

VE570BN-P

Brushed Nickel Pull Out Right Angle Mixer

All dimensions in mm

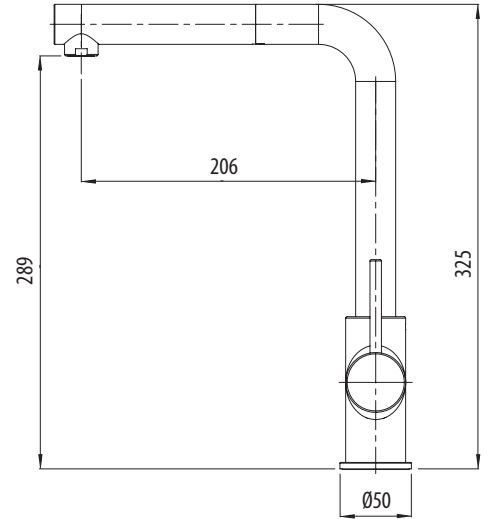

Specifications /

WELs rating	5 Stars, 5.0 L per minute
Temperature rating (min / max)	1°C - 80°C
Pressure rating (min / max)	150 kPa - 500 kPa
Finish	Brushed nickel (PVD)
Materials	Brass body (DZR low lead)
Cartridge size	35 mm
Cartridge type	Ceramic disc cartridge
Carton size	485 x 285 x 60 mm
Product weight	2.6 kg
Mixer height	325 mm
Water supply	Mains
Warranty	10 years (refer to oliveri.com.au for details)
Maintenance and care instructions	All surfaces should be cleaned with mild liquid detergent or soap and water. Do not use cream cleaners or citrus based cleaning products, as they are abrasive. Use of unsuitable cleaning agents may damage the surface. Any damage caused in this way will not be covered by warranty.