

Apollo

AP1412 NZ 1TH OF

1 & 3/4 Bowl Sink With Drainer

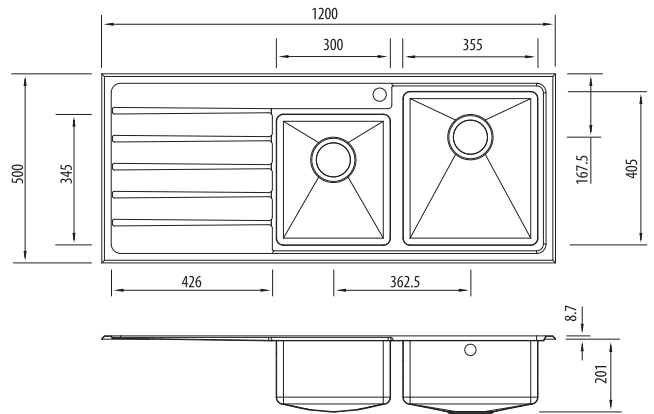

All dimensions in mm

Specifications /

Sink size	1200W x 500H mm
Bowl size	Main Bowl 355W x 405H x 200D / 29L 3/4 Bowl 300W x 345H x 200D / 21L
Construction	Fabricated with 18 mm radius corners, Softtone® and soundproofing.
Material	304 grade, 18/10 brushed stainless steel (1.2 mm thick)
Installation	Topmount
Fixings	Topmount clips supplied
Min cabinet size	800 mm
Tap holes	1 tap hole only (suitable for additional tap holes)
Waste fittings	2 x 90 mm basket wastes included
Overflow	Included
Carton size	1255 x 575 x 270 mm
Weight	15 kg
Warranty	Lifetime manufacturer's warranty (refer to oliveri.co.nz)
Maintenance and care instructions	All surfaces should be cleaned with mild liquid detergent or soap and water. To maintain the shine on your Oliveri stainless steel sink, we recommended the use of any of the easy to obtain, non-abrasive stainless steel cleaners or metal polishes.

Included accessories /

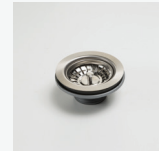

AC05
Basket Waste Kit for Overflow



AC09
Basket Waste

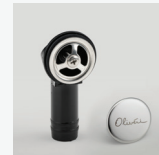

Overflow
Round with Cover