

INSTALLATION INSTRUCTIONS

COMO SHOWER MIXER | C7200

progetto
DESIGN COLLECTION

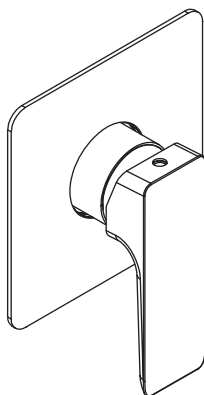

IMPORTANT!

Please read these instructions **prior** to installation

Distributed by:

Plumline

T 04 568 9898 E sales@plumline.co.nz
www.plumline.co.nz

RECOMMENDATIONS FOR INSTALLATION



ATTENTION: Failure to follow these recommendations may void the warranty. It is recommended that a qualified, licensed tradesperson install this product.

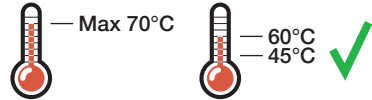

Water Pressure: 3 bar

Product performance cannot be guaranteed if pressure is less than 1 bar. Above 5 bar a pressure regulator must be installed. Failure to do so voids the product warranty.

Water Temperature: 45°-65°C

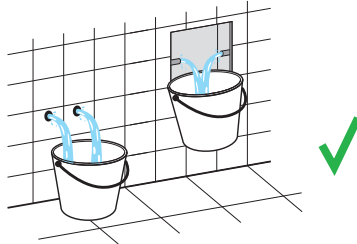

Pre-Flush

Always flush out the pipework before connecting any tapware. Failure to do so voids the product warranty.

BEFORE WALL LINING

- 1** When preparing the wall for pipework and suitable fixing points for the mixer body, ensure that the finished wall surface is within the minimum/maximum parameters shown on the protective box.
- 2** Connect the hot & cold water inlet pipes and the outlet pipe.
- 3** Fasten the mixer body to sufficient framing, ensuring that it is level.
 Pressure test the unit before wall lining.

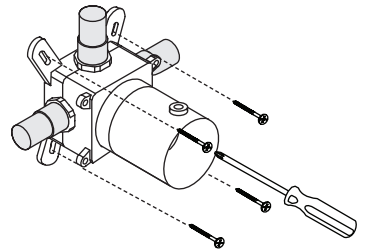
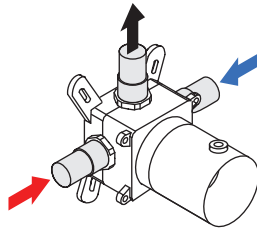
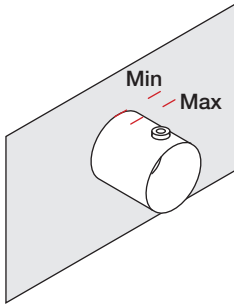

AFTER WALL LINING

- 4** Cut the protective box back to the finished wall surface.
- 5** Install the flange & handle. It is recommended to apply a small bead of silicone behind the faceplate to prevent water entering the wall cavity.
- 6** Test for performance

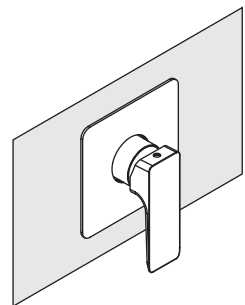
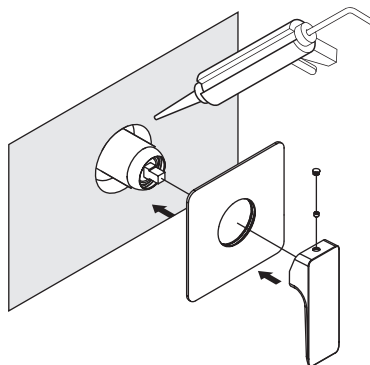
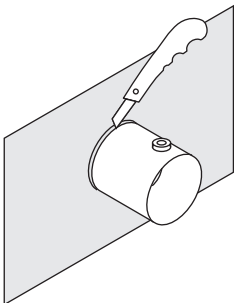

CLEANING & MAINTENANCE

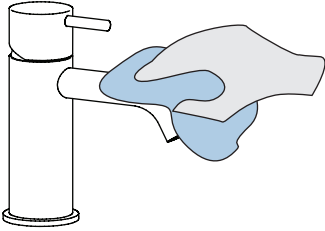

Cleaning

Clean with warm soapy water and a smooth cloth. Avoid abrasive sponges or detergents as these will damage the finish.

To preserve the finish it is recommend to apply a stainless steel oil/mineral oil on a monthly basis.

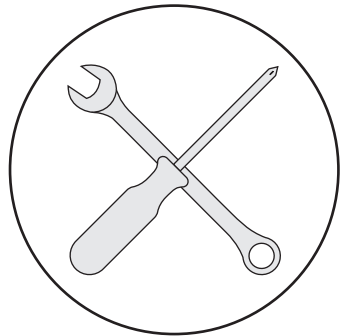
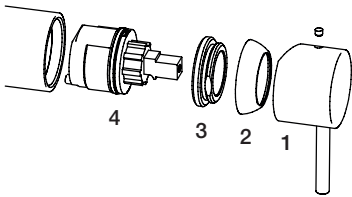

Cartridge Replacement

Before you start, turn off the water supply to the mixer.

1. Remove the handle
2. Unscrew the dome (hand tightened)
3. Unscrew the locking nut
4. Remove the cartridge

Re-assemble in reverse order

 Max tightening torque on locking nut: 10-12 Nm

Warranty Information

For full details about our warranty visit plumbline.co.nz/warranty-information