



PASLODE IMPULSE TRIMMASTER 16A ANGLED BRADDER MANUAL



IMPORTANT!



Updated maintenance
schedule instructions

ANZ Product Code B20722

TABLE OF CONTENTS

GENERAL SAFETY INSTRUCTIONS	2
TOOL SAFETY INSTRUCTIONS	3
BATTERY SAFETY & CHARGING	4
FUEL CELL SAFETY.....	5
TOOL OVERVIEW.....	6
FUEL CELL LOADING PROCEDURE	7
CORRECT TOOL OPERATING PROCEDURES.....	8
PREPARING AND USE OF TOOL	9
TROUBLESHOOTING	10
TOOL MAINTENANCE	11
TOOL SPECIFICATIONS	12
SCHEMATICS	13

GENERAL SAFETY INSTRUCTIONS

Congratulations on the purchase of your new Paslode Cordless TrimMaster 16A Angled Bradder.

The Impulse system consists of: tool, fuel cell, battery, charger and fasteners. In the interests of operator and system safety, the tool, fasteners and the fuel cells referred to in the Paslode documents, must be considered as one single, complete safety system.

WARNINGS



DO NOT ATTEMPT TO OPERATE THIS TOOL UNTIL YOU HAVE READ AND UNDERSTAND ALL SAFETY PRECAUTIONS AND MANUAL INSTRUCTIONS.



The Paslode Cordless TrimMaster 16A Angled Bradder is an internal combustion device. It produces hot exhaust gases that may ignite flammable materials. This tool must not be used in a combustible environment or in the presence of combustible materials, such as flammable chemicals, adhesives, gasoline, or solvents.



Failure to follow all safety precautions and instructions may result in a permanent loss of vision, serious personal or even fatal injury, property damage and/or tool damage.

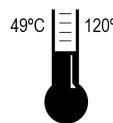

Do not expose the tool to temperatures in excess of 49°C (120°F). Fuel and/or the battery may burst, releasing flammable gas.



This tool must be operated only in a well-ventilated environment, because the tool exhausts carbon monoxide similar to a petrol/gasoline lawnmower. Exposure to carbon monoxide may cause dizziness, nausea, or unconsciousness.



ALWAYS keep the Paslode Cordless TrimMaster 16A Angled Bradder fuel cell, battery and battery charger out of the reach of children.



ALWAYS wear eye and ear safety equipment (PPE) when working with or in the vicinity of the Paslode Impulse 16A TrimMaster.



The Impulse 16A TrimMaster should not be used in the rain or where excessive moisture is present.

MAINTENANCE

Restrict Field Maintenance to the following:

- CHECKING THE ENERGY LEVEL OF THE BATTERY
- RECHARGING THE BATTERY
- CHECKING THE FUEL CELL
- REPLACING THE FUEL
- CLEANING/REPLACING THE AIR FILTER
- CLEARING A JAM
- CLEANING AND LUBRICATING THE TOOL
(SEE UPDATED INSTRUCTIONS VIA QR CODE (PG 11))



CAUTION

Never attempt any maintenance of a Paslode Impulse tool without first removing the fasteners, fuel cell and battery. Maintenance should be started only after the tool is inoperative.

Operators should be capable of conducting basic maintenance on the tool. **This will not affect your tool warranty.**

FUEL CELL CHECK

Check the fuel cell. First remove the fuel cell from the tool and check the "Best Use Before" date stamped on the bottom of the cell.

CLEARING A NAIL JAM SAFELY

1. Remove the battery, fuel and fasteners.
2. Lift the Nose Plate latch to expose the Brad.
3. Clear jam, and push driver blade back up to its rest position at the top of the cylinder.
4. Close Nose Plate and reset the latch.

FUEL CELL DISPOSAL

Dispose of all empty fuel cells responsibly. Remember to dispose of these fuel cells where they will not be crushed, punctured, burned or found by children.

Refer to your local authority regulations.

TOOL SAFETY INSTRUCTIONS

SAFETY INSTRUCTION: TOOL OPERATION

1. EYE AND EAR PROTECTION.



Eye protection must meet the requirements of AS/NZS 1337:1992 and should have side shields for increased protection.

2. NEVER ASSUME THE TOOL IS EMPTY.

Never point the tool at yourself or anyone else.

3. NEVER ENGAGE IN "HORSEPLAY" WITH THE TOOL.

Careless and improper use may result in a serious accident.

4. NEVER CARRY THE TOOL WITH YOUR FINGER ON, OR DEPRESSING, THE TRIGGER.

This practice may result in an accidental discharge or a fastener.

5. NEVER OPERATE A TOOL THAT IS MALFUNCTIONING.

Repair or refer to a service agent.

6. DO NOT LOAD FASTENERS WITH THE TRIGGER OR SAFETY YOKE DEPRESSED.

A fastener may be accidentally discharged.

7. NEVER OPERATE THE TOOL WITH THE WORK CONTACT ELEMENT REMOVED OR DISABLED.

Never operate the tool if the work contact element is not working properly or sliding freely.

8. ALWAYS POINT THE TOOL AWAY FROM YOURSELF AND OTHERS WHEN CLEARING A JAM OR REMOVING FASTENERS. ALWAYS REMOVE THE FUEL CELL AND BATTERY BEFORE CHECKING THE TOOL.

9. NEVER OPERATE THE IMPULSE TRIMMASTER IF PARTS ARE LOOSE, DAMAGED OR MISSING.

10. DO NOT DRIVE FASTENERS INTO KNOTS OR ON TOP OF OTHER FASTENERS.

A fastener may ricochet and cause serious injury.

11. OPERATE THE TOOL ONLY ON THE WORKPIECE.

12. NEVER DRIVE FASTENERS INTO AREAS WITH CONCEALED HAZARDS.

Always check the area behind the work surface for electrical wiring, gas, pipes, water pipes, sewer drains or other potential hazards.

13. ALWAYS MAINTAIN SECURE AND UNOBSTRUCTED FOOTING WHEN ON LADDERS, PLATFORMS OR OTHER HIGH LOCATIONS.

14. ALLOW ONLY QUALIFIED PERSONNEL TO OPERATE THE IMPULSE TRIMMASTER.

15. PROPERLY STORE FUEL CELL.



Always store fuel cells where they will not be exposed to an open flame, sparks, in direct sunlight or temperatures above 25°C.

16. ALWAYS STORE THE TOOL WITH THE FUEL CELL AND BATTERY REMOVED.

Store the fuel cells in the case with the Impulse TrimMaster.

17. KEEP THE TOOL CLEAN AND WELL MAINTAINED.

18. KEEP YOUR HANDS CLEAR OF THE WORK AREA SURFACE.



A fastener may exit at an angle unexpectedly and cause injury.

19. OBSERVE LOCAL BATTERY AND FUEL CELL DISPOSAL REGULATIONS.

20. WHEN NOT IN USE, REMOVE THE BATTERY AND FASTENERS AND RETURN THE TOOL TO ITS CASE.

21. IT IS NOT PERMITTED TO MAKE ANY MODIFICATION TO THE TOOL, FUEL CELL OR BATTERY OTHER THAN THOSE SPECIFIED BY THE MANUFACTURER.

22. ONLY USE PASLODE SPECIFIED CONSUMABLES, BATTERIES AND FUEL CELLS. CONSUMABLES, BATTERY AND FUEL CELLS ARE A COMBINED SAFETY SYSTEM.

23. IF THE TOOL MISFIRES, ALWAYS REMOVE THE BATTERY PRIOR TO EXAMINATION OF THE TOOL. If the problem persists contact your local centre or the tool manufacturer. The tool should be regularly inspected for defective parts, loose screws (especially after cleaning), etc and any defects rectified before use. Check prior to each operation that the safety mechanism is functioning properly.

BATTERY SAFETY & CHARGING

BATTERY AND CHARGING INSTRUCTIONS

1. Plug power adapter into charger base.
2. Connect to 240v AC outlet, a green light indicates power is on.
3. Install battery, red light indicates battery is charging.

NOTE: If battery is completely discharged, the red light and the green light may alternate back and forth for up to 20 minutes. This safety feature slowly recharges the battery until it is ready to accept the full charging current. If the red and green lights continue to alternate after 20 minutes, the battery may be damaged.

4. After charging is complete, the green light will come on.

CHARGING TIMES

First charge (new battery) - 1 hour

Discharged Battery - 5 minutes to 1 hour

DO NOT:



Charge battery outdoors, in exposed wet conditions, or in temperatures below 5°C (40°F).



Allow metal objects to come in contact with battery terminals.



Puncture or attempt to open battery case or cells.



Store battery where it will be subjected to temperatures above 49°C (120°F).



Incinerate battery.



Use a defective battery charger, one that over-heats and/or smokes when plugged in.



Immerse the battery in water.



Do not short-circuit a battery.



Do not use a battery charger which heats up excessively or gives off fumes when connected - disconnect the charger immediately.

The power adapter, charger base and battery are designed to operate together as one system. Only use the 'Paslode Impulse' charger for 'Paslode Impulse' batteries.

The charging system is designed for use in covered areas. Do not expose it to rain or to excessive humidity.

Arrange the charger lead appropriately to avoid unnecessary damage. Do not use the charger if the cable or plug is damaged. Replace immediately.

To avoid electrocution, disconnect the power supply adapter before cleaning the terminals and contacts. Use a dry cloth.

BATTERY DISPOSAL

Batteries and charging systems must be recycled or taken to a designated disposal areas. (Subject to local regulations)

TRANSPORT - LI ION BATTERY & FUEL CELLS

The contained lithium-ion batteries are subject to the Dangerous Goods Legislation requirements (see UN3480 or UN3481). The user can transport the batteries by road without further requirements.

When being transported by third parties (eg: air transport or forwarding agency), special requirements on packaging and labelling must be observed. For preparation of the item being shipped, consult an expert for hazardous material if required.

Dispatch batteries only when the housing is undamaged. Tape or mask off open contacts and pack up the battery in such a manner that it cannot move around in the packaging. Please also observe possibly more detailed national regulations.

For the transport of Paslode fuel cells use UN Code UN3478.

Transport of small amounts (<30 Kg) in a private vehicle is permitted without a transport and safety sheet (Limited quantity exemption for road transport). The regulations by transport categories are:

- Road/rail: ADR- RID - UN code 3478 class 2 code 5F
- Sea: IMDG - UN code 3478 + emergency instructions sheet F-D, S-U
- Air: IATA - UN code 3478 class 2.1

Goods must be accompanied by the written safety instruction of the chapter 5-4-3 of the ADR. Transport by post is not permitted.

FUEL CELL SAFETY

FUEL CELL SAFETY



WARNING
EXPLOSION/FIRE HAZARD



Read all instructions before using or handling the fuel cell.



Keep the fuel cell away from heat, sparks and open flame. Do not smoke when handling or operating tool or fuel cell.

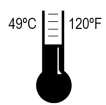

Exposure to temperatures above 49°C (120°F) may cause the fuel cell to burst, releasing flammable gas.

Sunlight can raise the inside temperature of an unventilated motor vehicle or storage container to above 60°C (140°F).



Never puncture or attempt to open the fuel cell; it is non-refillable. Never incinerate, reclaim or recycle the fuel cell. Dispose of used cell responsibly.



Never smoke while installing the fuel cell or operating the tool.



Never inhale the spray. Store fuel cell(s) in well-ventilated areas only.



Keep out of the reach of children.



Liquid gas can cause injury in the event of contact with the skin or eyes.



FUEL CELL CHECK
Paslode Impulse fuel cells are marked with a "Best Use Before" date on the bottom of the can. For maximum performance use fuel before the "Best Use Before" date.

COLD WEATHER OPERATION

Fuel combustion can be adversely affected at extreme low temperatures. Ensure that the tool battery and fuel cell are above the minimum operating temperature of 7°C (20°F) before use.

The fuel cell is an aerosol product corresponding to the 2008/47/EC regulations. It contains:

- Liquefied hydrocarbon gases (butane, propane, propylene).
- A lubricant to maximise the tool durability.

When the fuel is used there will always be some propellant left inside the cartridge. The fuel cell is always pressurized. Its contents are extremely flammable. The fuel cell is not reusable.

FUEL CELL DISPOSAL

Dispose of all empty fuel cells responsibly. Remember to dispose of these fuel cells where they will not be crushed, punctured, burned or found by children.

STORAGE

Stores and showrooms must comply with building regulations. All local instructions corresponding to fire regulations must be followed.

- Where possible, store fuel at a stable temperature in the range 7°C to 25°C. Do not expose to temperatures exceeding 49°C.
- Do not use tools that emit flames, sparks or reach high temperatures in the vicinity where fuel cells are stored.
- Do not store in designated thoroughfares, hallways or stairwells.
- Store in a well-ventilated area.
- Fuel cells must not be displayed in shop windows.
- Storage with pyrotechnic products is not permitted.

FIRST AID

- Direct contact with liquid gas may cause burns or frostbite.
- In case of inhalation remove the person to fresh air, and encourage breathing. Should the casualty become unconscious, or breathing does not quickly return to normal, summon urgent medical assistance.
- If gas gets into the eyes they should be flushed out with copious amounts of water. Skin contamination should be removed with soapy water.

If symptoms persist, seek medical assistance.

TOOL OVERVIEW



FUEL CELL LOADING PROCEDURE



ALWAYS REMOVE BATTERY, FUEL CELL AND FASTENERS WHEN SERVICING OR CLEARING A JAM.

ONLY USE PASLODE'S SPECIALLY FORMULATED FUEL, FAILURE TO DO SO MAY DAMAGE YOUR TOOL, CAUSE MISFIRES AND VOID WARRANTY.

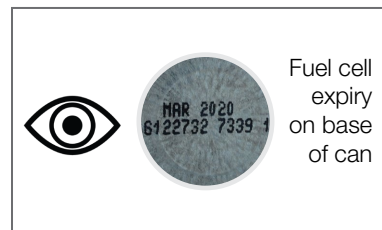

CORRECT FUEL CELL LOADING PROCEDURE



To open - Push forward, lift then back



Open fuel door assembly #33



Open fuel door fully



Raise fuel tube block assembly, will lock in up position. Part #9 & 10



Load fuel cell



Carefully align fuel adaptor and cell stem



To close - Push forward then down to lock fuel door



Note: Fuel Cell Dosing Lever must be in the down position

CORRECT TOOL OPERATING PROCEDURES



= 50 brads per strip, 2 strips per load
1.6mm Smooth Shank
Lengths 32 to 63mm
Lost Tee Head
Zinc Plated & Stainless Steel

CORRECT NAIL LOADING PROCEDURE



Insert selected brads into magazine



Make sure top of head aligns with Head supporting Brad Channel



Note: Brads are still behind follower

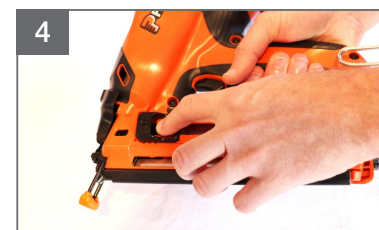

Depress follower lever #68



Pull bypass follower back past brad strip to engage brads



Allow follower to rest behind brad strip



Allow brad follower to rest behind brad strip

PREPARING AND USE OF TOOL

ALWAYS WEAR EYE AND HEARING PROTECTION

ADJUSTING THE DEPTH OF DRIVE - THUMB WHEEL ROTATION

Counter Sunk Proud

INCREASE DEPTH OF DRIVE DECREASE DEPTH OF DRIVE

CORRECT BATTERY OPERATION

ON/OFF SWITCH. Battery has 2 secure lock positions: engaged and disengaged. Press in to engage battery.

Green indicates charged battery Red indicates battery needs recharging

TOOL FIRING SEQUENCE

1000/hour max fire rate / 2-3 nails a second / -3°C to 40°C

1 Depress work contact tip

2 Actuate trigger, tool fires

3 Allow tool to recoil off work surface, work contact is released

4 With trigger released, tool will reset for next shot - sequential operation

TROUBLESHOOTING

ALWAYS REMOVE BATTERY, FUEL CELL AND FASTENERS WHEN SERVICING OR CLEARING A JAM.

FIRING THE TOOL

Tool Working Correctly Fan starts - Tool Fires OK

PROBLEM: No fan and does not fire

SOLUTION:

- Check for flat battery
- Remove and reinsert battery to reset tool
- Check for flat battery and recharge battery

PROBLEM: Fan runs but tool does not fire

SOLUTION:

- Check for empty fuel cell, flat battery, clogged filter or dirty spark plug
- Clean and oil tool
- Check driver blade returned to top of cylinder

PROBLEM: Fan runs, tool fires, no nail fed.

SOLUTION:

- Remove jammed nail
- See instruction below

TOOL MAINTENANCE



ALWAYS REMOVE BATTERY, FUEL CELL AND FASTENERS WHEN SERVICING OR CLEARING A JAM.

TIP: It may be easier to clear a nail jam by first returning the driver blade to top rest position with a small diameter punch. Then remove the nail.

CLEARING A FASTENER JAM



1 Lift nose plate cover to release nose plate assembly #60



2 Lift nose plate #60



3 Remove jammed brad



4A **Only if needed to clear jam** - remove No Mar Contact Probe #62 & 63

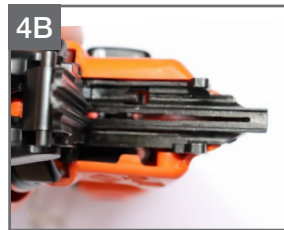

4B No Mar Probe removed, allows greater access to remove a jammed brad



4C Refit No Mar Probe

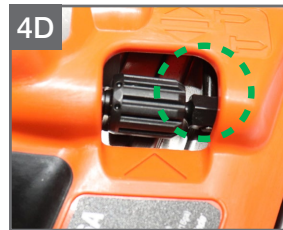

4D Align probe leg with hole in Depth of Drive adjuster



5 Verify driver piston assembly #22 is returned to top position prior to firing tool



6 Close nose plate assembly #60



7 Clip nose plate cover assembly pin over nose location studs #64



8 Close nose plate cover #60

IMPORTANT!

Please scan QR code for latest maintenance schedule. Procedures have changed since prior TrimMaster models.



TOOL SPECIFICATIONS

PASLODE IMPULSE TRIMMASTER 16A ANGLED BRADDER



MAX FIRE RATE	FIRE RATE	TEMPERATURE RANGE
hours	seconds	Celcius
1000	2 - 3 nails per second	-3 to 40 degrees C

TOOL SIZE	TOOL WEIGHT	MAGAZINE CAPACITY	NAIL SIZE	COLLATION TYPE	SHANK TYPES	TYPE OF HEAD	DURABILITY
mm	kg	Unit	mm	20° Degree			
Height: 269mm (10.6in)	1.95kg (4.3lb) without battery	100 brads x 2 strips reload	Length: 32 to 63mm Diameter: 1.6mm	Adhesive Collation	Smooth	Lost Tee Head	Zinc Plated and Stainless Steel
Length: 300mm (11.8in)	2.13kg (4.7lb) with battery						
Width: 82mm (3.5in)							

LI-ION BATTERY AND CHARGER SYSTEM



TECHNICAL DATA	PART NO	INPUT	OUTPUT	POLARITY
	Power Adapter	240V AC 50/60 Hz 30W 12VDC @ 1.8A	12V @ 1.8A	
	Battery Charger Kit B20543B		8.5VDC @ 2.0A	
	Battery B20543A		7.4 VDC Li-Ion 9.3Wh 1250mAhr 10,000 shots per charge	
	Fuel Cell Capacity 1,000 shots		Note: Use black moulded fuel cell cap only	

SCHEMATICS

SCHEMATICS cont.

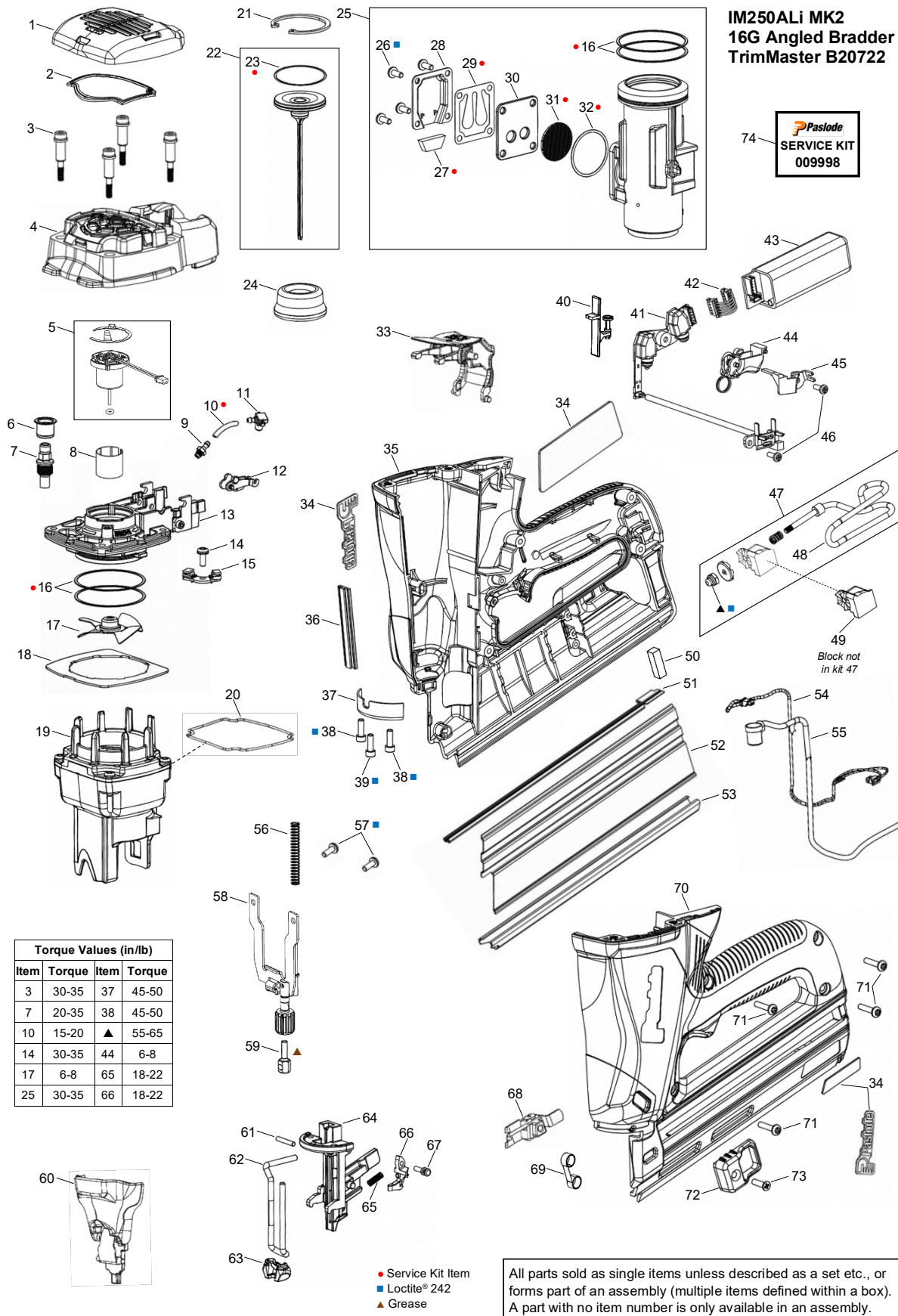

PARTS LEGEND

PASLODE IMPULSE IM250ALi MK2 16 GAUGE ANGLED BRADDER B20722

	1	916222	1	Grill
*	2	900648	1	Filter
	3	901064	4	Screw SHC 8-32 x 1-3/8
	4	916216	1	Cap
	5	901382	1	Motor Assembly, Fan
	6	916249	1	Insulator, Spark Plug
	7	916236	1	Spark Plug Assembly
	8	401356	1	Sleeve, Fan Motor
	9	904517	1	Fuel Barb
●	10	904546	1	Fuel Tube
	11	902406	1	Fuel Block
	12	904521	1	Arm, Pivot
	13	916208	1	Cylinder Head
	14	900596	1	Screw TX SEMS 8-32 x 7/16
	15	900739	1	Circuit Board Assy, Cylinder Head
* ●	16	900612	1	Ring, Cylinder Head & Sleeve
	17	900709	1	Fan Assembly
	18	900700	1	Air Dam
	19	900729	1	Combustion Chamber Assembly
*	20	900659	1	Seal, Combustion Chamber
	21	403099	1	Circlip, Piston
*	22	900728	1	Driver & Piston Assembly
* ●	23	403098	1	Ring, Piston
	24	900680	1	Bumper, Piston
	25	916288	1	Sleeve Assembly
■	26	405140	1	Screws 8-32 x 3/8 (Red)
	27	900668	1	Cover, Muffler
* ●	28	900609	1	Muffler
* ●	29	900664	1	Reed Valve
	30	900665	1	Reed Plate
* ●	31	901089	1	Disk, Pre-Filter Baffle
* ●	32	900616	1	O-Ring, Exhaust
	33	916286	1	Fuel Door Assembly
**	34	916261	1	Label Set
	35	916201	1	Handle RH
	36	916229	1	Channel, Handle Half Joint
	37	916231	1	Flange, Retaining

■	38	900708	2	Screw SHC B-32 x 1/2 (Red)
■	39	900754	1	Screw SHC B-32 x 1/2 (Yellow)
	40	900726	1	Slide Switch Assembly
	41	902439	1	Circuit Board Assembly
	42	900662	1	Wire Ribbon, ESU Power
	43	916258	1	Electronic Spark Unit (ESU)
	44	901082	1	Trigger Assembly
	45	900629	1	Bracket, Retaining
	46	404702	2	Screw TF 6-32 x 3/8
	47	918906A	1	Hook Assembly, Belt
	48	918906	1	Hook & Stop Assembly, Belt
	49	916911	1	Block
	50	902621	1	Pad, Battery
	51	916230	1	Channel, Brad
	52	916215	1	Plate, Magazine
	53	916205	1	Channel, Magazine
	54	904562	1	Wire Lead Assembly, Fan Motor
	55	904567	1	Spark Wire Lead Assembly
	56	916239	1	Spring, Yoke
■	57	900746	2	Screw 8-32 x 7/16
	58	916285	1	Yoke, Knob & Guide Assembly
▲	59	916212	1	Bolt, DoD Adjustment
	60	916284	1	Nose Plate Assembly
	61	916234	1	Pin, Nose Plate
	62	916206	1	Probe
	63	902473	1	No Mar Tip (3 Pack)
	64	916203	1	Nose
	65	900631	1	Spring, Lockout
	66	900602	1	Bar, Lockout
	67	900630	1	Pin, Lockout
	68	900808	1	Follower Assembly
	69	900627	1	Spring, Negator
	70	916202	1	Handle LH
	71	916287	4	Screw TX 8-16 x 3/4
	72	916218	1	Body, Follower
	73	916287	1	Screw, PH 8-16 x 3/4
	74	009998		AR Service Kit

- * Normal Wear Items
- ** Ensure Warning Label is affixed and legible
- Included in Service Kit
- Apply Loctite® 242 (Blue)
- ▲ Apply grease to threads
AR as required

WARNING: All parts must be periodically inspected and replaced if worn or damaged. Failure to comply can affect the tool's operation and present a safety hazard.

SAFETY INSTRUCTIONS

WEAR EYE AND HEARING PROTECTION

Always wear approved eye and hearing protection when operating tool.







Ensure others in the near vicinity use the same protective equipment.

Use eye protection when cleaning tool.





ACCESSORIES

	Paslode Impulse Battery	B20543A
	Battery Charger system	B20543B B20543C B902661
	Carry Case	
	9/64" Hex Key Maintenance tool 5/32" Hex Key Maintenance tool	900736 401331
	Impulse Tool Cleaner/Degreaser Recommended cleaner for Paslode Impulse tools	B20544L
	No Mar Tips (3 pack)	902473

For technical support contact Paslode:
Australia: 1800-PASLODE (727-563)
New Zealand: 09-477-3000

PASLODE AUSTRALIA
PO Box 914 Ingleburn 1890
Australia
www.paslode.com.au

PASLODE NEW ZEALAND
PO Box 100 303 NSMC
Auckland New Zealand
www.paslode.co.nz