



Heat Transfer Touch Screen Controller Installation Instructions

Firmware Version 3.4

Heat Transfer Touch Screen Controller

Firmware Version 3.4

Contents

Definitions/Warning/Caution	4
Installation	
Touch Screen Controller	8
Home Screen Icons	9
Button Functions.....	9
Screen Highlights.....	9
Fan and Fan Speed Setting.....	10
Setting Guide	
Auto Operation and Temperature Setting	7
Manual Operation and System Fan Speed Setting.....	7
Fan OFF Setting.....	7
Key Lock Setting.....	7
System Time-Date Settings.....	8
System Operating Settings	
Scheduler Settings.....	9
Period OFF/ON Settings.....	10
Period Schedule Log	11
Modes	
Boost.....	11
Commissioning and Testing	
Inspection Checklist.....	12
Advanced Settings	
Advanced Setting Selection	13
Advanced Settings Menu.....	14
Troubleshooting	15
Technical Specifications	15

Definitions

Before use please read and understand these definitions.

- WARNING** and/or the use of the symbol  refers to conditions where the possibility of injury, or death, exists if the procedure is not followed.
- CAUTION** CAUTION indicates the possibility of damage to the equipment, installation or premises if a procedure is not followed.
- NOTE** NOTE provides additional information intended to clarify points, procedures or instructions.

Warning

- Please read all instructions carefully before commencing installation.
- This appliance is not intended for use by persons (including children) with reduced physical, sensory or mental capabilities, or lack of experience and knowledge, unless they have been given supervision or instruction concerning use of the appliance by a person responsible for their safety.
- Children should be supervised to ensure that they do not play with the appliance.
- Precautions must be taken to avoid the backflow of gases into the room from the open flue of gas or other open-fire appliances when mounted in outside walls or soffits.
- Isolate the mains supply before making any electrical connections. This system should be installed by a registered electrician.
- A means of mains power isolation must be installed in the circuit for the purpose of safe access for any internal cleaning, recalibration or maintenance.
- All electrical, electronic and mechanical parts must be installed, and all ducting secured, before applying mains power.
- There are no isolated (safety extra low voltage) terminals incorporated. Please treat all terminals as being mains live.

Important

- If it is intended to install an air transfer system such as HeatTrans into a room where gas appliances are used for the heat source, the gas fire installation company must be consulted before undertaking installation. Section G4/ 2.2 (Mechanical Ventilation) of the NZ Building Code refers to certain safety criteria which should be considered when installing mechanical ventilation in a room where gas appliances are used. The gas heating installation company can advise on these aspects.
- The system is not designed for use with heat pumps.
- With certain models of solid fuel fires, negative pressure can cause smoke from the fire place to enter the room where the fireplace is operating.
- If you have a fireplace that uses air from the room for combustion, please ensure that make-up air is available to replace the air that is exhausted by the HeatTrans system.
- The use of a door vent can assist in circulating the air throughout the room.

Caution

- All wiring must comply with national wiring rules.
- Any changes or modifications made or attempted to this product, without the prior written approval of the manufacturer, will void any and all stated warranties.
- Take appropriate safety measures when cutting hazardous building materials.

Installation

Heat Transfer Touch Screen Controller

- Install on an inside wall at eye level in the heat source room, preferably opposite the heat source, where the air temperature can be sensed as accurately as possible and not be adversely affected by direct solar radiation or convection currents.
- **DO NOT** install in wet/damp areas (ie. laundry or bathrooms), on hot surfaces, in convection currents, exposed to direct sunlight or locations which are not generally affected by changes in the room temperature.
- **DO NOT** install near any localised heat source.
- Cut an opening in the wall for flush box and mount it.
- Run the electrical cable from the roof cavity down to the flush box.
- Wire the cable to the power module of the touch screen controller, located on the back.
- Separate the front screen of the touch screen controller from the back module. Carefully insert a flat head screwdriver into the slot and gently lever the screwdriver handle upwards.
- Mount the power module to the flush box using screws provided.
- CAUTION:** Using incorrect screws or not tightening screws sufficiently may cause damage to the product when re-assembling.
- Ensure the circuit board on the back module is centred so the connectors to the front screen can line up.
- CAUTION:** Forcing the controller back together without aligning the connectors properly may cause damage.
- Carefully attach the front screen to the back power module. Align the top edge, rock in, and listen for a click.

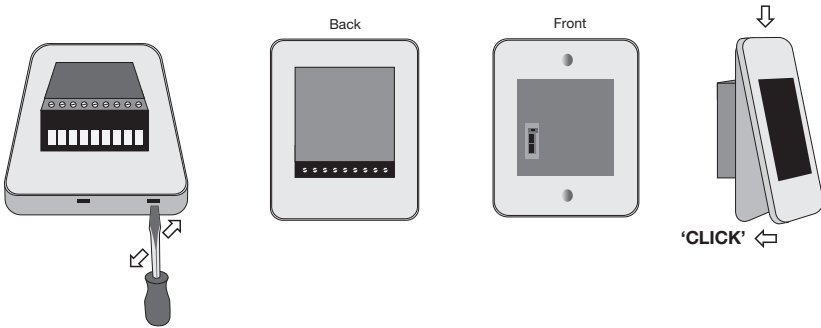

Wiring Diagrams

3 Speed

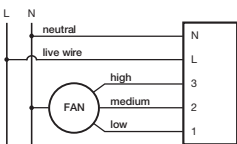

2 Speed

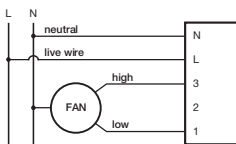

1 Speed

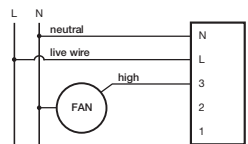



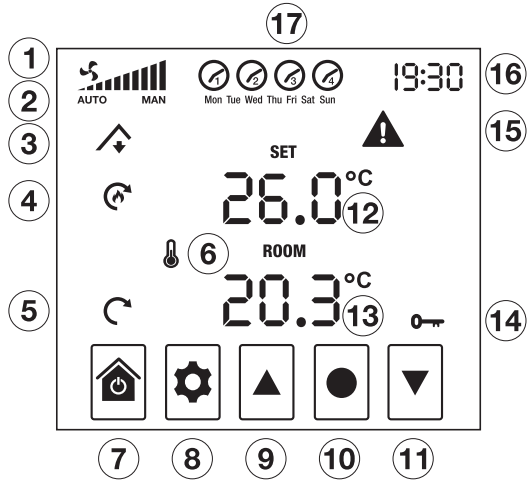

Home Screen Icons

- ① System Fan Speed
- ② Heat Transfer Mode ¹⁾
- ③ Summer Vent ON
- ④ Heat Transfer ON
- ⑤ Recycle ON
- ⑥ Temperature Sensing ON
- ⑦ Home and Power
- ⑧ Settings
- ⑨ Up
- ⑩ Select
- ⑪ Down
- ⑫ Set Temperature
- ⑬ Current Room Temperature
- ⑭ Key Lock ON
- ⑮ Alert ²⁾
- ⑯ Time ³⁾
- ⑰ Scheduler Period and Day



- 1) Heat Transfer mode selections are AUTO or MAN (manual)
- 2) When an electronic fault in the system occurs, the alert icon will appear and the applicable error code(s) will be displayed instead of the time
- 3) Time is displayed in a 24 hour clock format

Button Functions

-  Power OFF/ON or discard selections and return to Home Screen
-  From Home Screen enter setting screen or return to previous setting option
-   Scroll through setting options and change setting values
-  Save setting selection and go to next setting option

Screen Highlights

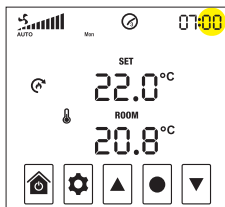

Yellow highlight indicates icon is flashing

Red highlight indicates button(s) to push





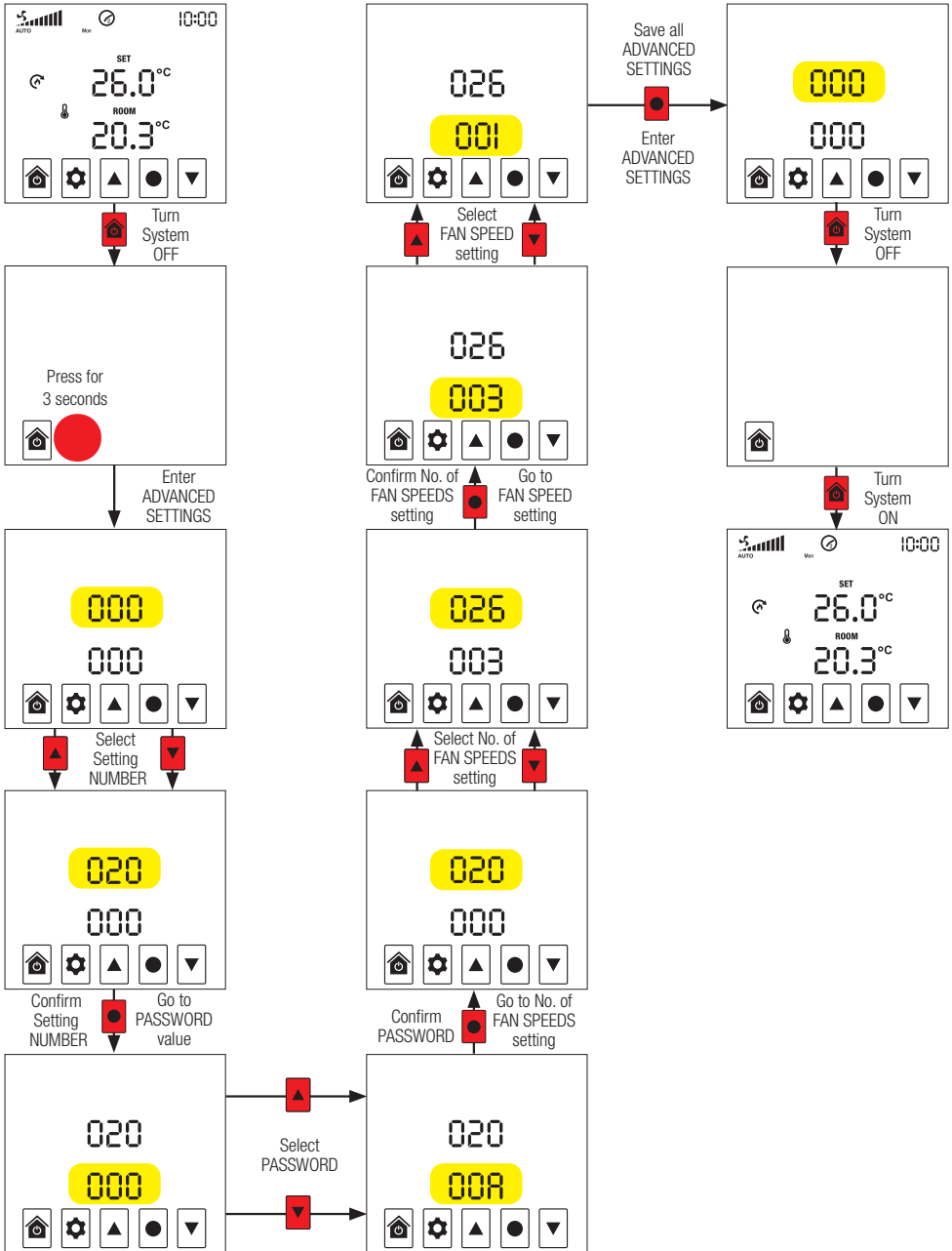

Fan and Fan Speed Setting

All HeatTrans touch screen controllers are set to the three fan speed option 003 by default and the three fan speeds available - HIGH, MEDIUM and LOW. If your fan does not have three speeds, you can follow the guide below to alter the fan speed to fan speed option 002 or fan speed option 001 and as required.



Settings Guide





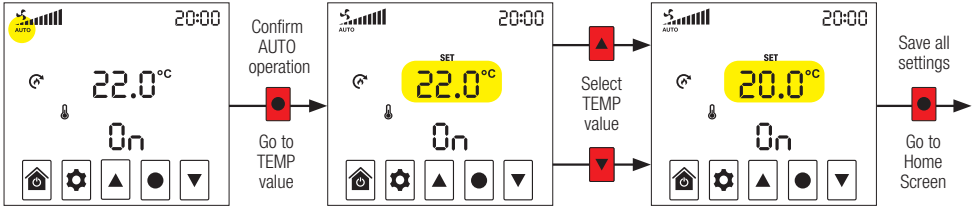

Auto Operation and Temperature (TEMP) Setting

- On the Home Screen, press SETTINGS  and then UP , or DOWN , to toggle to ON
- Press SELECT  to enter VENTILATION mode
- Press UP , or DOWN , to toggle to AUTO operation and follow the guide below to adjust the temperature setting.
- Alternately, if already in ON and on the Home Screen, press SELECT  to toggle directly to AUTO operation and follow the same guide below to adjust the temperature setting.



Fan speed will adjust automatically based on the indoor air temperature. If system is in BOOST mode, the fan will operate at the speed set for that mode.



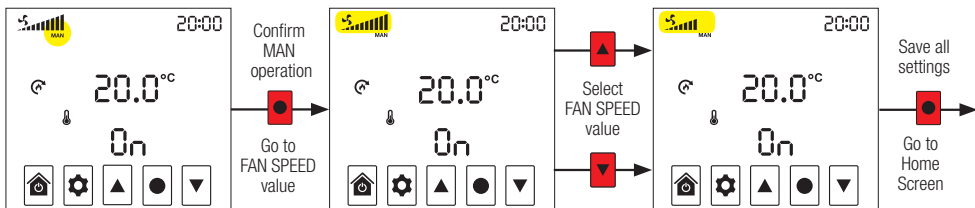

Manual (MAN) Operation and System Fan Speed Setting

- On the Home Screen, press SETTINGS  and then UP , or DOWN , to toggle to ON
- Press SELECT  to enter VENTILATION mode
- Press UP , or DOWN , to toggle to MAN operation and follow the guide below to change the system fan speed.









Fan speed will remain constant at the speed set. If system is in BOOST mode, the fan will operate at the speed set for that mode.

Fan OFF Setting

- On the Home Screen, press SETTINGS  and then UP , or DOWN , to toggle to OFF
- Press SELECT  to save the fan OFF setting.

Key Lock Setting

When Key Lock is ON, system settings cannot be changed



- Press UP  and DOWN  together for 3 seconds, until the KEY LOCK  icon is displayed, to confirm that the system is locked.
- Press UP  and DOWN  together for 3 seconds, until the KEY LOCK  icon is not displayed, to confirm that the system is unlocked.

System Time-Date Settings

System Time-Date Settings must be entered before Scheduler start times for HEAT TRANSFER can be set.

- On the Home Screen, press SETTINGS  for 3 seconds to enter Time-Date Settings and follow the guide below to complete

NOTE: Settings shown are examples only

- Press HOME  at any stage to exit and enter Scheduler Settings
- Press SETTINGS  at any stage to return to the previous screen

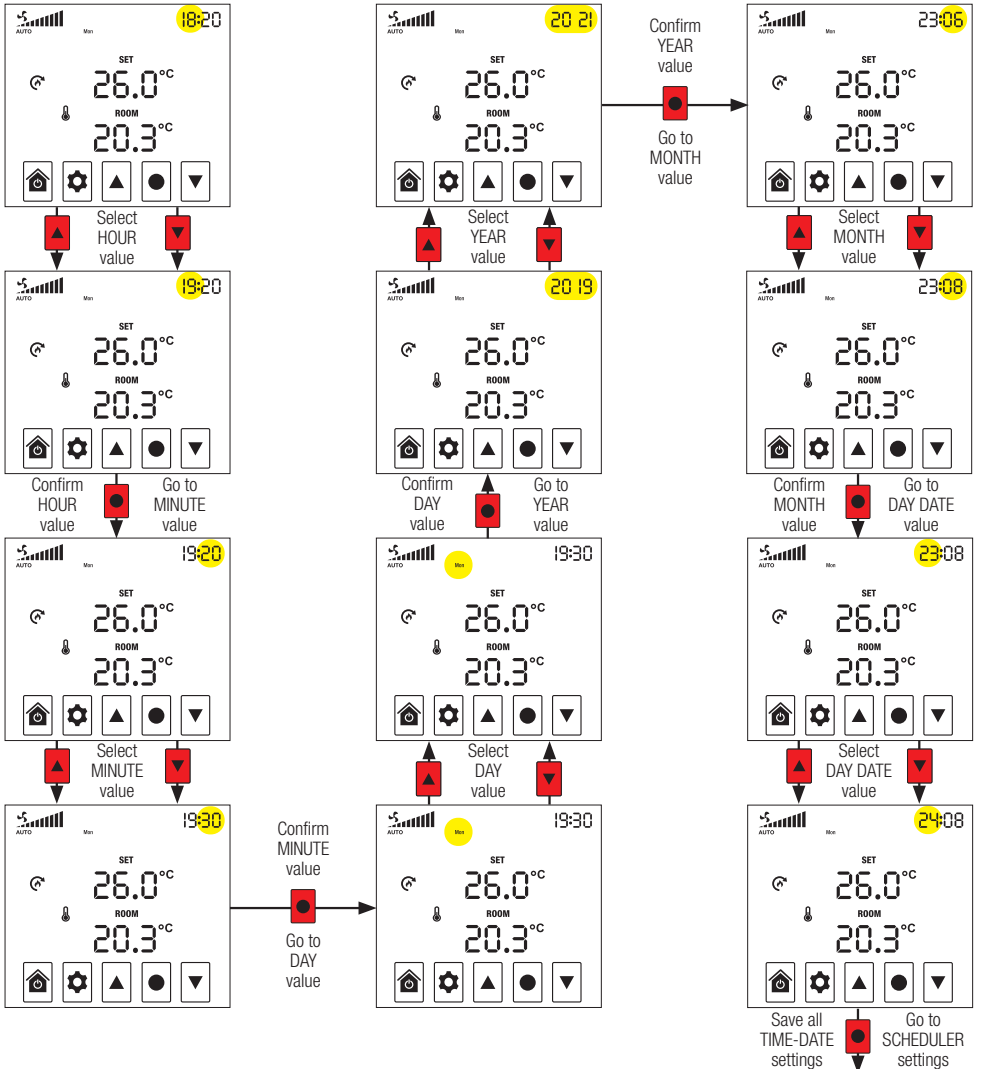



System Operating Settings





Scheduler Settings

Setting the Scheduler is only necessary if you want HEAT TRANSFER to operate for predetermined times during each of the four periods available every 24 hours. Each period of time starts with the scheduled start time for that period and ends at the start time for the next scheduled period.

- On the Home Screen, press SETTINGS  for 3 seconds then press HOME  to enter Scheduler Settings and follow the guide below to complete

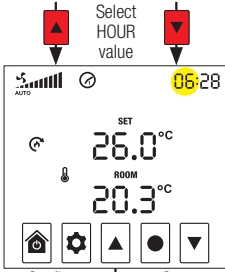
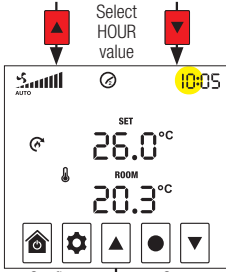
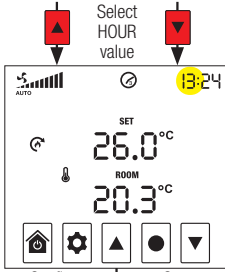
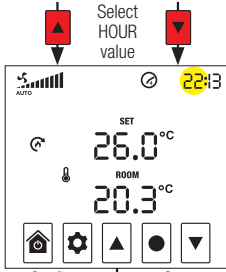
NOTE: Settings shown are examples only

- Press HOME  at any stage to exit Scheduler Settings and return to the Home Screen
- Press SETTINGS  at any stage to return to the previous screen

Period 1	Period 2	Period 3	Period 4
 <p>Select HOUR value</p> <p>06:28</p> <p>26.0°C SET ROOM 20.3°C</p> <p>Confirm HOUR value Go to MINUTE value</p>	 <p>Select HOUR value</p> <p>10:05</p> <p>26.0°C SET ROOM 20.3°C</p> <p>Confirm HOUR value Go to MINUTE value</p>	 <p>Select HOUR value</p> <p>13:24</p> <p>26.0°C SET ROOM 20.3°C</p> <p>Confirm HOUR value Go to MINUTE value</p>	 <p>Select HOUR value</p> <p>22:3</p> <p>26.0°C SET ROOM 20.3°C</p> <p>Confirm HOUR value Go to MINUTE value</p>
 <p>Select MINUTE value</p> <p>06:30</p> <p>26.0°C SET ROOM 20.3°C</p> <p>Confirm all PERIOD 1 settings Go to PERIOD 2</p>	 <p>Select MINUTE value</p> <p>10:30</p> <p>26.0°C SET ROOM 20.3°C</p> <p>Confirm all PERIOD 2 settings Go to PERIOD 3</p>	 <p>Select MINUTE value</p> <p>13:20</p> <p>26.0°C SET ROOM 20.3°C</p> <p>Confirm all PERIOD 3 settings Go to PERIOD 4</p>	 <p>Select MINUTE value</p> <p>22:00</p> <p>26.0°C SET ROOM 20.3°C</p> <p>Save all PERIOD 1-4 settings Go to Home Screen</p>

System Operating Settings



Period OFF/ON Schedule

Set HEAT TRANSFER mode to AUTO operation (see page 8).

Fan speed will adjust automatically based on the indoor air temperature.

- On the Home Screen, press SETTINGS  to enter Period OFF/ON Schedule and follow the guide below to complete the fan OFF/ON settings for each of the four periods available in a 24 hour period.

NOTE: Settings shown are examples only.

- Press HOME  at any stage to exit Period OFF/ON Schedule and return to the Home Screen
- Press SETTINGS  at any stage to return to the previous screen

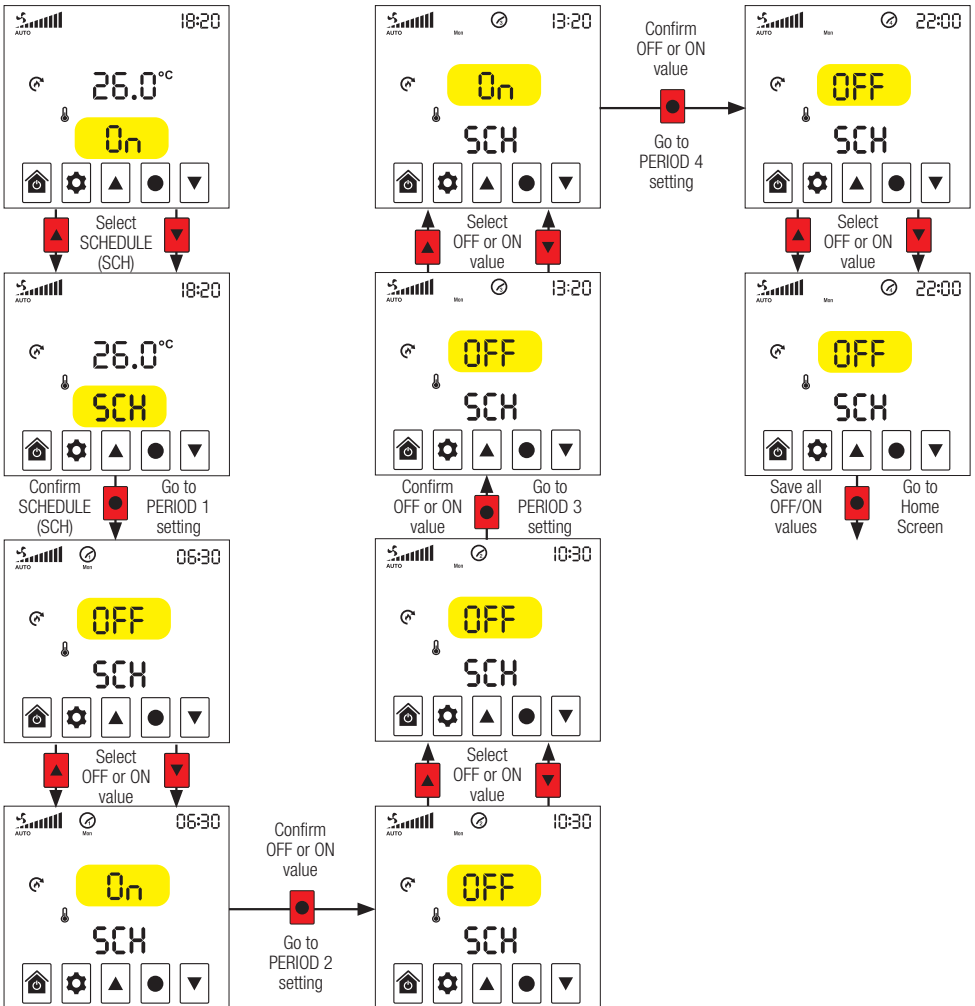

System Operating Settings

Period Schedule Log



Record your scheduled start times and OFF/ON status in the Period Schedule Log below.

Date	Period 1			Period 2			Period 3			Period 4		
	Start	OFF	ON	Start	OFF	ON	Start	OFF	ON	Start	OFF	ON

Modes

Boost

BOOST enables you to immediately override fan speed settings and boost fan speed to maximum.

- On the Home Screen, press SELECT  for 3 seconds and system's fan will boost to maximum speed.
- In BOOST mode, the time segments will become a count down to the end of the BOOST mode.
- A quick tap of SELECT  on the Home Screen will exit BOOST mode.



Commissioning and Testing

Inspection Checklist

- Controller is displaying temperatures correctly.
- Controller is configured to match the number of speeds the fan motor has.
- Fan operates on all speeds. Put fan onto high speed to continue inspection.
- There are no leaks in the ducting.
- Diffusers are open and not whistling.
- System is set to AUTO operation

Advanced Settings

Advanced Setting Selection

Advanced Settings can be changed at any time using the guide below. This guide must also be used to enter the password 000 at setting 020 before settings 021 and above can be changed.

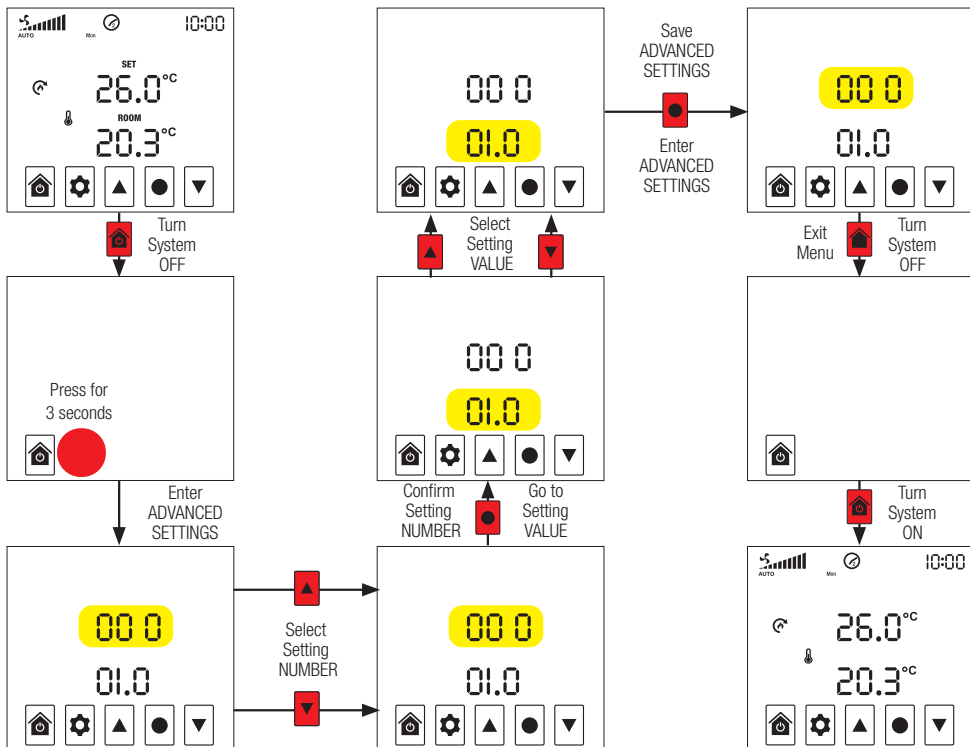

Advanced Setting Menu

SETTING	DESCRIPTION	RANGE	DEFAULT	NOTE
000	Hardware Version	N/A	3.1	
001	Firmware Version	N/A	3.4	
002	Temperature - Room	-10°C - 10°C	-2.5°C	1
003	Reserved	N/A	N/A	
004	Screen Brightness - Maximum	0 - 100%	80%	
005	Screen Brightness - Minimum	0 - 100%	20%	
006	Boost Time	0 min – 60 min	20 min	
007	Reserved	N/A	N/A	
008	Reserved	N/A	N/A	
009	Reserved	N/A	N/A	
010	Reserved	N/A	N/A	
011	Reserved	N/A	N/A	
012	Heat Transfer Speed Threshold - High	0°C - 10°C	5.0°C	
013	Heat Transfer Speed Threshold - Low	0°C - 10°C	2.0°C	
014	Reserved	N/A	N/A	
015	Reserved	N/A	N/A	
016	Reserved	N/A	N/A	
017	Reserved	N/A	N/A	
018	Reserved	N/A	N/A	
019	Restore 000 - 018 Default Settings	0 - 1	0	1 = restore
020	Enter Installer Password: 000	0 - 100	0	2
021	Summer Vent Kit Mode	0 - 1	0	1 = enabled
022	Reserved	N/A	1	Do not change
023	Reserved	N/A	N/A	
024	Reserved	N/A	N/A	
025	Fan Type	0 - 1	0	
026	Number of Fan Speeds	1 - 3	3	
027	Reserved	N/A	1	Do not change
028	Touch Activation Setting - <input type="checkbox"/> Home/Power	15 - 125	55	3
029	Touch Activation Setting - <input type="checkbox"/> Settings	15 - 125	55	3
030	Touch Activation Setting - <input type="checkbox"/> Up	15 - 125	60	3
031	Touch Activation Setting - <input type="checkbox"/> Select	15 - 125	60	3
032	Touch Activation Setting - <input type="checkbox"/> Down	15 - 125	60	3
033	EC Fan Speed - Low	0 - Medium	30%	
034	EC Fan Speed - Medium	Low - High	50%	
035	EC Fan Speed - High	Medium - Boost	70%	
036	EC Fan Speed - Boost	Boost - 100	100%	

1. If your room temperature reading is inaccurate, use this setting to calibrate.
2. Settings 021 and above are installer only settings and are only accessible after the installer password (**setting 020 = 000**) has been entered and set.
3. **CAUTION:** It is possible to render buttons inoperable and irrecoverable by adjusting the touch activation settings. Adjust at your own risk. The lower the value the more sensitive the button, the higher the value the less sensitive the button.

Troubleshooting

An ALERT  icon and error code will appear on the Home Screen when there is an electronic fault in the system. Contact Simx, 09 259 1662, for assistance.

Technical Specifications

TOUCH SCREEN CONTROLLER V3.4	
Temperature Range	5-35°C adjustable
Display Resolution	0.1°C
Operating Voltage/Frequency	220-240V AC, 50Hz
Switching Voltage	240V AC Max
Switching Current	3A max resistive load
Operating Temperature	0 to 40°C
Operating Humidity	5-90% non condensing
Live Output Isolation	Relay
Output Control	Relay / 0-10V DC
Display	3.5" digital LCD touch screen
Approval	All relevant AS/NZS standards
EMC Approval	All relevant AS/NZS standards  E6337

Specifications are subject to change without notice



Distributed by Simx Limited
PO Box 14347, Panmure, Auckland, New Zealand.
Technical Support (09) 259 1662 | e: sales@simx.co.nz | w: www.simx.co.nz

PUB1667 2011