

## UNO GOOSE NECK KITCHEN MIXER C/W POS - GUN METAL

43931.29

\$1119

ELEMENTi

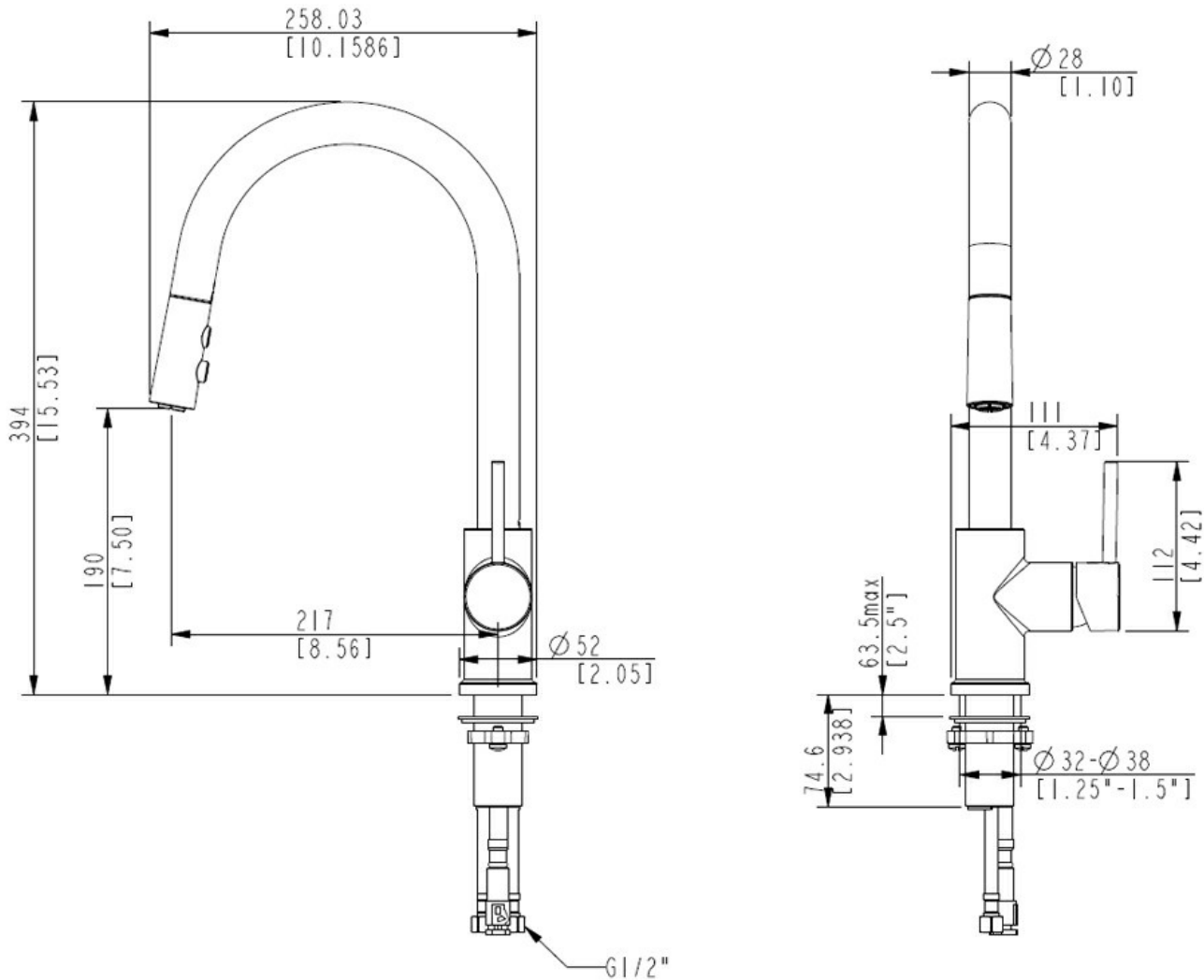

Residential/Light Commercial Use

Suitable for Residential/Light Commercial Use (Kitchens, Bathrooms and Laundries in Hotels, Motels and Retirement Villages).

5

Guarantee

5 Year Guarantee on coloured finish

10

Guarantee

10 Year Guarantee



4 Star WELS rating

More than 6.0 but not more than 7.5 litres per minute.



Mains Pressure











Suitable for Mains Pressure.



Flawless Finish

Advanced plating provides a durable surface with a long lasting finish



	<b>Effortless Control</b>	Advanced cartridge technology provides a wide operating angle and smooth operation
	<b>Smooth Flow</b>	Aerator reduces scaling while delivering a smooth even flow
	<b>Indicators</b>	Includes standard and coloured indicators.
	<b>Forward rotating handle</b>	Forward rotating handle prevents the lever hitting the splashback.
	<b>Pull Out Spray</b>	Make life easier with a pull out spray.
	<b>Swivel Spout</b>	The Swivel spout provides space, flexibility and ease of use.
	<b>Chrome Plate</b>	A base of copper is first applied followed by a layer of nickel and then finally a hard gloss coating of chromium to achieve a shiny hard wearing finish.
	<b>Blackened Oil Bronze: Black</b>	Parts are firstly nickel plated then blackened oxidation process to apply the base colour. and a transparent liquid polymer is applied achieve a mat finish and hardened surface.
	<b>Electroplated: Gun Metal</b>	Electrical current is used to dissolve components into Lacquer that then adhere to the surface.
	<b>Electroplated with PVD: Brushed Nickel</b>	Electrical current is used to dissolve components into Lacquer that then adhere to the surface. A thin metal-spray coating in the form of very thin layers is finally applied using PVD process.
	<b>Electroplated with PVD: Brushed Brass</b>	Electrical current is used to dissolve components into Lacquer that then adhere to the surface. A thin metal-spray coating in the form of very thin layers is finally applied using PVD process.

The Uno collection offers a glamorous look without being too ostentatious. After years of chrome dominating as the must-have metal, there has been a move away from the high shine, perfect finish of Chrome towards finishes like Brushed Nickel, Gun Metal, Black and Brushed Brass.