

User Instructions

D-Series
Gas Fireplace

WARNING

If the electrical cord is damaged, it must be replaced by the manufacturer, its service agent or similarly qualified persons in order to avoid a hazard.

The data label for this appliance, containing technical information and specifications, can be found adhered to the metal work under the burners.

DO NOT PLACE ARTICLES ON OR AGAINST THIS APPLIANCE.

DO NOT USE OR STORE FLAMMABLE MATERIALS NEAR THIS APPLIANCE.

DO NOT SPRAY AEROSOLS IN THE VICINITY OF THIS APPLIANCE WHILST IN OPERATION.

NEVER OPERATE THE FIRE WITH THE FRONT GLASS REMOVED.

IT IS NOT RECOMMENDED TO OPERATE THE FIRE WITH THE FASCIA PANELS REMOVED (DF and DL fires)

THE APPLIANCE MUST BE INSPECTED BEFORE USE AND SERVICED AT LEAST ANNUALLY BY AN AUTHORISED TECHNICIAN.

THIS APPLIANCE MUST BE INSTALLED IN ACCORDANCE WITH THE MANUFACTURER'S WRITTEN INSTRUCTIONS.

THIS APPLIANCE IS NOT INTENDED FOR USE BY YOUNG CHILDREN OR INFIRM PERSONS UNLESS THEY HAVE BEEN ADEQUATELY SUPERVISED BY A RESPONSIBLE PERSON TO ENSURE THAT THEY CAN USE THE APPLIANCE SAFELY.

YOUNG CHILDREN SHOULD BE SUPERVISED TO ENSURE THAT THEY DO NOT PLAY WITH THE APPLIANCE.

Manufactured by:

Escea NZ Ltd

17 Carnforth st, PO Box 5277

Dunedin, New Zealand

Email: info@escea.co.nz

Web: www.escea.co.nz

Phone: +64 3 478 8220



Distributed in Australia by:

Escea Australia PTY LTD

P.O. Box 176

Pennant Hills, Sydney,

NSW 1715

Phone: 1800 460 832

Web: www.escea.com.au

Distributed in Western
Australia by:

Escea Australia PTY LTD

P.O. Box 176

Scarborough, Perth,

WA 6019

Phone: 1800 730 140

Web: www.escea.com.au

Contents

1	Remote Control Layout	04
2	Basic Operation	05
	Initial Start / Battery Placement	05
	Adjusting the Room Temp	05
	Fan Boost	05
	Effect Only	05
3	Setting the Time	05
4	Keylock	06
5	Timer Operation	06
	Activate Timer	06
	De-activate Timer	06
6	Auxiliary On/Off Button	07
7	Over Temp Shutoff Operation	08
8	Celcius to Fahrenheit	08
9	Sound and Smell	09
	Sounds	09
	Fan	09
	Gas Control Valve	09
	Appliance Metalwork	09
	Smells	09
10	Fascia, Log, and Glass care	09
	Cleaning the Logs / Glass (DF series)	10
	Cleaning the Logs / Glass (DL series)	11
	Cleaning the Logs / Glass (DX series)	11
	Cleaning the Logs / Glass (DS Series)	12
11	Trouble shooting	13
12	Power Failure	14

1. Remote Control Layout

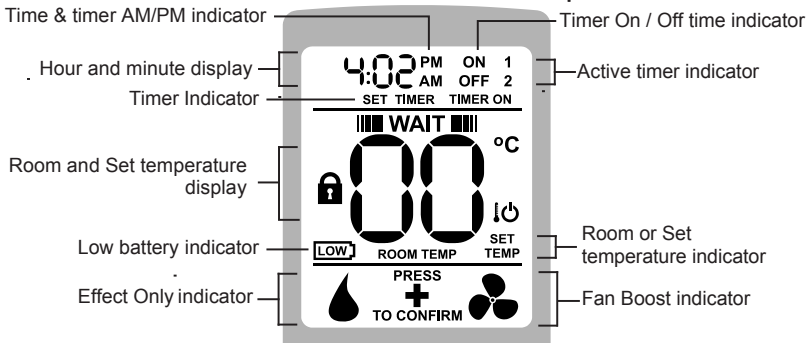
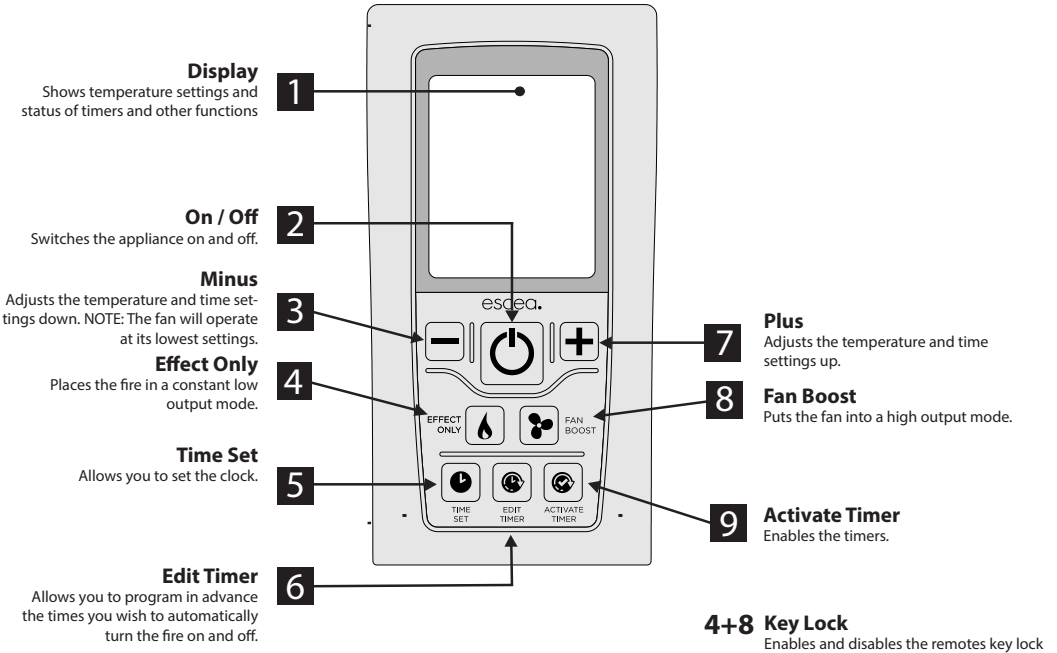

2. Basic Operation

– Initial Start / Battery Placement

Remove the battery cover on the rear of the remote. Insert the new “AA” size batteries, being careful of the polarity. You should now see on the display of the remote the time showing “0:00”. To turn the fire on, press the “POWER” (2) button once, and within a few seconds the appliance will begin its startup sequence.

NOTE: The appliance begins its startup with a fifteen to thirty second pre-ignition purge, where the combustion fan runs on its own before it tries to ignite. Between ignition attempts the remote will alternately show the remote’s “Set” temperature and a rotating segment indicator to show that the fire is in start up mode and will try to ignite again.

– Adjusting the Room Temp

To set the room temperature, press the ‘plus’ (7) or ‘minus’ (3) buttons repeatedly until the display is showing the desired temperature. The remote will then revert back to the ‘current’ room temperature after 30 seconds. The lowest flame setting will run continuously whilst the medium and high settings will operate according to the temperature set by the remote.

– Fan Boost

DL, DF, & DS-ONLY: The fire has four FAN SPEED settings. The first low fan speed will run automatically on start-up. The second and third fan speed will automatically switch on or off with the increase or decrease of the set temperature, and the fourth fan speed is an optional FAN BOOST speed, which can be accessed on your remote. Pressing the FAN BOOST button (7) will increase the fan speed to its maximum. When this mode is not on, the fire will still use fan speeds one, two, and three.

DX-Series ONLY: Pressing the FAN BOOST button (7) will make the duct fan increase speed sooner and maintain its increased flow for longer.

– Effect Only

Pressing the EFFECT ONLY button (3) will only turn on the fireplaces lowest setting. This mode is intended as an ambient effect, although some heat will still be produced, and the room air fan will continue to operate.

NOTE: The room air fan may continue to operate for a few minutes after the fire has been switched off to remove any excess heat.

Note about Batteries: If you will not be using your fire for more than 1 month, please remove the batteries.

3. Setting the Time

Press and hold the “TIME SET” button (5) for more than two seconds and this will allow you to set the hour including “AM” or “PM” using the PLUS (7) or MINUS (3) buttons.

Pressing the “TIME SET” button (5) again will allow you to set the minutes.

Press the button one more time to exit the “SET TIME” mode.

4. Keylock

Should you wish to keep the fire from being tampered with by children or to discourage people from altering the temperature you can engage a keylock function which stops the remote buttons from changing any settings. To engage the keylock simply press the “Flame Effect” and “Fan Boost” buttons (4 + 8) simultaneously until the display shows the padlock symbol.

To disengage the keylock press and hold the “Flame Effect” and “Fan Boost” buttons (4 + 8) simultaneously until the padlock symbol on the display is no longer shown; normal access to the remote functions will now be available.

NOTE: The “power” button (2) will still be able to turn the fire off. But once turned off no functions will be available until the keylock has been removed.

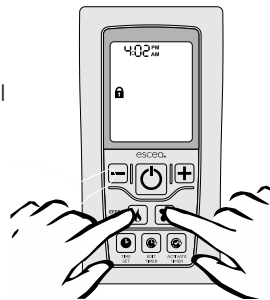

5. Timer Operation

Timers are a great way of starting the fire when you are not around to turn it on. The timers can be set so you can wake up or come home to a warm environment.

After pressing the EDIT TIMER button (5) the SET TIMER indicator and the hour figure on the clock will start flashing. On the bottom right of the display you will also see the word “ON” and the number “1”. This indicates that you are currently editing the hour that the fire will turn “ON” for timer “1”. Pressing the PLUS (7) or MINUS (3) button will change the hour.

Pressing the EDIT TIMER button (5) again will make the minute figures start flashing. You will continue to see the “ON” and the number “1”. This indicates that you are currently editing the minute that the fire will turn “ON” for timer “1”. Pressing the PLUS (7) or MINUS (3) button will change the minute.

Pressing the EDIT TIMER button (5) again will make the hour figure start flashing once again. Though now you will see the “OFF” indicator as well as the number “1”. This indicates that you are currently editing the hour that the fire will now turn “OFF” for timer “1”. Pressing the PLUS (7) or MINUS (3) button will change the hour.

Again pressing the EDIT TIMER button (5) will start the minutes flashing for you to finish editing the “OFF” time for timer 1.

Pressing the EDIT TIMER button (5) will begin the cycle all over again for timer “2”.

Note: If you do not wish to set timer ‘2’, using the plus or minus keys, navigate to ‘0:FF’ which you will find between ‘11:00’ and ‘0:00’. Press ‘Timer Select’ (5) again to exit.

– Activate Timer

Pressing the ‘ACTIVATE TIMER’ this option allows you to activate your selected times. Pressing once will activate ‘Timer 1’. Pressing twice will activate ‘Timer 2’ and by pressing again you will activate them both.

– De-activate Timer

To de-activate the timer, press “ACTIVATE TIMER” (9) until “TIMER ON” no longer shows on the screen (this will require between 1 to 3 pushes)

6. Auxiliary On/Off Button

The **DF-Series** has a manual On/Off button located on the bottom right of the fire as shown, and is accessed without removing any panels.

The **DL-Series** has a manual On/Off button located under the bottom fascia panel as shown.

The **DX-Series** has a manual On/Off button located inside the fire. To access this you will need a long thin tool (such as an allen key) and insert this through the opening on an angle as shown.

This button should be used if the wireless control becomes lost, damaged, or its batteries are flat. Pushing the “AUX On/Off” button once will start the heater and it will run at a medium heat (high for DF) output setting until the “AUX On/Off” is pushed again to shut the heater down.

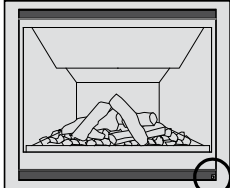

DF-Series

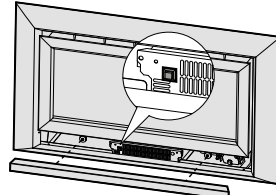

DL-Series

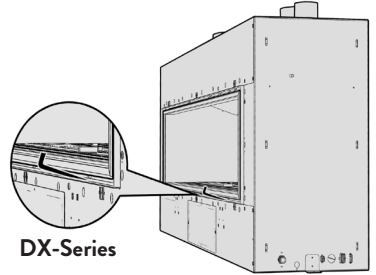

DX-Series

The auxiliary on/off button is used to turn the fireplace on without the Remote Control, and also used for “teaching” the fireplace to listen for new remote controls.

The **DS-Series** has a manual on/off button that should only be used for teaching the remote. The diagram below shows the location of this button. *Note: Ensure the appliance has cooled down before using the manual on/off button to avoid coming into contact with hot surfaces.*

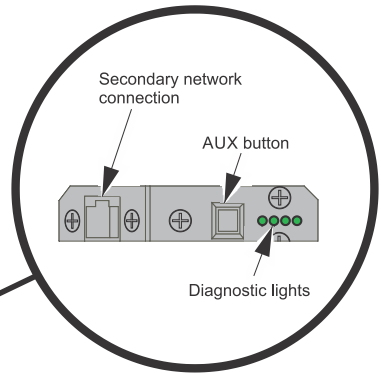
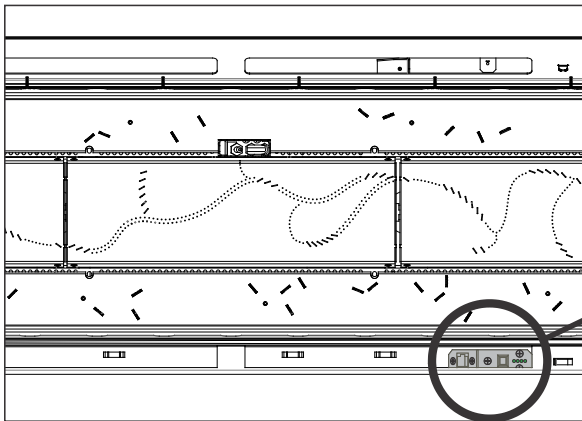

7. Over Temp Shutoff Operation

By default Escea gas fires continue running at their lowest setting when the “Room” temperature has reached the “Set” temperature. However, in some cases the output of the fire, at its lowest setting, may exceed that which is needed to keep the room at a steady temperature and the “Room” temperature may continue climbing above the “Set” temperature.

Your Escea gas fire has a setting where it will turn off the main burner once the “Room” temperature exceeds the “Set” temperature, leaving only the pilot lit. The main burner will re-light when the “Room” temperature falls back below the “Set” temperature. This is referred to as the “Overtemp Shut Off Mode”.

To enable “Overtemp Shut Off Mode”, so the fire will turn off the main burner when the “Room” temperature climbs above the “Set” temperature, you need to follow the steps below to make the adjustment to your Escea remote.

Step 1: While the remote is in its “OFF” mode with only the time showing on the display, press the MINUS (3), PLUS (7) and FAN BOOST (8) buttons simultaneously (as shown below right) until the characters “03” light up on the display. Release the buttons and the remote will count down and display “GO”. The screen will then display all characters. This will put the remote into test mode and the two big temperature digits should begin counting from 0 to 99 repeatedly.

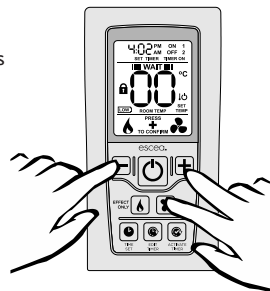

Step 2: Press the “Edit Timer” Button (5) and you will see that the temperature digits stop counting and will momentarily display “ON” to confirm the setting has been made.

Step 3: To exit the test mode press the “ON/OFF” button (2).

To turn OFF the “Over Temp Shut Off Mode”, so the burners remain lit when the “Room” temp reaches and goes above the “Set” temp, repeat step 1.

Step 4: Press the “ACTIVATE TIMER” (9) Button and you will see that the temperature digits stop counting and will momentarily display “OFF” to confirm the setting has been made.

Step 5: To exit the test mode press the ON/OFF button (2).

8. Celcius to Fahrenheit

By default Escea gas fires are set to Celcius. To change from Celcius to Fahrenheit or back, you need to follow the steps below to make the adjustment to your Escea remote.

Step 1: While the remote is in its “OFF” mode with only the time showing on the display, press the MINUS (3), PLUS (7) and FAN BOOST (8) buttons simultaneously (as shown below right) until the characters “03” light up on the display. Release the buttons and the remote will count down and display “GO”. The screen will then display all characters. This will put the remote into test mode and the two big temperature digits should begin counting from 0 to 99 repeatedly.

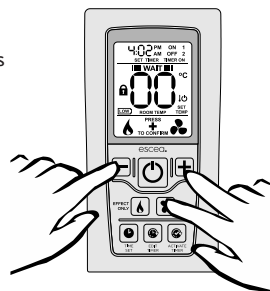

Step 2: Press the FAN BOOST button (7) and see the C or F flash with the chosen degree mode.

9. Sound and Smell

Note: Each time the fire is lit from cold the glass will fog up with condensation. This is normal and the condensation will disappear within a few minutes once the glass heats up.

– Sounds

It is possible that you will hear some sounds from your gas appliance. This is perfectly normal due to the fact that there are various types of materials used within your appliance. Listed below are some examples. These are all normal operating sounds and should not be considered as defects in your appliance.

– Fan

Escea gas appliances use electric fans to push heated air further into the room. It is not unusual for the fan to make a “whirring” sound when ON. This sound will increase or decrease in volume depending on the thermostatic settings.

– Gas Control Valve

As the gas control valves turn ON and OFF, a dull clicking sound may be audible. These sounds are part of the normal operation of the fire. When the fire is switched off after being run for a while, there may be popping and fluttering noises as the residual gas in the burner burns away. These are normal and should be no cause for concern.

– Appliance Metalwork

Different types and thicknesses of steel will expand and contract at different rates resulting in some “creaking” and “ticking” sounds being heard throughout the heating and cool down cycles.

– Smells

The first few times the unit is operated after installation, the unit may release an odour and the flames will appear orange caused by the curing of the paint, the burning off of the starch in the ceramic logs and the oils in the metal. This is a temporary curing process which will disappear with use. A deposit on the inside of the glass, caused by the starch in the logs may appear as a build up after several uses. If this film is not removed, it will bake on and may become difficult to remove. When the glass is cold, remove it (see following page) and clean the inside with a non-abrasive cleaner.

WARNING: DO NOT ATTEMPT TO CLEAN THE GLASS WHILE IT IS HOT. NEVER OPERATE THE UNIT WITH THE GLASS REMOVED.

10. Fascia, Log, and Glass care

The Fascia is the visible surround of your Escea Gas Fireplace and must be treated carefully to prevent unsightly marks from tarnishing the visual quality of the product. Some marking over time is inevitable however, so the following directions will assist you in getting the maximum enjoyment from your Escea Gas Fireplace.

NEVER RUB THE FASCIA.

The outside of an Escea Fascia must only be cleaned with a soft microfibre cloth. If heavier cleaning is required for the likes of grease or stubborn fingerprint removal we recommend the use of a dedicated stainless steel cleaner for stainless steel fascias or warm soapy water for powder coated fascias. These wipes have been tested by Escea technicians and produce very satisfying results, when used correctly. Instructions for their use follow.

For Stainless Steel Fascias:

1. Ensure that the Gas Fireplace is off and that the fascia is cold to the touch.
2. Using the gloves provided with your fascia, a stainless steel cleaner and a clean cloth, apply a small amount of cleaner to the cloth and wipe the fascia with even, straight strokes.
3. Make sure your strokes follow the direction of the grain or brush finish. Wiping across the grain can leave small scratches.
4. The cleaner may leave a very fine film over the fascia, ensure this film is distributed evenly.
5. If the film is applied too heavily and is quite visible, you can remove the excess by gently wiping dry with a microfibre cloth. Ensure your strokes still follow the direction of the grain or brush finish.
6. Ensure that no film is applied to the glass of your Escea Gas Fireplace. If applied accidentally, wipe off with an absorbent microfibre cloth.

For Powder Coated Fascias:

1. Ensure that the Gas Fireplace is off and that the fascia is cold to the touch.
2. Using the gloves provided with your fascia, gently clean the fascia with a cloth and warm soapy water.
3. Wipe off with an absorbent microfibre cloth.

– Cleaning the Logs / Glass (DF series)

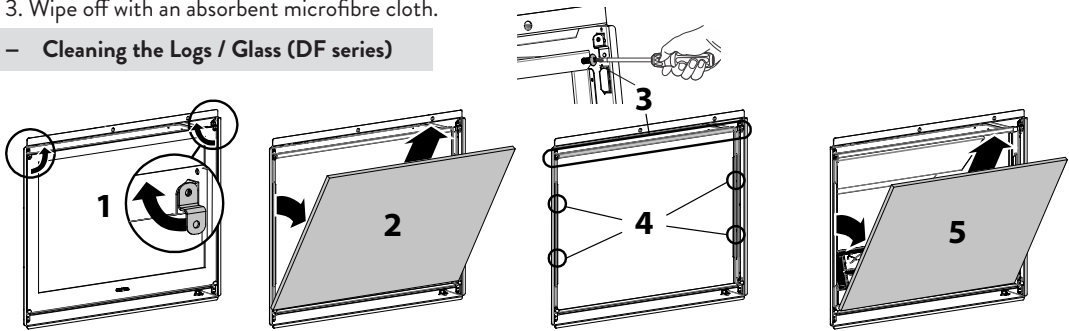

Step 1: Remove the fascia by sliding the top towards you 30-50mm and then pull the bottom away from the fireplace

Step 2: To remove the outer glass, turn the top corner brackets towards the centre of the fire (Step 1 above) until the glass has enough clearance pull forward and lift out of the bottom brackets (Step 2 above), and place the glass carefully aside.

Step 3: Remove both machine screws holding in the top bracket and slide forward (Step 3 above). Note: some fireplaces may have an aluminium extrusion instead which is not fixed with screws, that needs to be lifted up to remove.

Step 4: Unscrew the side glass brackets (Step 4 above), and lift the glass out of the bottom bracket (Step 5 above).

Step 5: Place the glass carefully aside.

Step 6: Take out fuel bed and gently brush any soot from log with a soft hearth brush. The burner tops can be vacuumed to remove any excess material.

Step 7: Clean the inside and outside of both pieces of glass with normal glass cleaning products. Use a CLEAN DRY cloth only. Stubborn marks may be cleaned with a ceramic glass cleaner.

Step 8: Replace in opposite order and test run heater.

– Cleaning the Logs / Glass (DL series)

Step 1: If using a Bevelled or Inset fascia, Remove the lower trim, which is held in place by magnets.

Step 2: Lift off the inner fascia by unscrewing the base of the inner fascia, then pulling it out and lifting it up and off.

Step 3: Unscrew the top and side glass retainers and remove them. Take care that the glass does not fall forwards at this stage.

Step 4: Lift out glass and place it carefully aside.

Step 5: Take out log set and gently brush any soot from log with a soft hearth brush. The burner tops can be vacuumed too.

Step 6: Clean the inside and outside of glass with normal glass cleaning products. Use a clean dry cloth only. Stubborn marks may be cleaned with a ceramic glass cleaner.

Step 7: Replace in opposite order and test run heater.

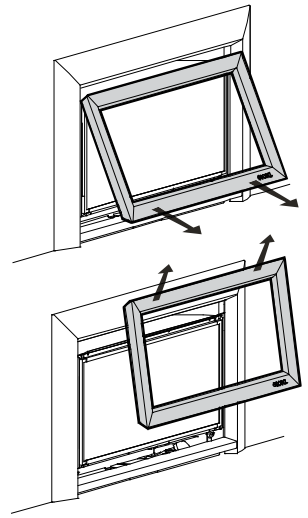

– Cleaning the Logs / Glass (DX series)

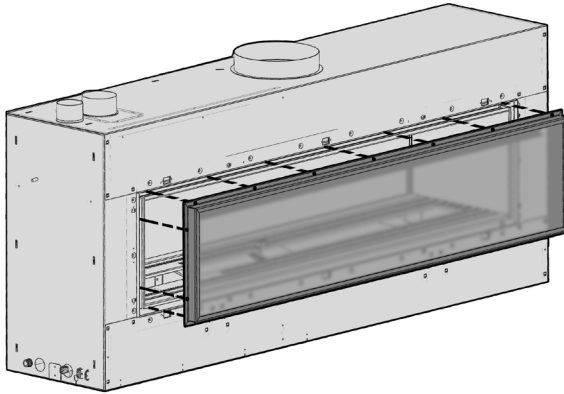

Step 1: If the fireplace has a fascia, it is recommended that you remove it first by simply pulling it towards you evenly, using protective gloves to protect the paint finish. The clips holding it in place will release.

Step 2: Unscrew all of the fasteners holding the glass in place as shown below using a 3mm allen key and carefully pull the glass and frame towards you, ensuring you hold onto the glass as well as the metal surround frame.

Step 3: Take out log set (if there is one) and gently brush any soot from log with a soft hearth brush. The burner tops can be vacuumed too.

Step 4: Clean the inside and outside of glass with normal glass cleaning products. Use a clean dry cloth only. Stubborn marks may be cleaned with a ceramic glass cleaner.

Step 5: Replace in opposite order and test run heater.

– Cleaning the Logs / Glass (DS Series)

Step 1: If the fireplace has a fascia, it is recommended that you remove it first by simply pulling it towards you evenly, using protective gloves to protect the paint finish. The clips holding it in place will release.

Step 2: Remove the glass by unscrewing the four 1/4 turn fasteners located at the top of the glass (shown in the diagram below) and remove the bracket (shown below shaded grey). Allow the glass to lean forwards and carefully lift out.

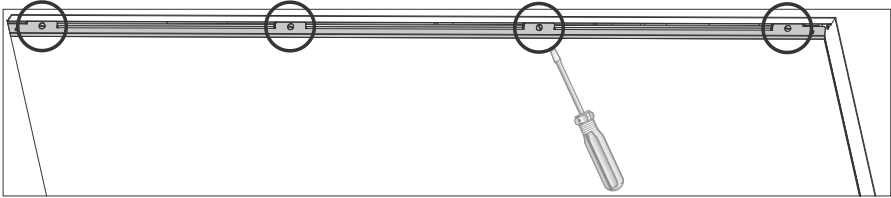

Step 3: Take out log set (if there is one) and gently brush any soot from log with a soft hearth brush. The burner tops can be vacuumed too.

Step 4: Clean the inside and outside of glass with normal glass cleaning products. Use a clean dry cloth only. Stubborn marks may be cleaned with a ceramic glass cleaner.

Step 5: Replace in opposite order and test run heater.

11. Trouble shooting

Escea gas fires communicate both to and from the fire and remote. This enables the remote to provide some basic fault finding information that is useful in diagnosing faults with your gas supply or flue.

NOTE: The remote will take a minute or two to receive and display the error from the fire. Pressing the plus or minus keys will update the remote.

Note: An error code may not signify a fault/warranty issue; depending on the error code, it may signify that the remote batteries are dead or the LPG cylinder is empty. Refer to the user manual and contact Escea if needed.

Error Code

Suggestion action



Electronics Over Temp

- Excess lint and dust build-up on the front of the controller tray.
- Possibly fascia panels installed incorrectly resulting in restricted air flow.
- Room air fans may be slowed or stalled. Remove firebox, check that fans are plugged in, cleaned, and free turning
- (DX only) check that the duct fan is not reversed and blowing “into” the fireplace instead of out from the fireplace

Note: This error has a permanent lock out and will require the unit to be reset after the initial error (turning the power to the fire off “at the wall” then on again after a few seconds).



Flame Failure or Power Flue trip

The fire has tried to light three times and failed.

- Check gas supply and check other gas appliances to see if they are affected. If you have two separate gas cylinders, switch over to the full bottle or contact your gas supplier. You may need to retry igniting the fire a few times after re-establishing gas supply.
- Check correct gas pressure to the appliance with all other appliances running
- Check the electrode placement in relation to the pilot flame. Ensure it is well enveloped in flame as per the diagram in the installation instructions. Ensure no small coals have dropped onto the ignition electrodes between the burners.
- Ensure the electrode is not contacting any metalwork including the burners and has the correct air gap.
- Check that the electrical power cable between the appliance and the power-flue wall terminal is connected and not damaged
- Check that the fan inside the powerflue wall terminal is running during startup. This fan may need servicing if it is slowed or stalled.



Appliance Over Temperature Sensor Trip

The bimetallic snap disk mounted on the spigot seal plate at the rear of the fire has tripped. The possible causes for this could include:

- Possibly fascia panels installed incorrectly resulting in restricted air flow at the top of the fire.
- Room air fans may be slowed or stalled. Remove firebox, check that fans are plugged in, cleaned, and free turning
- The gas regulator being set too high resulting in excess heat build-up.
- The inlet flue not being connected and the appliance drawing warm air from the cavity. Check flues are securely connected at both ends.



Valve Solenoid
Check Failure

The valve solenoids have failed the pre-ignition test. This is to detect a faulty valve solenoid. However, it is possible a wire has dislodged.

- Check that the connections to each solenoid are secure and in place. It may be that the connections on the ends of the wires need to be tightened a little (e.g. with a pair of pliers) to ensure a robust connection to the valve terminal.
- Disconnect and reconnect the firebox connectors ensuring they are firmly pushed into place.
- It could also be that one of the solenoids on the valve inside the fire has failed. If this is the case the valve will need to be replaced.



Remote Cannot
communicate with
fire

The remote cannot communicate with the fire. Reasons for this could include:

- The fire being turned off “at the wall” i.e. a loss of power to the fire or the remote is outside of its effective radio frequency range (too far away from the fire). Typical remote range is 1m to 12m.
- Ensure there is power to the fire by pressing the auxiliary on/off (red) button on the fire, then press the on/off button on the remote to clear the error.



Combustion Air
Flow Error

- Check whether the pressure switch is activating at startup (there is an orange indicator LED in the control tray). If not check the pressure switch electrical connection is correct.
- Check that the hoses are connected at both ends. Ensure the hoses are not kinked.
- Ensure the pressure switch is mounted vertically and the diaphragm is operational. The grey hose should be connect to the low pressure port and the translucent to the high pressure port
- Check that both flues are securely connected at both ends to the appliance and the powerflue wall terminal and that the flue is not damaged



(DX Only) Duct
Overtemp

The hot air duct temperature sensor has detected excessive heat at the duct outlet.

- Ensure that there are at least TWO air vents installed and open in the same room as the fireplace
- Ensure the duct fan is operating when the fireplace is running. If not check that the duct fan cord is plugged into the fireplace.

12. Power Failure

In the event of power failure the fire will immediately shutdown and the gas valves will automatically close. If the remote was turned off after the power cut then the fire will return to standby mode once the electrical supply is restored until its next use. If however the remote was left in the on mode then the fire will relight within a few minutes of the electrical supply being restored.