

ENVIRA[®]

BY NIAGARA

APRIL 2024 EDITION

UPDATED ON 16 APR. 2024 VERSION 03.12



Bevel Back

**TECHNICAL MANUAL
& INSTALLATION GUIDE**





0800 36 78 46 | sales@niagara.nz | www.niagara.nz
Niagara Sawmilling Company Limited



Bevel Back **TECHNICAL MANUAL**
& **INSTALLATION GUIDE**



ENVIRA[®]

BY NIAGARA

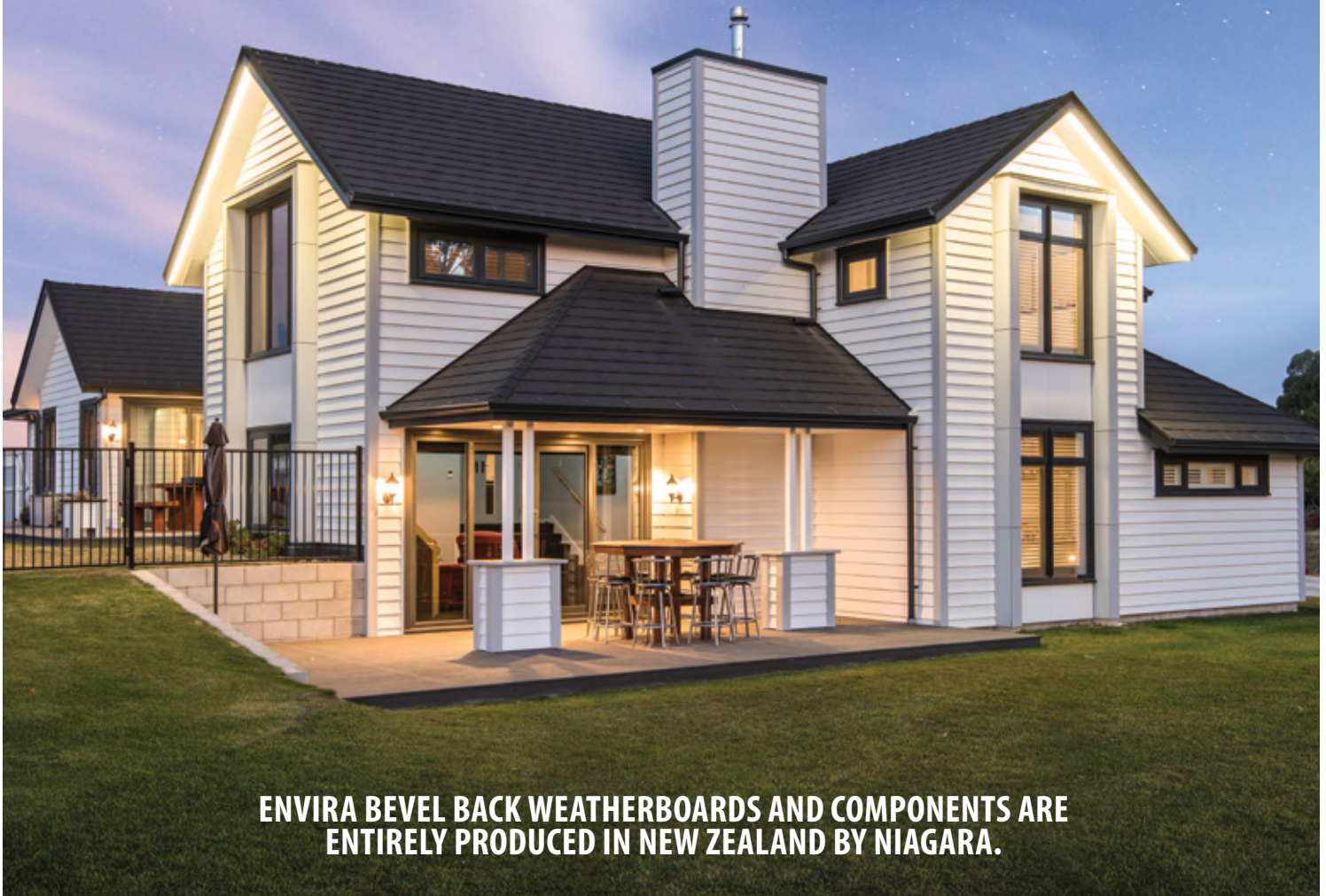

ENVIRA BEVEL BACK WEATHERBOARDS AND COMPONENTS ARE ENTIRELY PRODUCED IN NEW ZEALAND BY NIAGARA.

PRODUCT DETAILS

- Envira Weatherboard System is suitable as an Acceptable Solution E2/AS1 under the NZ Building Code.
- Kiln dried to between 10-14% moisture content.
- Treated to H3.1 using a new generation organic preservation system.
- Coated with factory applied new generation primer.



Niagara produces and distributes other quality building products.
View the full collection online: www.niagara.nz

Every effort has been made to ensure the information given in this booklet complies with existing building standards and recognised codes of practice at the current date of publication. No responsibility is accepted for any errors and omissions in this booklet or for any work or specifications based on this information.

GRADE GUIDE

Envira Weatherboard System is produced from kiln dried radiata pine in finger jointed or dressing grade.

Finger Jointed: In nominal lengths 6.1m made up of clear radiata glued and joined. Treated to H3.1 and factory primed.

Dressing Grade: A high grade board with sound tight knots and other natural characteristics. Treated to H3.1 and factory primed. In random lengths.

Solid Clears: Available on request. Generally clear on all four sides apart from minor imperfections. Treated to H3.1 and factory primed. In random lengths.

Any questions?

Freephone 0800 36 78 46
www.niagara.nz



The mark of
responsible forestry
FSC® certified products
available on request

GENERAL CONTENTS

Bevel Back components	6
Bevel Back spacing from the wall	7
Bevel Back set-out-guide	8
Section 1 General	9
1.1 Scope and general comment	9
1.2 Storage	9
1.3 Handling	9
1.4 Keep dry	9
1.5 Wall underlay	9
1.6 Flashings	9
1.7 Sealants	9
1.8 Air seals	9
1.9 Building preparation	9
1.10 Wall cladding cavities	9
Weatherboard measurement table	9
Section 2 Installation	10
2.1 Envira weatherboards fixings and fixing method	10
2.2 Joins	10
2.3 External box corner	10
2.4 Internal box corner	10
2.5 Aluminium window and door jambs	11
2.6 Aluminium window and door sills	11
2.7 Aluminium window and door heads	11
2.8 Timber window and door openings	11

Section 3 Nailing	12
3.1 Nail selection	12
3.2 Nailing schedule	12
3.3 Nailing guidelines	12
3.4 Bevel Back temporary fixing method	12
3.5 Screw Fixing Option	12

Section 4 Painting and Maintenance	13
4.1 Moisture content	13
4.2 Preparation	13
4.3 Top coat selection	13
4.4 Painting	13
4.5 Maintenance	13

Technical Drawings	14 -44
Direct fix	14 - 27
Cavity fix	28 - 44

Envira Weatherboard System warranty	45
--	-----------

BEVEL BACK DRAWING DIRECTORY

Bevel Back Direct Fix

Foundation Timber	14
Foundation Concrete	14
Door Sill	15
Door Jamb	15
Door Head	15
Window Sill	16
Window Jamb	16
Window Head	17
Soffit	17
External Corner	18
Internal Corner	18
Meter Box Head	19
Meter Box Jamb	19
Meter Box Sill	19
Pipe Penetration	20
Fascia Eaves	20
Apron	20
Parapet Cap	21
Stucco – Below	21
Stucco – Internal Corner	22
Stucco – External Corner	22
Profiled Metal – Above	23
Profiled Metal – Below	23
Profiled Metal – Abutting	24
Profiled Metal – Internal Corner	24
Profiled Metal – External Corner	25
Masonry Veneer – Below	25
Masonry Veneer – Abutting	26
Masonry Veneer – Internal Corner	26
Masonry Veneer – External Corner	27
Water Proof Deck – Above	27
Mid-Floor Junction	27

Bevel Back Cavity Fix

Foundation Timber	28
Foundation Concrete	29
Door Sill	29
Door Jamb	30
Door Head	30
Window Sill	31
Window Sill (Sill Support Bar)	31
Window Jamb	32
Window Head	32
Window Head A	33
Soffit	33
External Corner	34
External Corner Soaker	34
Internal Corner	35
Meter Box Head	35
Meter Box Jamb	36
Meter Box Sill	36
Pipe Penetration	37
Fascia Eaves	37
Apron	37
Parapet Cap	38
Stucco – Below	38
Stucco – Internal Corner	39
Stucco – External Corner	39
Profiled Metal – Above	40
Profiled Metal – Below	40
Profiled Metal – Abutting	41
Profiled Metal – Internal Corner	41
Profiled Metal – External Corner	42
Masonry Veneer – Below	42
Masonry Veneer – Abutting	43
Masonry Veneer – External Corner	43
Masonry Veneer – Internal Corner	44
Water Proof Deck – Above	44
Mid-Floor Junction	44

BEVEL BACK COMPONENTS

All H3.1 and factory primed

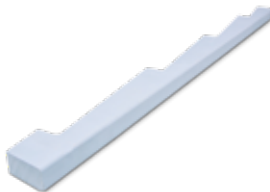
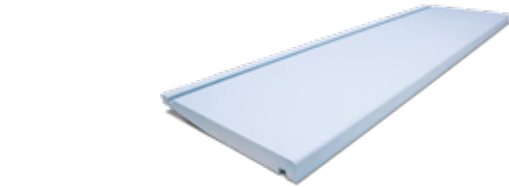

BEVEL BACK WEATHERBOARDS

Envira Bevel Back	142x18mm	Finger Jointed	6.1m
Envira Bevel Back	187x18mm	Finger Jointed	6.1m
Envira Bevel Back	230x18mm	Finger Jointed	6.1m
Envira Bevel Back	142x21mm	Dressing Grade	Random length
Envira Bevel Back	190x21mm	Dressing Grade	Random length

BOX CORNERS PREFABRICATED

Envira External	100x100mm	Finger Jointed	5.4m
Envira Internal	100x100mm	Finger Jointed	5.4m

FACING BOARDS

Envira Facing	66x18mm	Finger Jointed	5.4m
	90x18mm	Finger Jointed	5.4m
	115x18mm	Finger Jointed	5.4m
	138x18mm	Finger Jointed	5.4m
	185x18mm	Finger Jointed	5.4m
Also available in 30mm			

SCRIBERS

EnviraScribe, pre-cut	40x18mm	Finger Jointed	3.0m
	40x10mm	Finger Jointed	3.0m
	To suit 142, 187x18		
Scriber	60x18, 60x10	Finger Jointed	5.4m
	40x18, 40x10	Finger Jointed	5.4m

BEVEL BACK ACCESSORIES

Envira Sill	90x42mm	Finger Jointed	5.4m
	65x42mm	Finger Jointed	5.4m
Envira Eaves Mould	40x27mm	Finger Jointed	5.4m
	18x18mm	Finger Jointed	5.4m
Envira Tilt Fillet	25x9mm	Finger Jointed	5.4m
Envira Head Trim	82x38mm	Finger Jointed	5.4m
Envira Door Trim	50x19mm	Finger Jointed	5.4m

BATTEN

Envira Cavity Batten	44x20mm	Finger Jointed	5.4m
----------------------	---------	----------------	------

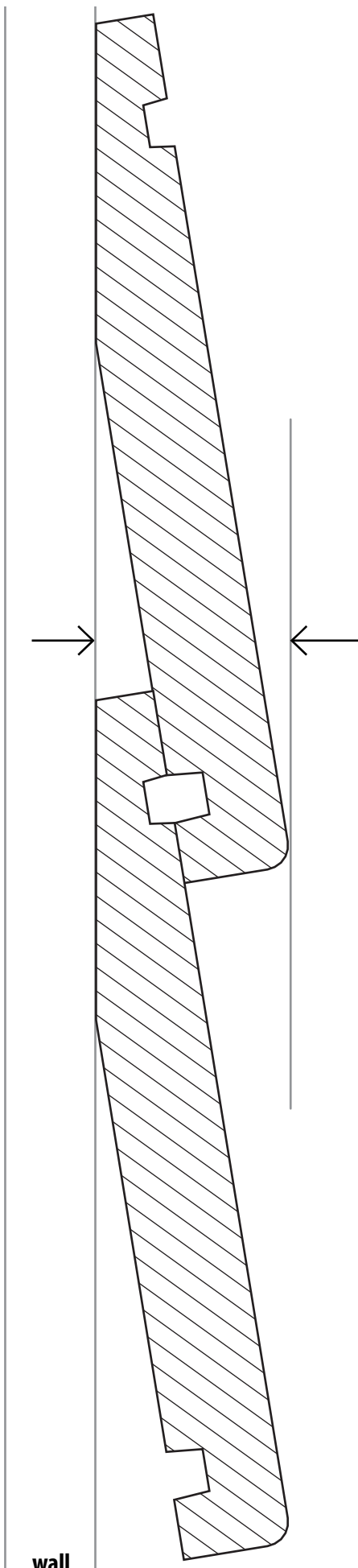

X mm

142 x 18 X = 31.8 mm

142 x 21 X = 35.7 mm

187 x 18 X = 30.7 mm

190 x 21 X = 35.4 mm

**BEVEL BACK WEATHERBOARD
SPACING FROM THE WALL**

wall

ENVIRA BEVEL BACK SET-OUT GUIDES

142 Bevel Back Weatherboard

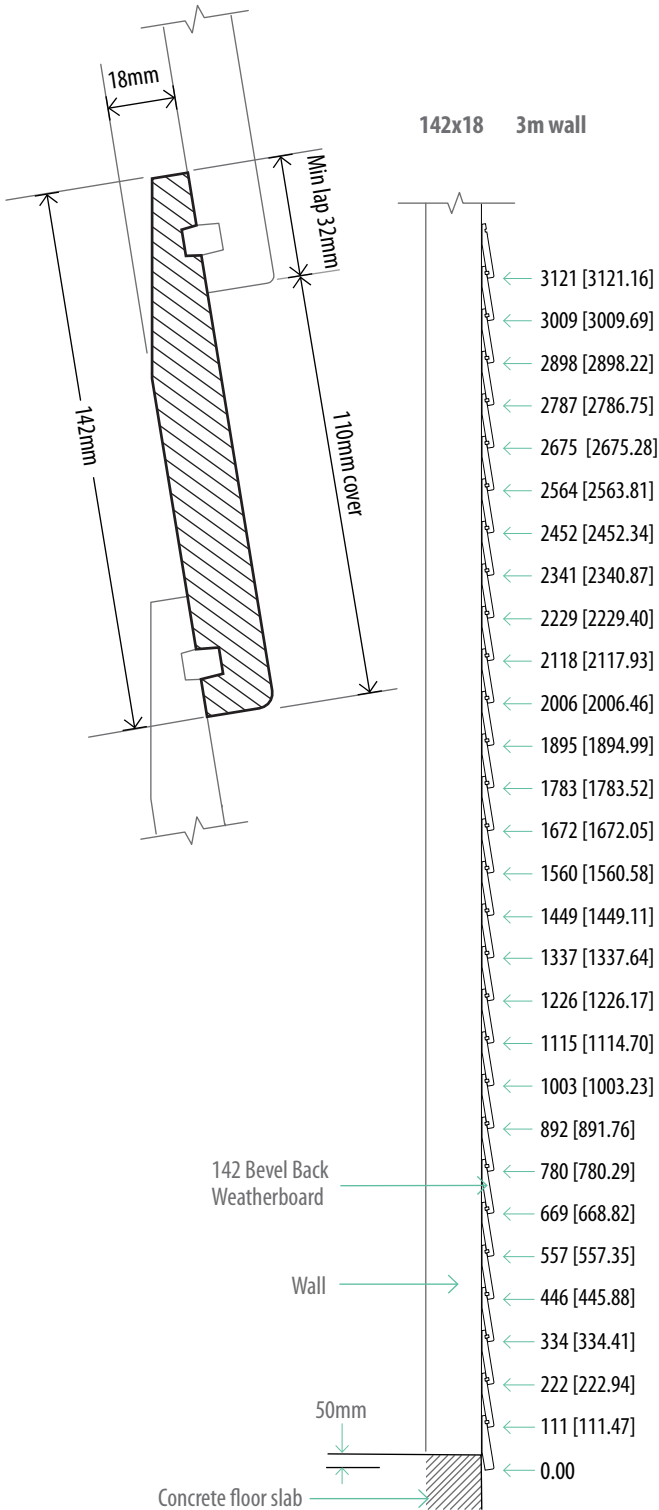

187 Bevel Back Weatherboard

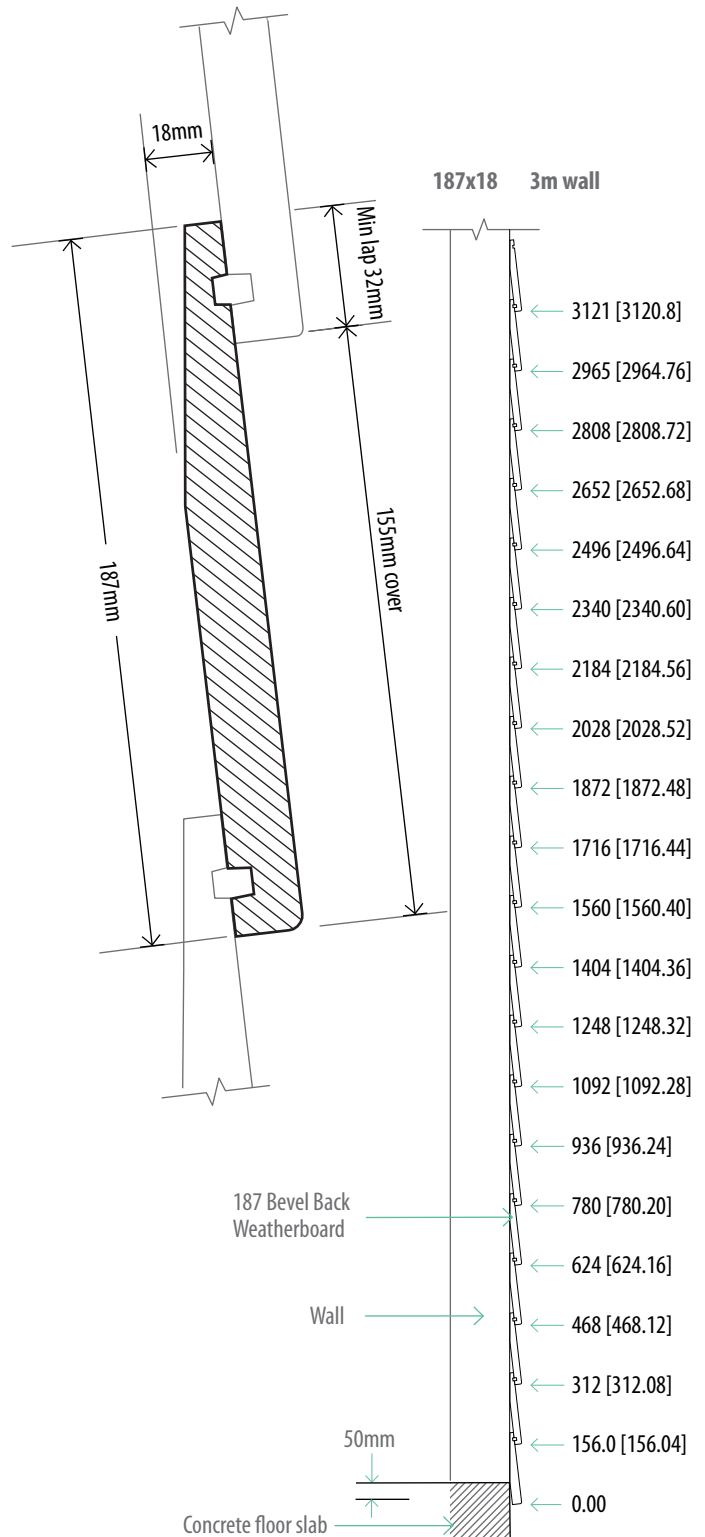

GENERAL

1.1 Scope and general comment

These instructions are specific and can be used for buildings that fall within the scope of NZS 3604:2012 Timber Framed Buildings and E2/AS1. Buildings that have Envira Bevel Back Weatherboards and have a weathertightness risk score of more than 12 as assessed in E2/AS1 section 3 will require a drained and ventilated cavity.

Niagara's Envira Weatherboard System must be fixed to framing that is dry (<20% mc), straight and stable. Flashings as shown in the installation CAD drawings must be used.

All building sites are different and while these instructions are detailed, only those details that apply to your specific building site should be used.

When used in combination, timber framed windows and timber cladding are not covered by E2/AS1 and application for an alternative solution to New Zealand Building Code Clause E2 must be made to the Building Consent Authority.

1.2 Storage

Correct storage of Envira Weatherboard System components prior to installation is critical. Store as follow:

- in a dry well ventilated area
- on a flat surface supported every meter along the length of the product
- clear of the ground by at least 150mm
- protected from the elements including direct sunlight and rain
- if rising damp is likely, place a moisture barrier under the stack
- use inside storage where available

1.3 Handling

Unload Envira Weatherboard System products carefully from truck by hand or use a mechanical lifting device. Never drag boards across the ground. To avoid bending, always carry individual boards on their edge. During handling (cutting, installation etc.) care should be taken to avoid damaging the surface of the board.

1.4 Keep dry

Envira Weatherboard System products are made from kiln dried timber. Timber is hygroscopic and it will absorb moisture in a damp environment and release it in a dry environment. Primers will not stop moisture uptake. If timber absorbs moisture prior to installation, some dimensional swelling may occur, this will disappear when the timber returns to its original moisture content.

If product shows signs of dimensional swelling, allow time for it to dry and return to the manufactured dimensions before installation.

1.5 Wall underlay

Use only underlays that meet the requirements of E2/AS1 Table 23. Underlays are a secondary protective barrier against weathering and must be installed in accordance with E2/AS1 section 9.1.7.

Envira bevel back weatherboard measurement table

Size	Profile	Grade	Cover	Lap	Length	Lm/m ²
142 x 18	Bevel Back	Finger Jointed	110mm	32mm	6.1m	9.10
187 x 18	Bevel Back	Finger Jointed	155mm	32mm	6.1m	6.45
230 x 18	Bevel Back	Finger Jointed	198mm	32mm	6.1m	5.05
142 x 21	Bevel Back	Dressing Grade	110mm	32mm	Random	9.10
190 x 21	Bevel Back	Dressing Grade	158mm	32mm	Random	6.33

1.6 Flashings

Refer to NZS 3604 section 4 and E2/AS1 Table 20 for durability requirements and E2/AS1 section 9 for flashing design and fabrication details.

As recommended in E2/AS1, window and door suppliers are responsible for head flashings. A layer of kraft paper is required between the flashing and timber framing where the timber has been treated with a copper-based treatment. Check the flashing manufacturer's recommendations in all cases.

1.7 Sealants

All sealants must be suitable for exterior use and while they will assist with providing weathertightness at laps and joints they must not be relied on to provide total protection.

1.8 Air seals

Air seals are a barrier that prevent air flowing through the cladding or circulating within the cavity, from entering the building. Air seals are required where a hole or penetration through the external cladding occurs - windows, doors, pipes, meter boxes etc. See E2/AS1 for complete building air seal requirements.

A backing rod of a suitable diameter must be installed in the gap between the window/door reveal, meter box or pipe and the opening frame prior to applying the sealant. Take care not to over fill the space with sealant.

Backing rods and sealants must be used in accordance with the manufacturer's instructions. See E2/AS1 for details.

1.9 Building preparation

NZS 3604 sets out the requirements that timber framing must meet including sizing, spacings, straightness (Table 2.1) and moisture content. All framing must meet these requirements before installation of Envira Weatherboard System can begin.

Ensure all openings are framed out with the correct clearance between the trimmed opening and the window/door/meter box frame.

1.10 Wall cladding cavities

If the weathertightness risk score is higher than 12 a drained and ventilated cavity will be required between the underlay and Envira bevel back weatherboards.

If a cavity is required, structurally fix Envira treated cavity battens to the framing in accordance with BRANZ Bulletin issue 673, (June 2022). Cavity construction, including flashing and vermin proofing, must be in accordance with the requirements as set out in E2/AS1 and NZS 4229.

INSTALLATION

2.1 Envira bevel back weatherboards fixings and fixing method

Using an Envira tilt fillet, position and fix the bottom Envira weatherboard ensuring there is a minimum 50mm overlap below the bottom plate or bearer. The tilt fillet will provide the correct layback angle for the bottom board.

Correct positioning of each successive board (32mm lap) is critical to ensure finishing scribes fit correctly. **Use an Envira precut scriber as a storey rod to assist in this process. (Keep this rod dry at all times to maintain its correct dimensions).**

Each Envira weatherboard will be fixed with one nail at every batten or stud, starting in the middle of the board and working to the ends. Single point nailing will allow the board to expand and contract as Equilibrium Moisture Content change occurs. Fixings are to be located 40mm above the lower edge of the board penetrating 35mm into the framing or structural batten.

Use 75 x 3.15 JH hot-dipped galvanised or annular grooved stainless steel nails for fixing either directly into framing or structural battens.

Re-prime the cut ends with two coats of a premium quality timber primer, allowing to dry between coats.

Hand nailing is recommended as nail guns can cause damage to the surface of the board. If a nail gun is used a non-marking attachment should be used to avoid damage to the board surface. Fill with an exterior grade wood filler immediately after nailing. Avoid using nail guns as they can damage the surface of the board. Pre-drill nail holes at all joints and within 50mm of ends.

The top board may have to be cut to suit soffit.

For screwing option refer 3.5

2.2 Joins

Avoid joining Envira weatherboards whenever possible but if joining is unavoidable, only use 45 degree scarf joints directly over studs or Envira structural battens.

Face the overlapping board away from the prevailing weather direction using one fixing through the overlapping board (pre-drill the hole). Re-prime the cut ends with two coats of a premium quality timber primer, allowing to dry between coats.

Nails should be hand driven and punched below the surface to allow for filling.

Prime then fill with an exterior grade wood filler immediately after nailing.

2.3 External box corner

Using 50 x 2.5mm JH hot-dipped galvanised or annular grooved stainless steel nails, fix the Envira two piece prefabricated external box corner over the Envira bevel back weatherboards. Use two nails at each fixing point. There must be a minimum 50mm cover on both faces of the corner.

Fixings must be located 35-40mm above the lower edge of the overlapping board on every fourth board for 142mm wide weather boards and every third board for 187mm wide weatherboards. For nails near the ends of the corner boards pre-drill the nail holes.

Fit a precut EnviraScribe over the weatherboards against the corner boards. Pre-drill holes and using 50 x 2.0mm (40 x 18 scriber) or 30 x 2.0mm (40 x 10 scriber) JH hot-dipped galvanised or annular grooved stainless steel nails, fix the scriber firmly against the box corner. Nail at 450mm centres.

Re-prime the cut ends with two coats of a premium quality timber primer, allowing to dry between coats.

Nails must be hand driven and punched below the surface to allow for filling. Prime then fill with an exterior grade wood filler immediately after nailing.

2.4 Internal box corner

Internal corners, direct or cavity, must have a flashing behind the cladding that provides a minimum 50mm cover to both faces of the corner. Refer to E2/AS1 for full details. Using 50 x 2.5mm JH hot-dipped galvanised or annular grooved stainless steel nails, fix the Envira two piece prefabricated internal box corner over the Envira bevel back weatherboards. Use two nails at each fixing point. The Envira internal box corner provides 100mm cover on both faces of the corner.

Fixings must be located 35-40mm above the lower edge of the overlapping board on every fourth board for 142mm wide Envira bevel back weatherboards and every third board for 187mm wide weatherboards.

Use two nails at each fixing point. For nails near the ends of the corner boards pre drill the nail holes.

Fit a precut EnviraScribe over the weatherboards. Pre-drill holes and using 50 x 2.0mm (40 x 18) or 30 x 2.0mm (40 x 10) JH hot-dipped galvanised or annular grooved stainless steel nails, fix the scriber firmly against the box corner. Nail at 450mm centres.

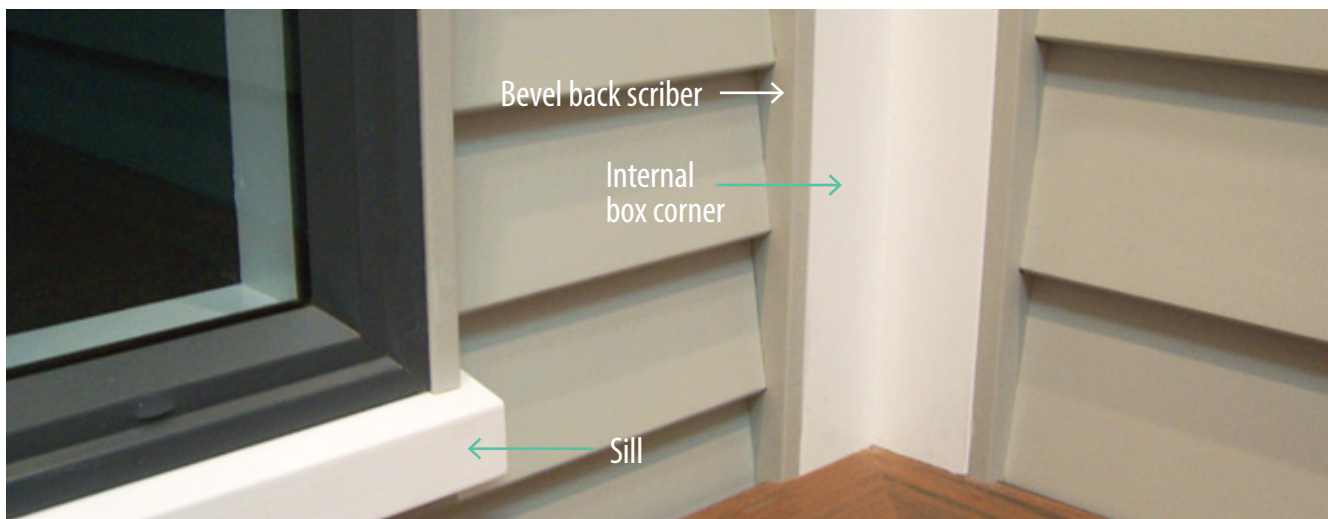

Re prime the cut ends with two coats of a premium quality timber primer, allowing to dry between coats.

Nails must be hand driven and punched below the surface to allow for filling. Prime then fill with an exterior grade wood filler immediately after nailing.

2.5 Aluminium window and door jambs

Window and door openings are a high weathertightness risk area and require particular attention to ensure weathertightness is achieved. All window and door openings must be constructed and trimmed in accordance with E2/AS1. All flashings, air seals, underlay and flexible flashing tapes must be in place.

For flashing details refer to NZS 3604 section 4 and E2/AS1 table 20 for durability requirements and E2/AS1 for flashing design and fabrication details.

As recommended in E2/AS1, window and door suppliers are responsible for head flashings.

The following instructions apply to aluminium windows and doors as set out in E2/AS1 9.1.10 - 9.1.10.8.

All windows must comply with NZS 4211 including consideration of the building location.

The aluminum facing flange must overlap the cladding (Envira weatherboard) by at least 10mm for jambs and at least 8mm for sills.

Fit firmly against the flange either an EnviraScribe or an Envira facing board and EnviraScribe combination. Pre-drill holes in the scribe and fix as per nailing schedule section 3.2 using JH hot-dipped galvanised or annular grooved stainless steel nails. Nail at 450mm centres.

Facing board fixings must be located 35-40mm above the lower edge of the overlapping board on every fourth board for 142mm wide weatherboards and every third board for 187mm wide weatherboards. Use two nails at each fixing point. For nails near the ends of the corner boards pre-drill the nail holes.

Direct fixed and cavity fixed cladding applications must have a sill tray flashing a minimum of the full width of the opening.

Re-prime the cut ends with two coats of a premium quality timber primer, allowing to dry between coats.

Nails must be hand driven and punched below the surface to allow for filling. Prime then fill with an exterior grade wood filler immediately after nailing.

Fit air seals around all window and door openings as specified.

2.6 Aluminium window and door sills

The Envira Weatherboard System requires a full width sill tray for direct fixed windows and doors, which meets the requirements of E2/AS1. If an Envira sill (plant on) is to be used, ensure the positioning of the sill does not compromise the sill flashing detail or function. The sill tray must extend at least 8mm behind the line of the aluminium frame.

In a cavity fix application, all doors and windows with a trim opening wider than 600mm require an appropriate sill support bar conforming to EM6, paragraph 9.1.10.5

2.7 Aluminium window and door heads

Direct and cavity fixed aluminium windows and doors require a flashing that meets the requirements of E2/AS1. The flashing must be fitted behind the cladding with a 5mm gap between the bottom edge of the cladding and the horizontal surface of the flashing. If an Envira Head Trim is to be used there must be a 5mm gap between the bottom edge of the head trim and the horizontal surface of the flashing.

2.8 Timber window and door openings

When used in combination, timber framed windows and timber cladding are not covered by E2/AS1 and application for an Alternative Solution to New Zealand Building Code Clause E2 must be made to the Building Consent Authority. Timber window and door installations must include facing boards and scribes when used in combination with the Envira Weatherboard System.

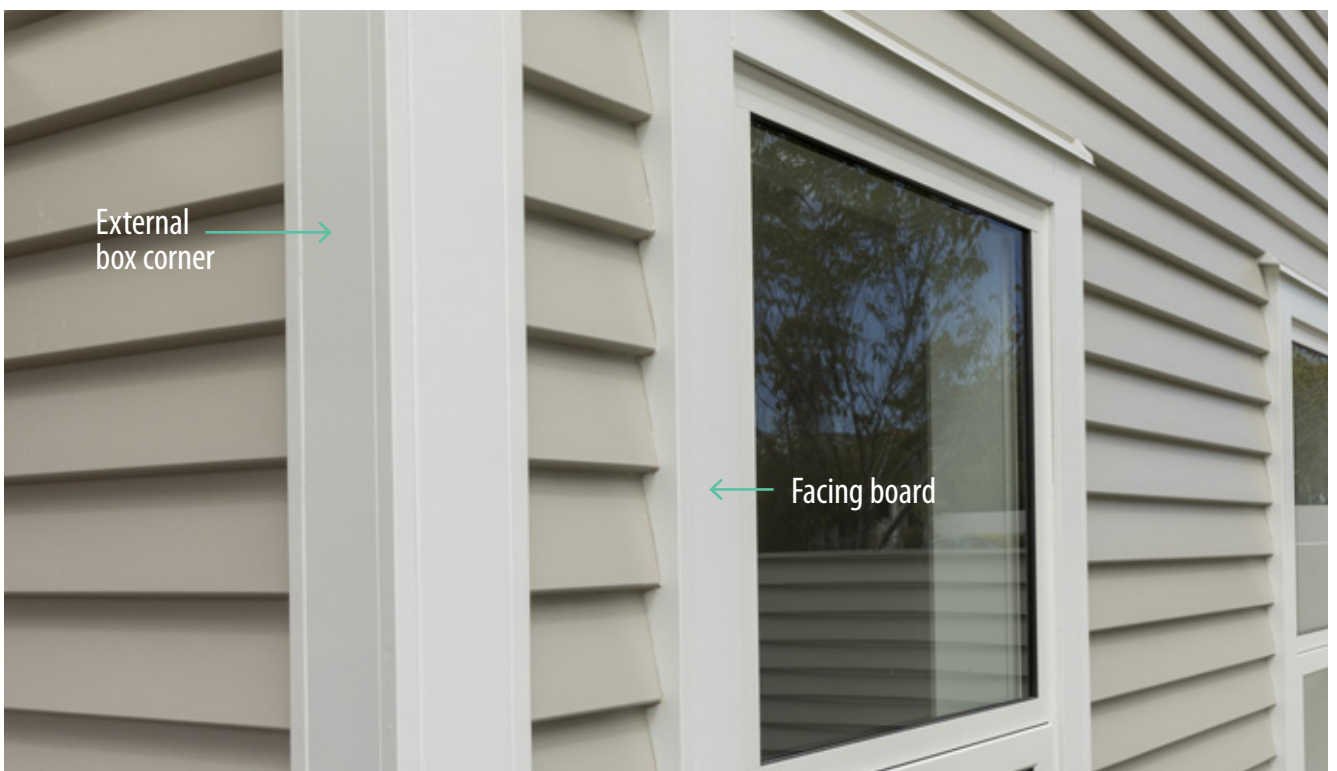

NAILING

3.1 Nail selection

Selection of proper nails is important.

Use Jolt Head (JH) hot-dipped galvanised or stainless steel annular grooved, for fixing either directly into framing or structural batten.

Do not use plain or electroplated nails. Hot dipped galvanising must meet the requirements of AS/NZS 4680:2006.

Please check for updates on Niagara's website - www.niagara.nz

Download 2D drawing files in PDF, DWG or DXF format online.

Bevel Back, Rusticated and Shiplap technical manuals are available for download at www.niagara.nz/brochures

3.2 Bevel back nailing schedule

Timber size (mm)	Envira component	Recommended minimum nail size	Section
142 x 18 187 x 18	Bevel back direct fixed weatherboard	75 x 3.15	2.1
142 x 18 187 x 18	Bevel back cavity fixed weatherboard	75 x 3.15	2.1
142 x 21 190 x 21	Bevel back direct fixed weatherboard	75 x 3.15	2.1
142 x 21 190 x 21	Bevel back cavity fixed weatherboard	75 x 3.15	2.1
100 x 100	External and internal box corners	50 x 2.50	2.3, 2.4
All sizes	Facing boards	50 x 2.50	2.5
40 x 10	EnviraScribe pre-cut scribe	30 x 2.00	2.3, 2.4, 2.5
40 x 18	EnviraScribe pre-cut scribe	50 x 2.00	2.3, 2.4, 2.5
90 x 42 65 x 42	Sills	75 x 3.15	2.6
40 x 27 18 x 18	Eaves mould	60 x 2.80	2.1
82 x 38	Head trim	60 x 2.80	2.7
50 x 19	Door sill trim	50 x 2.50	
44 x 20	Cavity batten	60 x 2.80	1.10

3.3 Nailing guidelines

Proper application and nailing practices are essential for maximising the product performance and appearance.

All nailing should be over studs with at least 35mm penetration into the frame.

Nailing should be such that it does not restrict normal seasonal movement, so do not nail through overlapping pieces.

Hand nailing is recommended as nail guns can cause damage to the surface of the board. If a nail gun is used a non-marking attachment should be used to avoid damage to the board surface.

Nails are to be countersunk (punched) by 2mm and must be primed immediately then filled to avoid moisture uptake around the nail head*.

Pre-drilling near the ends is recommended as a precaution to avoid the possibility of end splitting. We recommend the use of scarf joints.

Butt joints can be used without an expansion gap, but these must be flashed. Joints should be staggered up the wall. Scarf joints should face away from the prevailing winds.

***Prime all nail holes with a suitable premium exterior wood primer then fill with an exterior grade wood filler.**

Sealants must not be relied upon for primary weather protection, they are used to assist with weathering at joint and laps only. All filled areas must be spot primed prior to top coating.

3.4 Bevel Back Temporary Fixing Method

- Envira weatherboards can be brad nailed at the top above the weather groove to temporarily fix the weatherboard in place before face nailing. The brad nails must be galvanised or stainless steel, 32mm long maximum or less, and 2mm diameter or less.
- The brad nail is to be fixed on the **minimum** number of studs necessary to hold the weatherboard in the correct position and no more than one brad nail per stud maximum.
- Pre-drill the envira weatherboard (to avoid splitting) for nail or brad locations within 50mm of the board ends.

3.5 Screw Fixing Option

Envira Bevel Back Weatherboards are also able to be fixed by using specifically designed timber weatherboard screws.

These must be either 7G or 8G, length and fixing point is to match the same required when using nail fixings. Screws can be galvanised, or stainless steel if preferred.

Options are:

ECKO T-REX17 8Gx75mm Weatherboard Jolt Screw on both direct and cavity fix.

Simpson Strong-Tie 7Gx75mm Weatherboard Screw on both direct and cavity fix.

All sealing, filling and priming is exactly the same procedure as under 3.3 Nailing guidelines.

PAINTING AND MAINTENANCE

4.1 Moisture content

The primer will not protect against moisture uptake, which can result in dimensional swelling. If swelling or distortion of the timber is evident, the product must be given time to dry out and return to its equilibrium moisture content and manufactured dimensions before any top coats are applied.

4.2 Preparation

- Remove all loose material and dirt.
- Primers will not withstand extended periods exposed to the elements and may require a light sand.
- Sand and spot prime all bare patches or where the factory primer has been damaged.
- Sand smooth and spot prime all filled areas
- Fill all nail holes with an exterior grade wood filler and seal all notches, end cuts and nail holes with a suitable primer/undercoat or end sealing product such as Envira Fast Dry End Seal.

It is the painter's responsibility to ensure all surfaces are correctly prepared prior to painting including ensuring that the primer is well-adhered to the timber substrate and that all surfaces are in a suitable condition before top coating.

It is recommended that at a minimum the top lap of the boards are coated with top coat approximately 50mm down from the top edge.

This will eliminate a primer line showing if the boards move with the seasonal change that can occur. Ideally the boards would receive a full top coat before installation.

4.3 Top coat selection

Use only a premium quality house paint that has a Light Reflective Value (LRV) of 45 or higher and a gloss level of 10 per cent or more.

Note: The higher the gloss level, the higher the durability.

Timber is a natural product and resin is a natural constituent of all timber. Timber painted in dark colours (LRV less than 45) may produce resin bleed.

4.4 Painting

All preparation and painting must be carried out in a good tradesman-like manner and to the current requirements of AS/NZS 2311 Guide to Painting of buildings and the paint manufacturer's data sheet.

Two top coats of quality house paint should be applied within six weeks of the product being installed. If painting does not occur within six weeks of installation, sanding and repriming will be required.

Paint must be applied with the necessary equipment and experience under the appropriate environmental conditions to ensure that the potential of the paint system is maximised.

Total film build, including primer should exceed 100 Dry Micron.

Do not top coat Envira timber products that have moisture-related dimensional swelling. This will help avoid shrinkage lines that may occur in the top coat as the timber returns to its equilibrium moisture content and manufactured dimensions.

4.5 Maintenance

All new buildings will 'settle' and during this process the integrity of the paint system, no matter what type of substrate it has been applied to, may be compromised resulting in minor touch up work being required. If re-priming is necessary, use only a premium quality primer and the original top coat paint for touch up work.

Like washing your car, cleaning your house will help it maintain its good looks for much longer. Airborne contaminants, including salt deposits, which settle on your paint film, can attack the surface and cause premature breakdown. Annual washing of your home will help maintain the fresh appearance of your paintwork.

The presence of moss, mould and lichen will hold moisture on the surface longer, promoting further growth of these organisms and increasing the risk of damage to the coating and substrate. As with any painted surface, regular inspection and immediate repairs to areas of flaking or cracked paint are essential and will stop the entry of moisture into the substrate.

Particular attention should be paid to areas of high weathertightness risk such as around windows and doors, checking that flashings and sealants are in good condition and performing as required. Repair immediately if the building weathertightness has been compromised.

BEVEL BACK DIRECT FIX

Bevel Back Direct Fix **Foundation Timber**
1001 2D:

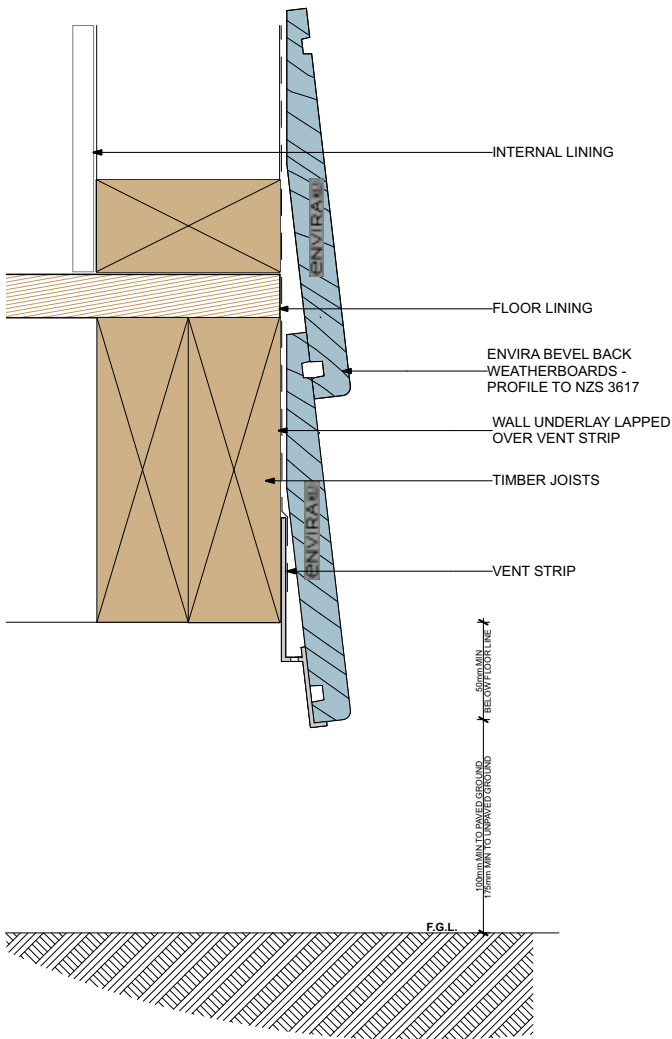

Bevel Back Direct Fix **Foundation Concrete**
1002 2D:

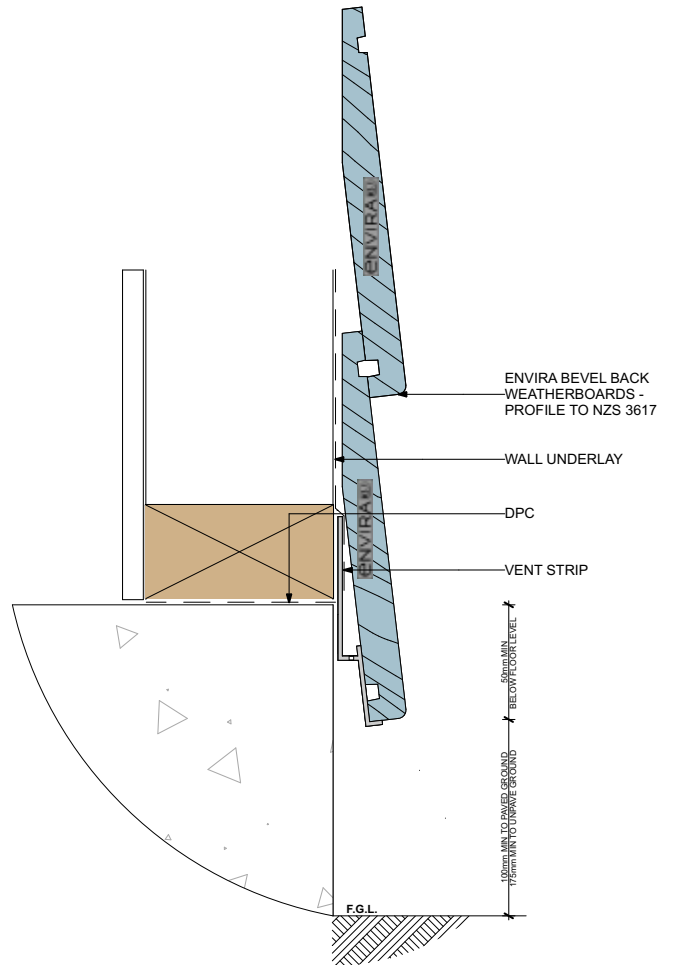

DATE: 16/04/2024 check for updates and download
2D files in PDF, DWG or DXF format at www.niagara.nz

Bevel Back Direct Fix Door Sill

1003 2D :

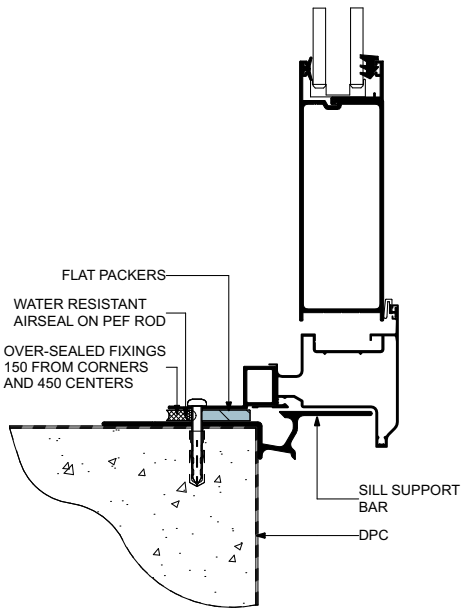

Bevel Back Direct Fix Door Jamb

1004 2D :

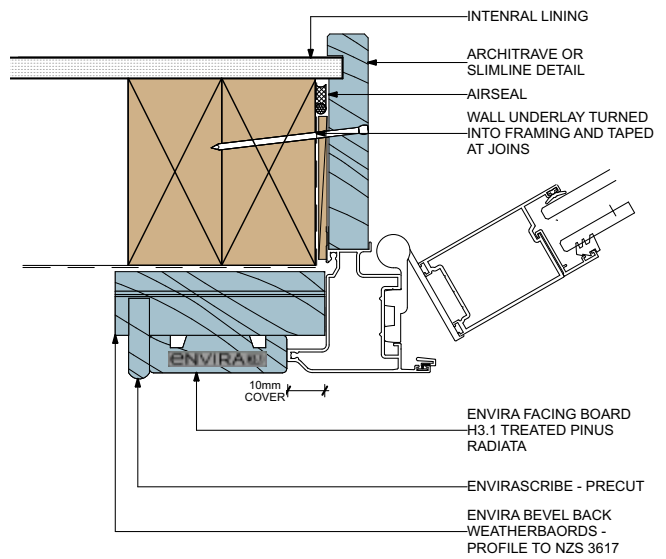

Bevel Back Direct Fix Door Head

1005 2D :

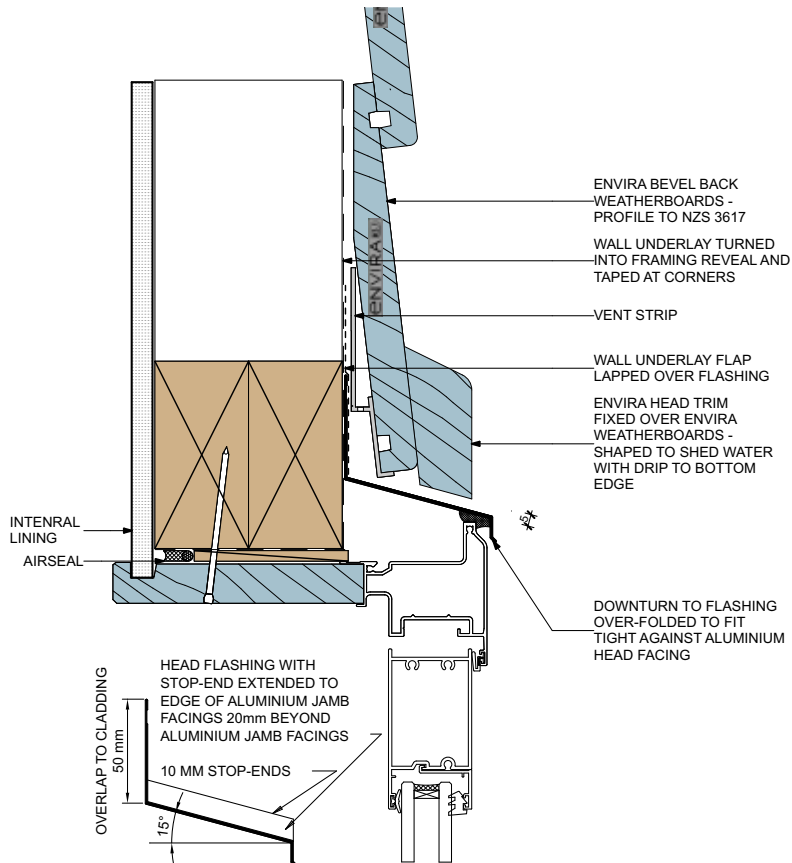

FLASHING DIMENSIONS

Bevel Back Direct Fix Window Sill

1006 2D :

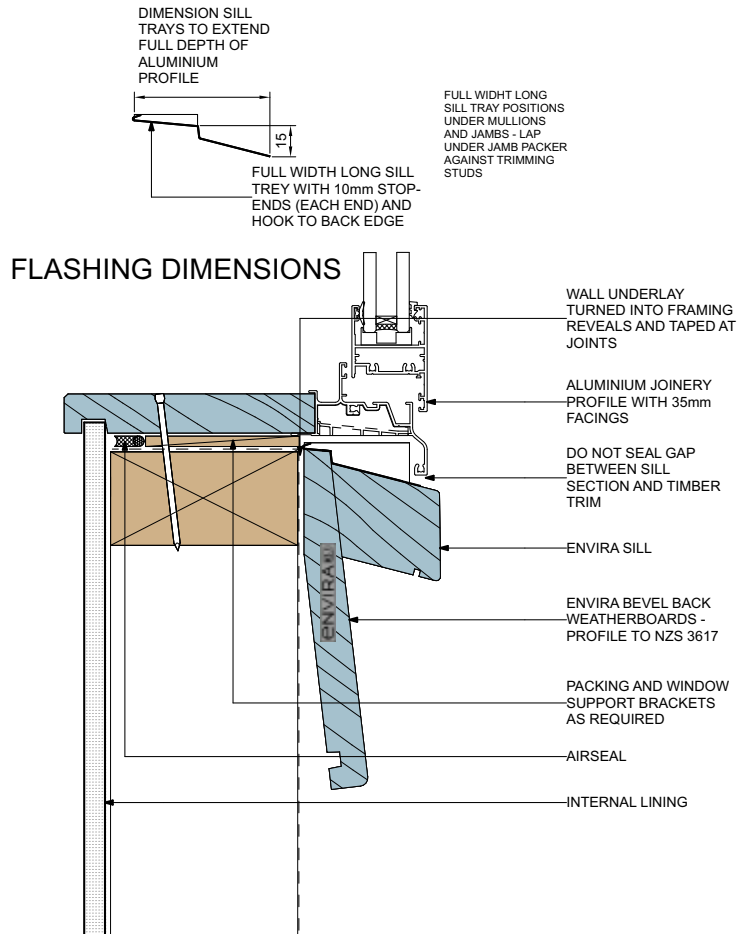

Bevel Back Direct Fix Window Jamb

1007 2D :

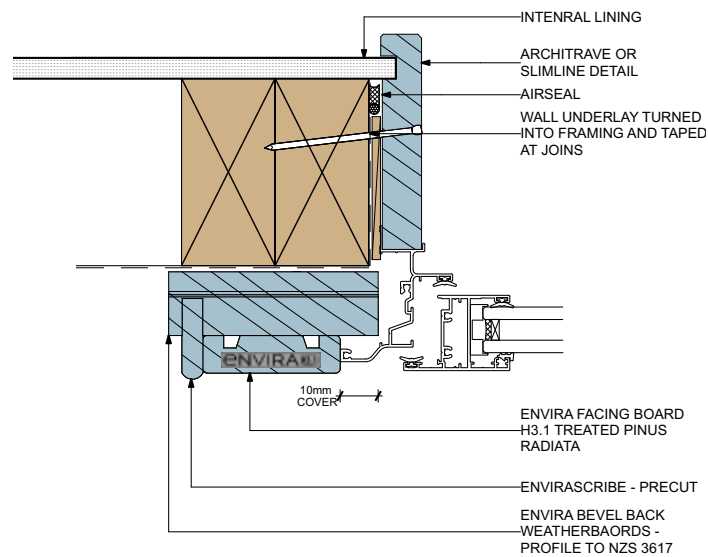

DATE: 16/04/2024 check for updates and download 2D files in PDF, DWG or DXF format at www.niagara.nz

Bevel Back Direct Fix Window Head

1008 2D :

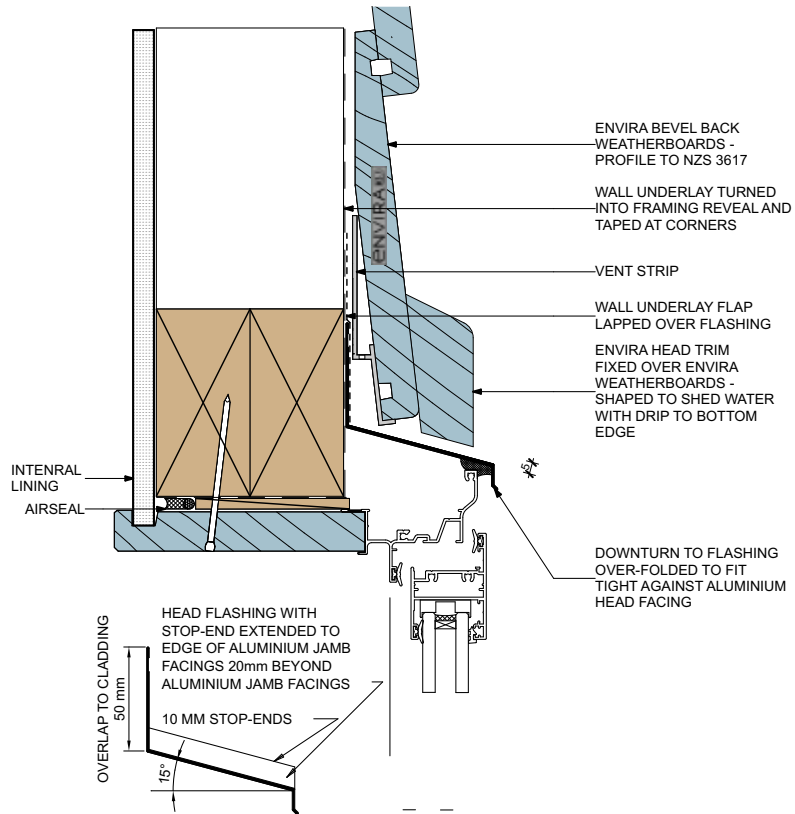

FLASHING DIMENSIONS

Bevel Back Direct Fix Soffit

1009 2D :

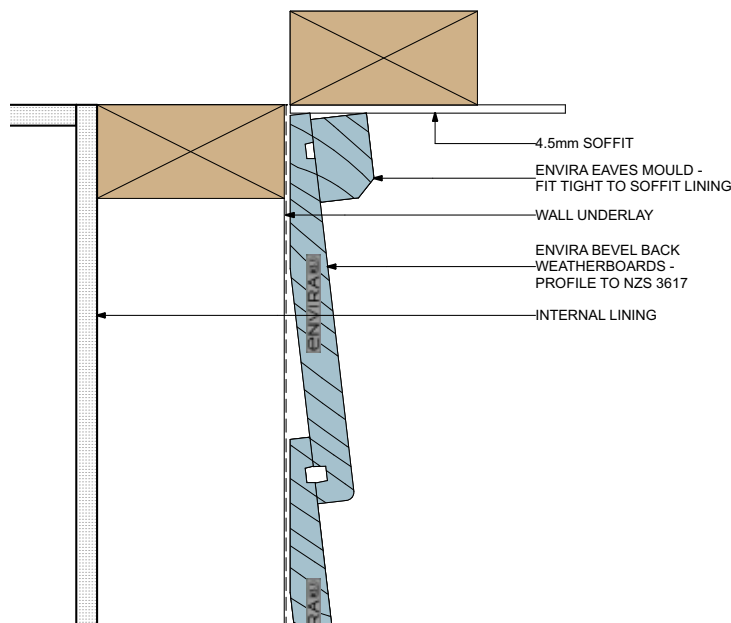

Bevel Back Direct Fix External Corner

1010 2D:

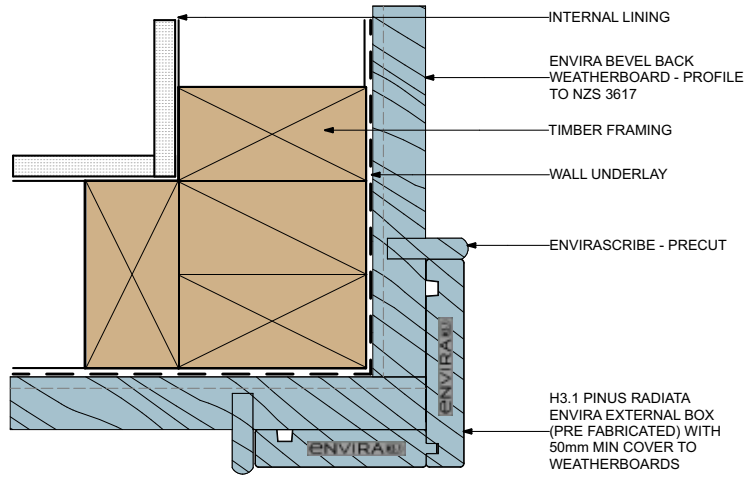

Bevel Back Direct Fix Internal Corner

1011 2D:

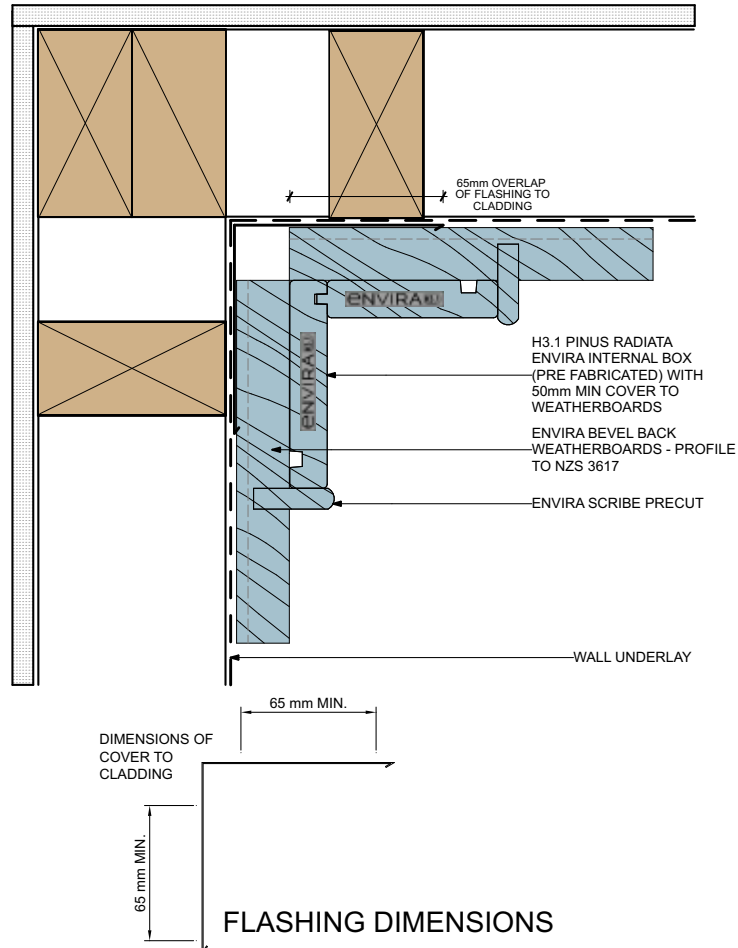

Bevel Back Direct Fix Meter Box Head

1012 2D :

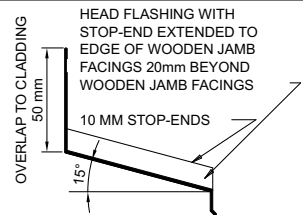
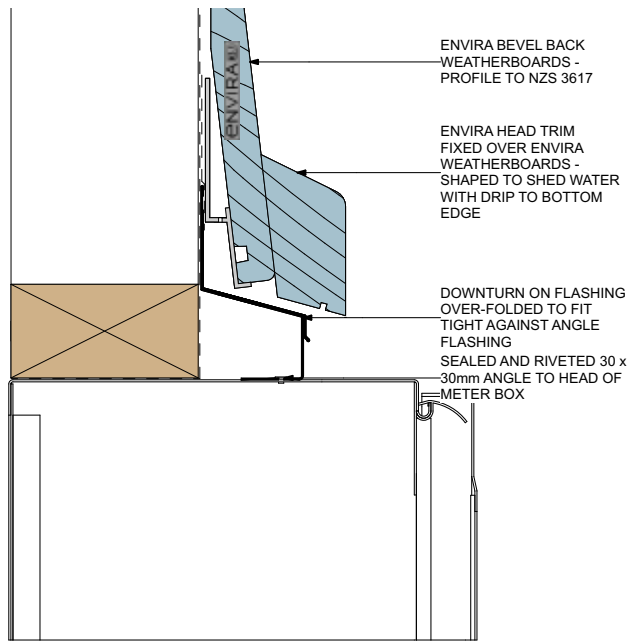

FLASHING DIMENSIONS

Bevel Back Direct Fix Meter Box Jamb

1013 2D :

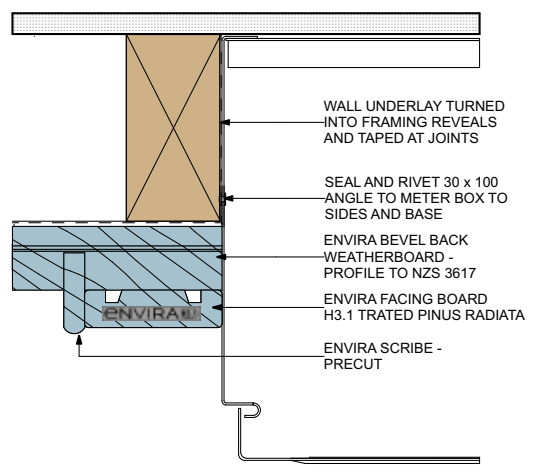

Bevel Back Direct Fix Meter Box Sill

1014 2D :

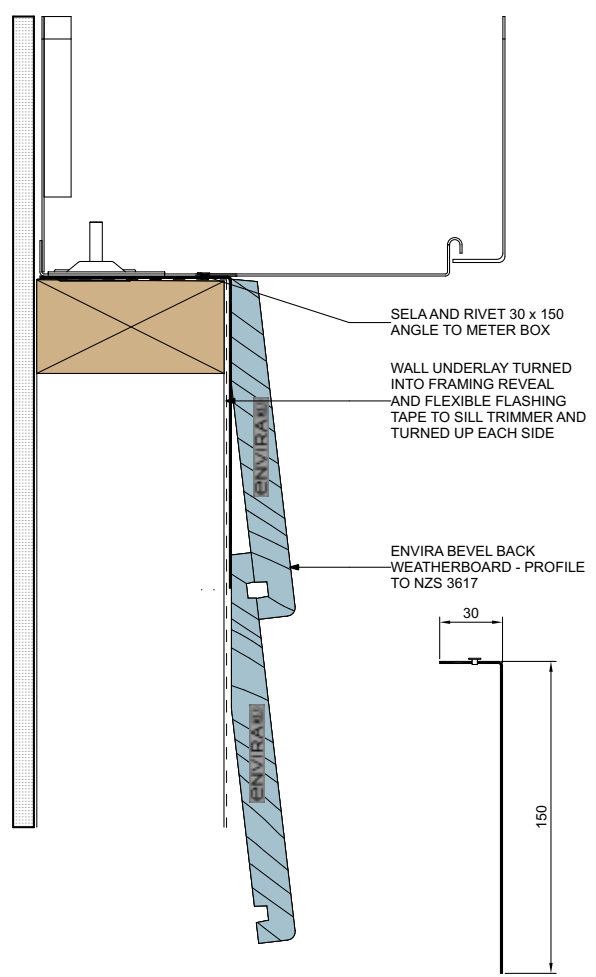

FLASHING DIMENSIONS

Bevel Back Direct Fix Pipe Penetration

1015 2D :

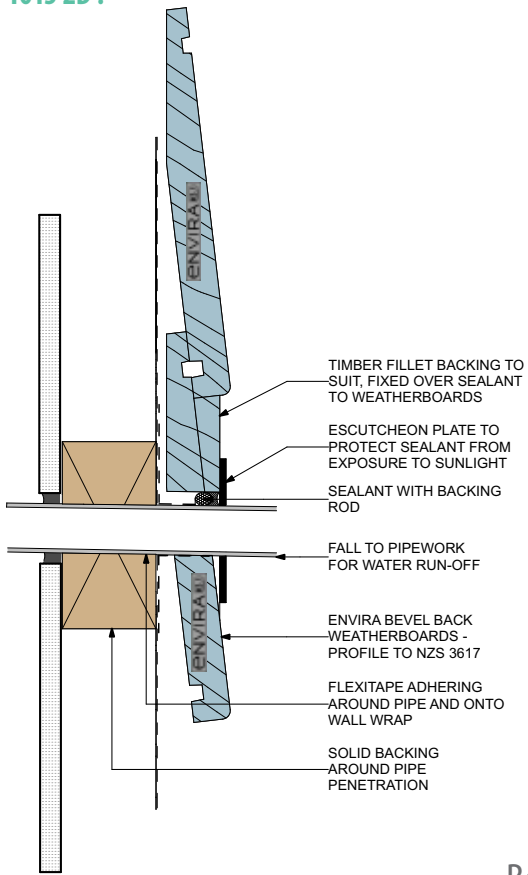

Bevel Back Direct Fix Fascia Eaves

1016 2D :

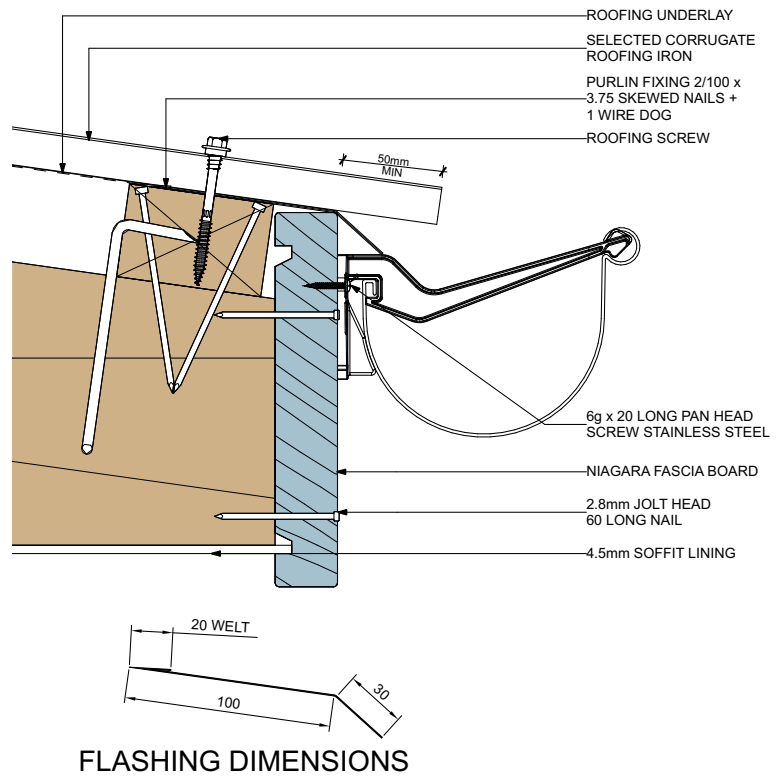

Bevel Back Direct Fix Apron

1017 2D :

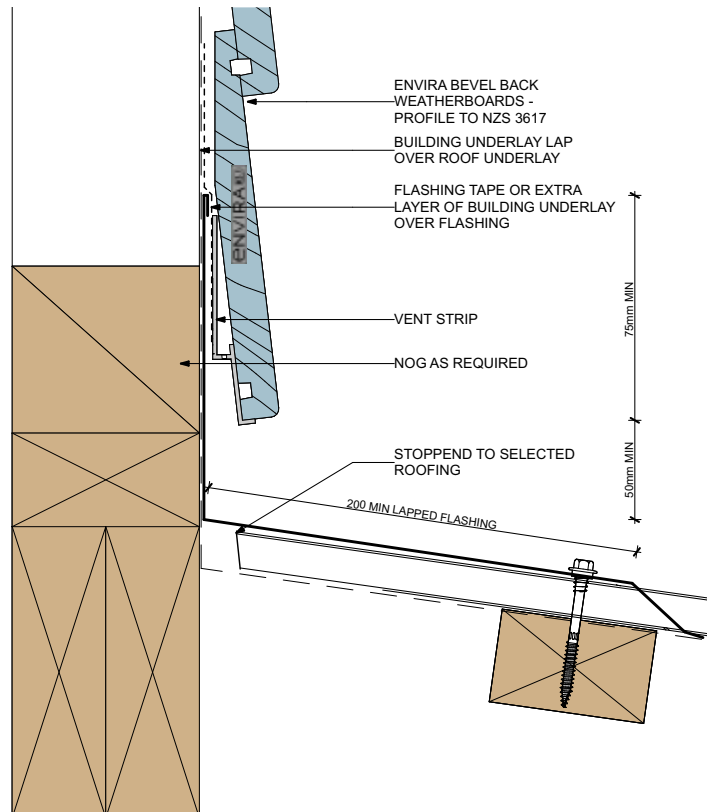

DATE: 16/04/2024 check for updates and download 2D files in PDF, DWG or DXF format at www.niagara.nz

Bevel Back Direct Fix Parapet Cap

1018 2D :

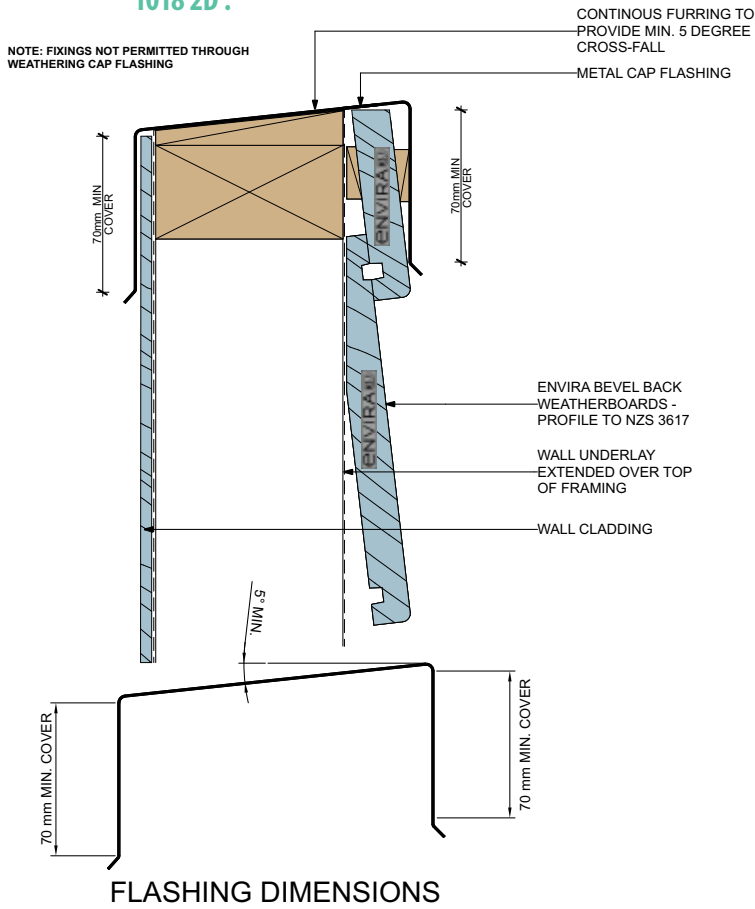

Bevel Back Direct Fix Stucco - Below

1019 2D :

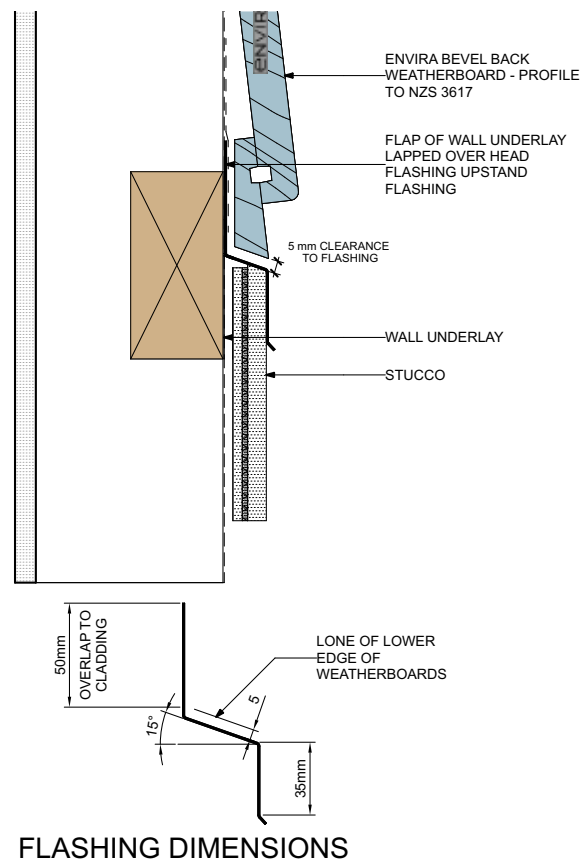

Bevel Back Direct Fix Stucco - Internal Corner

1020 2D :

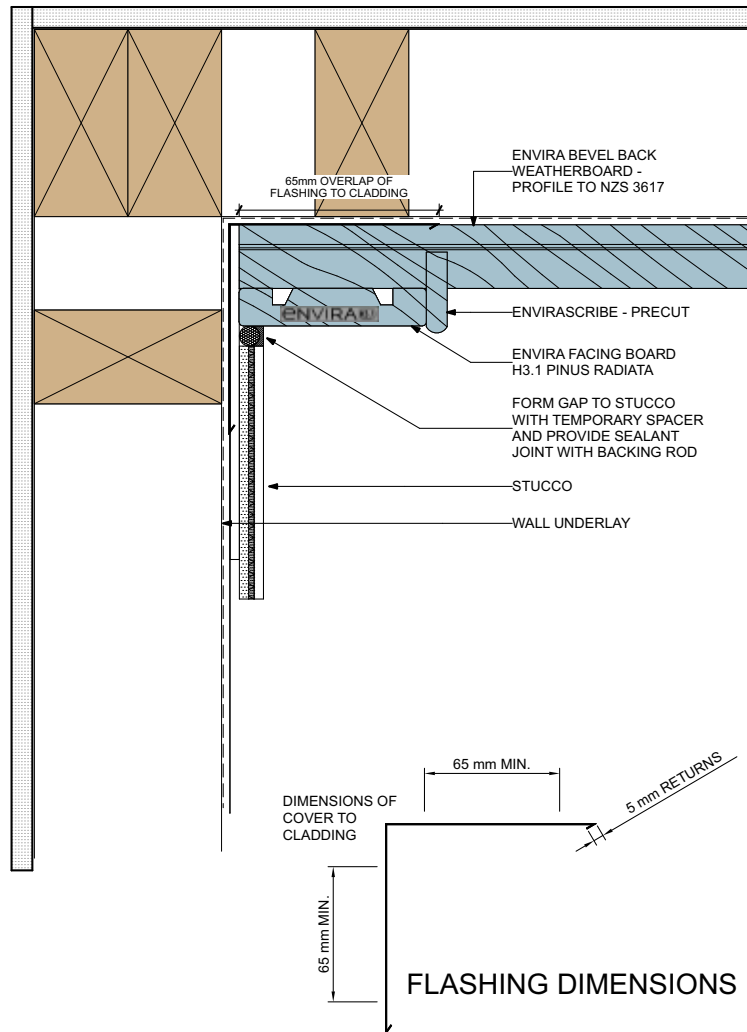

Bevel Back Direct Fix Stucco - External Corner

1021 2D :

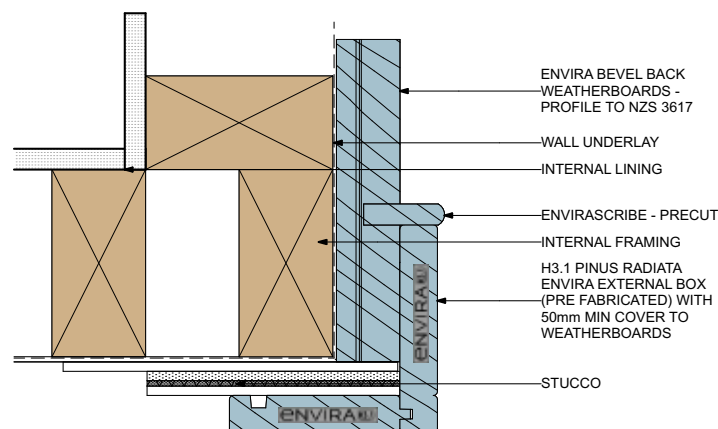

DATE: 16/04/2024 check for updates and download
2D files in PDF, DWG or DXF format at www.niagara.nz

Bevel Back Direct Fix **Profiled Metal - Above**
1022 2D :

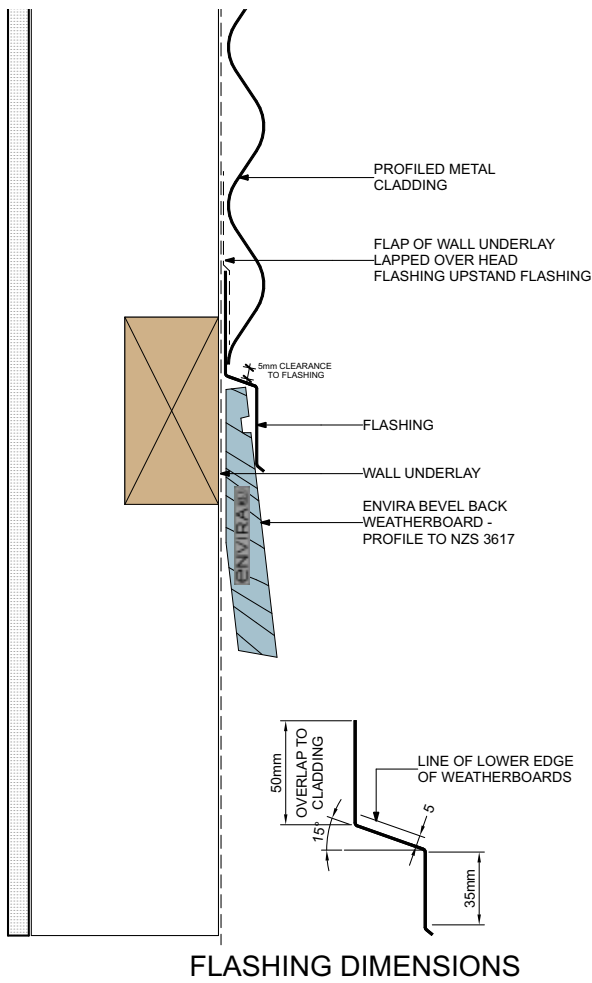

Bevel Back Direct Fix **Profiled Metal - Below**
1023 2D :

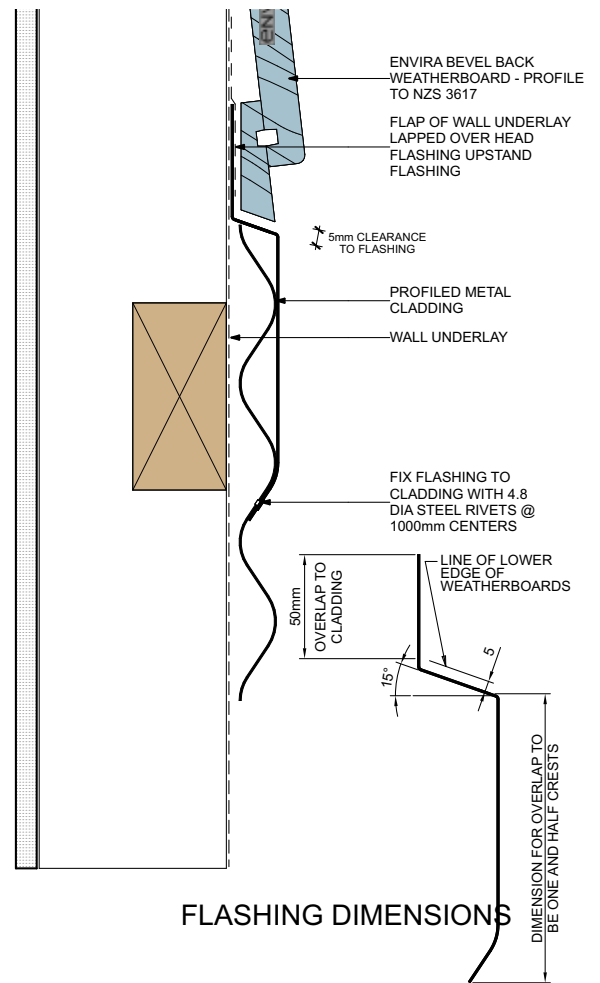

Bevel Back Direct Fix **Profiled Metal - Abutting**

1024 2D :

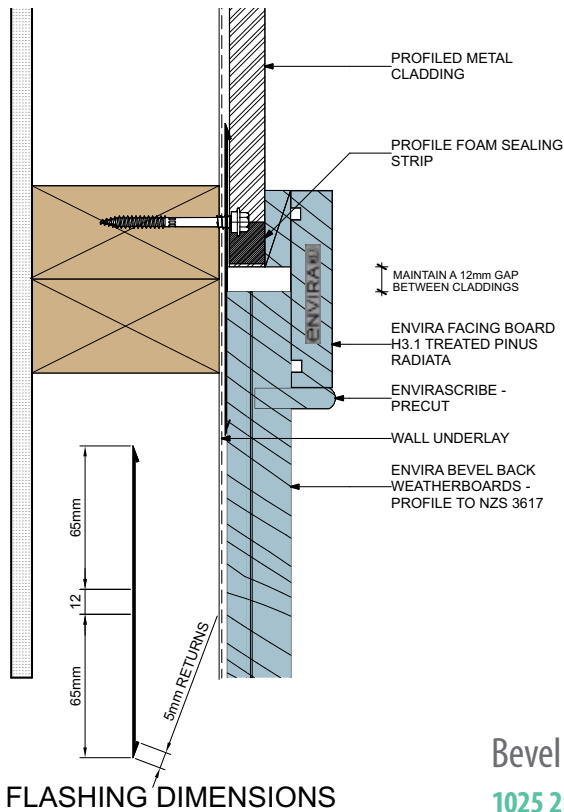

Bevel Back Direct Fix **Profiled Metal - Internal Corner**

1025 2D :

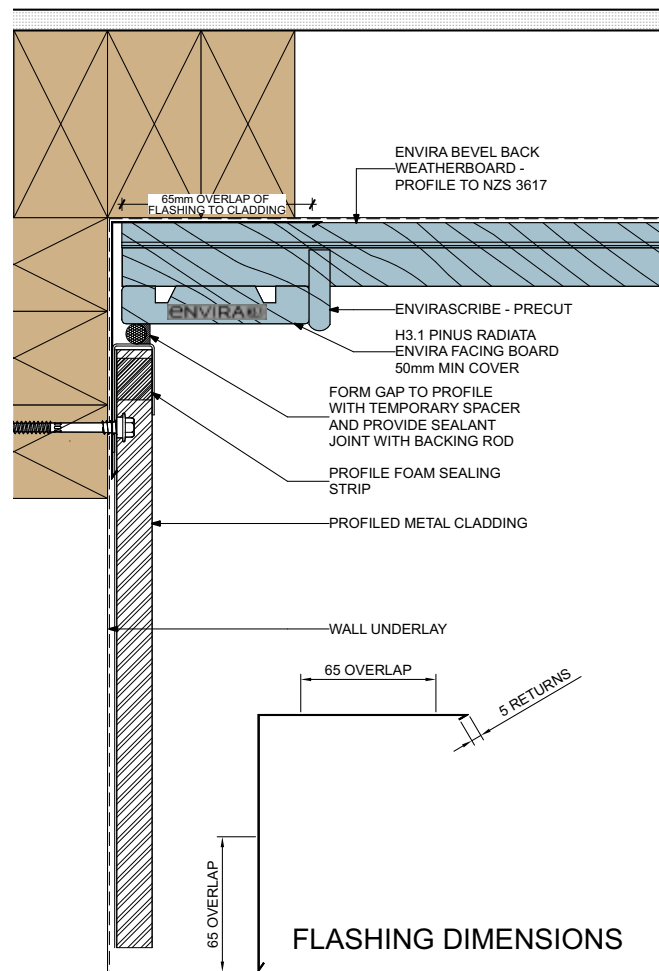

Bevel Back Direct Fix **Profiled Metal - External Corner**

1026 2D :

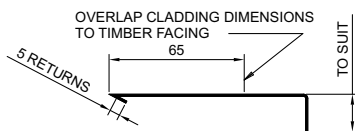
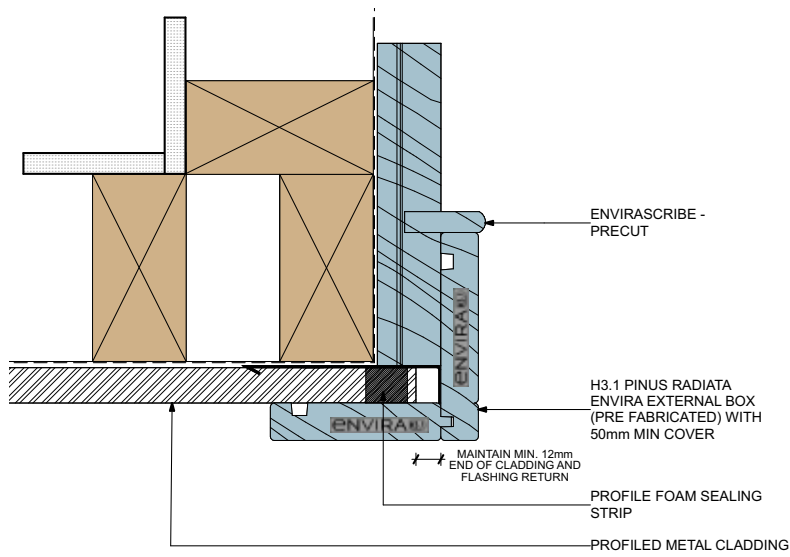

FLASHING DIMENSIONS

Bevel Back Direct Fix **Masonry Veneer - Below**

1027 2D :

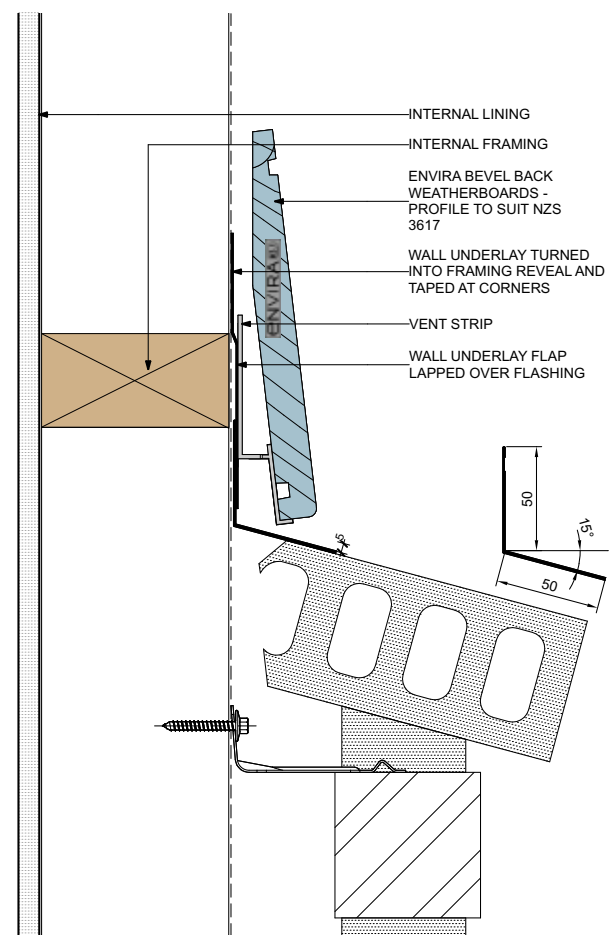

Bevel Back Direct Fix Masonry Veneer - Abutting

1028 2D :

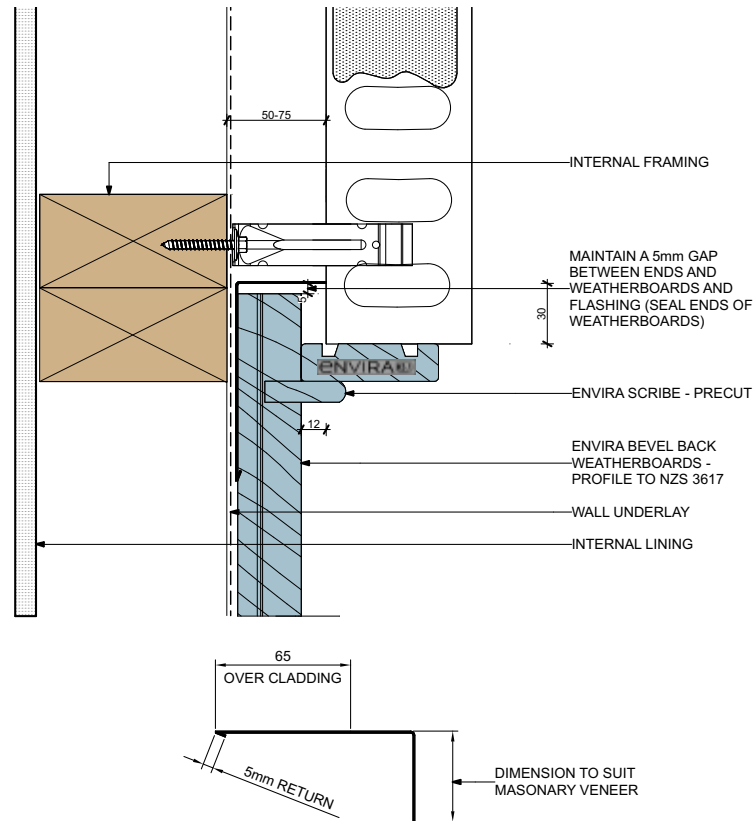

FLASHING DIMENSIONS

Bevel Back Direct Fix Masonry Veneer - Internal Corner

1029 2D :

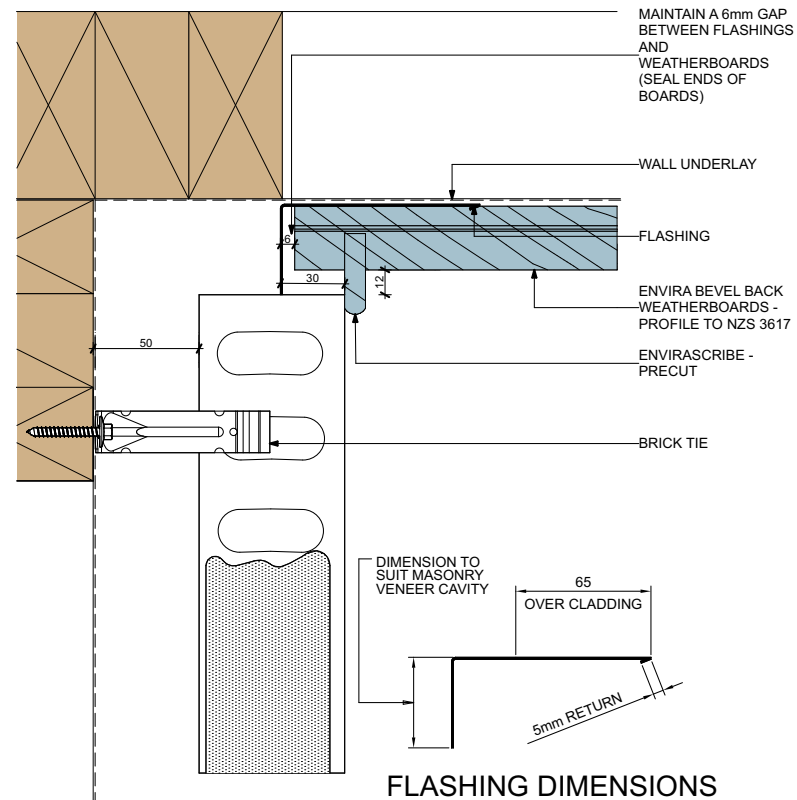

FLASHING DIMENSIONS

Bevel Back Direct Fix Masonry Veneer - External Corner

1030 2D :

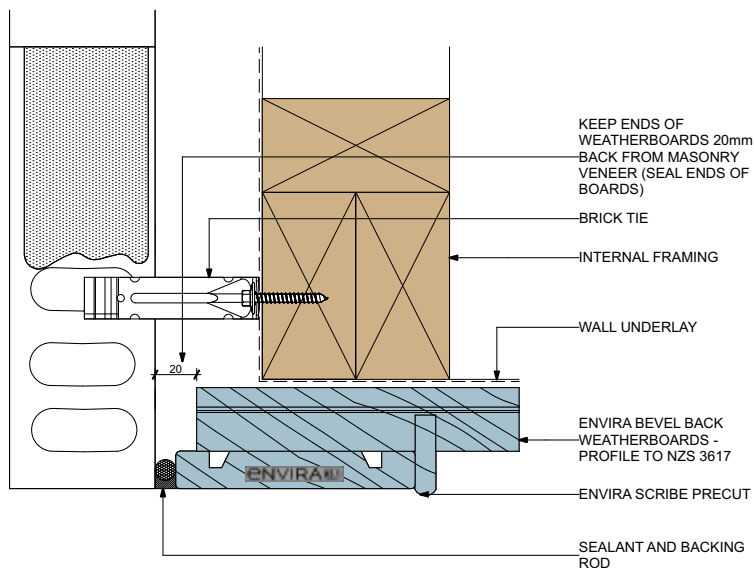

Bevel Back Direct Fix Above Waterproof Deck

1031 2D :

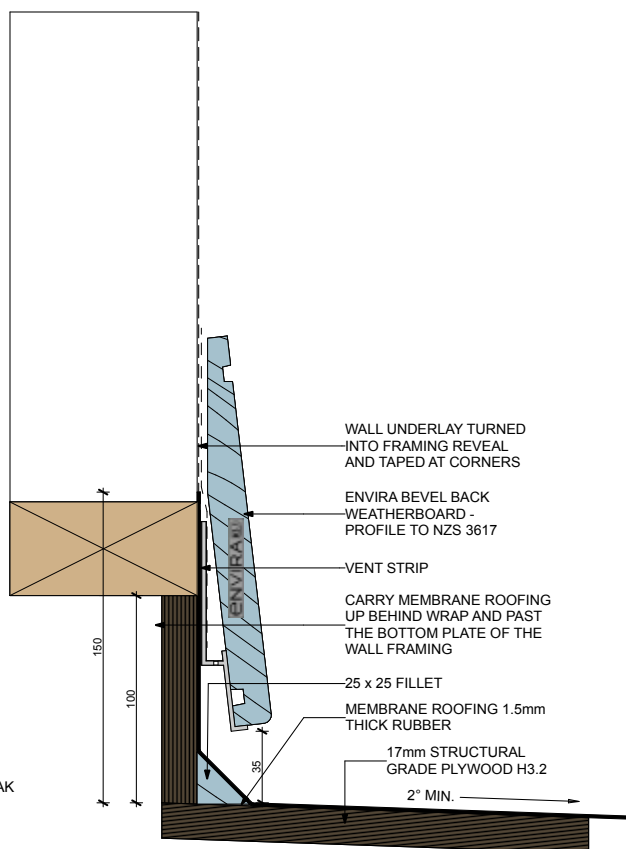

Bevel Back Direct Fix Mid-Floor Junction

1032 2D :

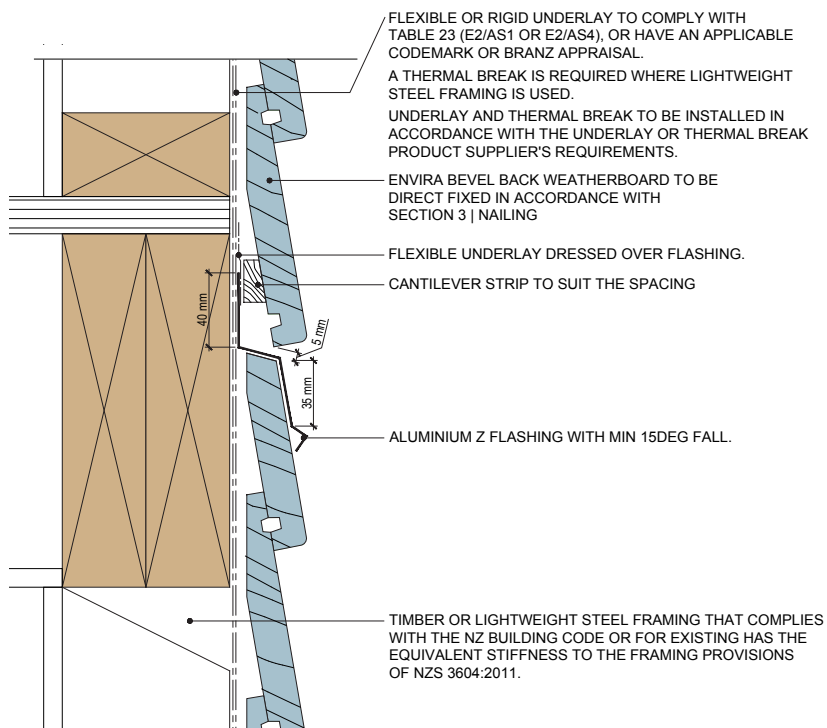

BEVEL BACK CAVITY FIX

Bevel Back Cavity Fix **Foundation Timber**

3001 2D :

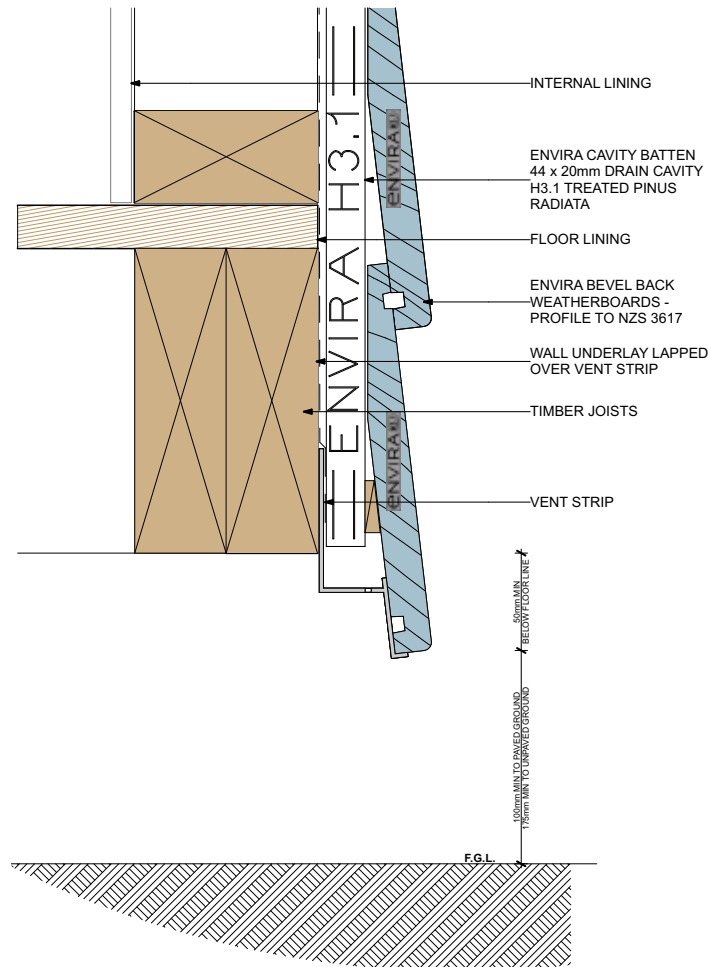

Please check for updates on Niagara's website - www.niagara.nz

Download 2D drawing files in PDF, DWG or DXF format online.

Bevel Back, Rusticated and Shiplap technical manuals are available for download at www.niagara.nz/brochures

DATE: 16/04/2024 check for updates and download 2D files in PDF, DWG or DXF format at www.niagara.nz

Bevel Back Cavity Fix Foundation Concrete

3002 2D :

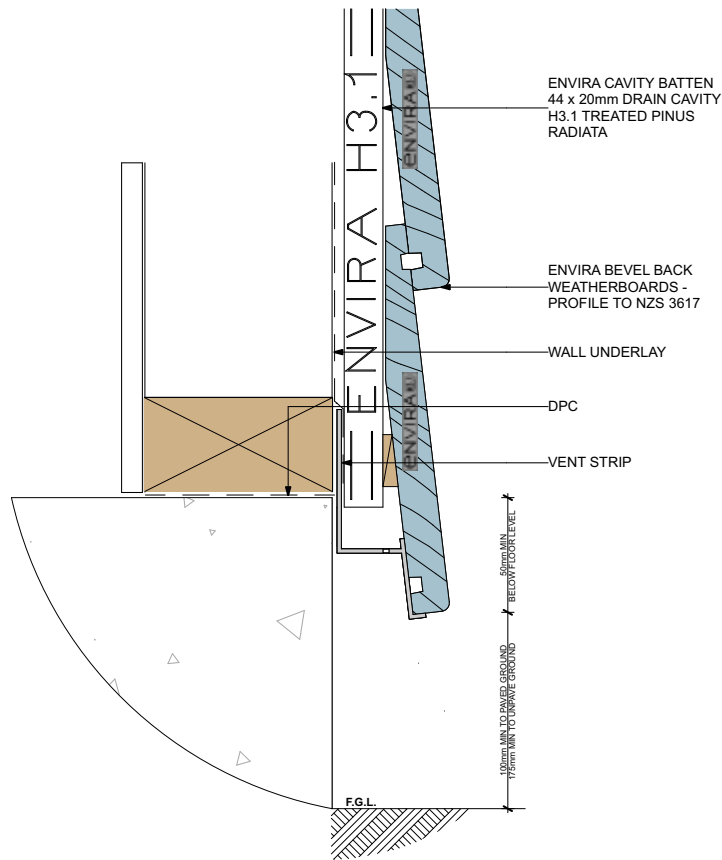

Bevel Back Cavity Fix Door Sill

3003 2D :

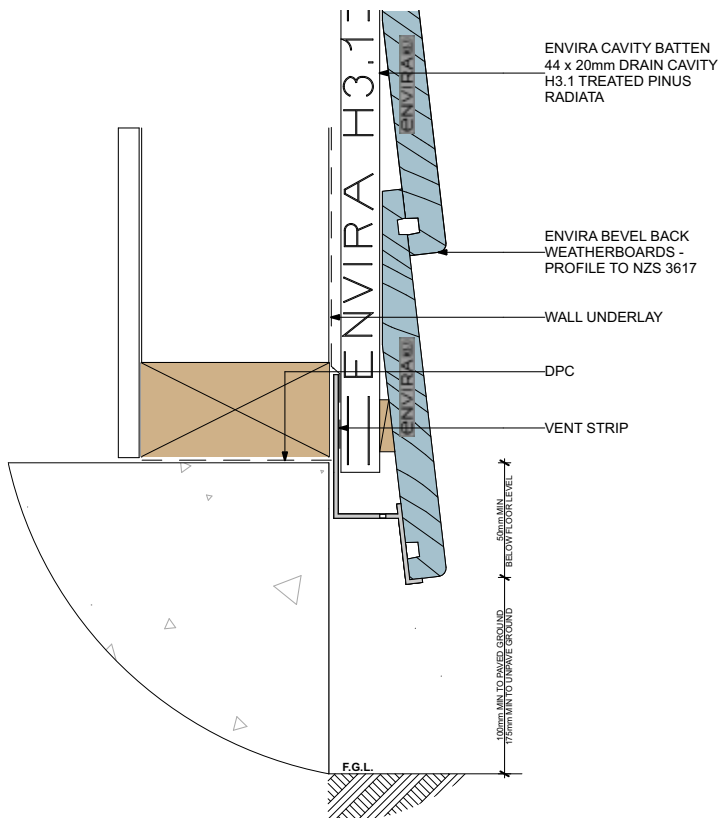

Bevel Back Cavity Fix Door Jamb

3004 2D :

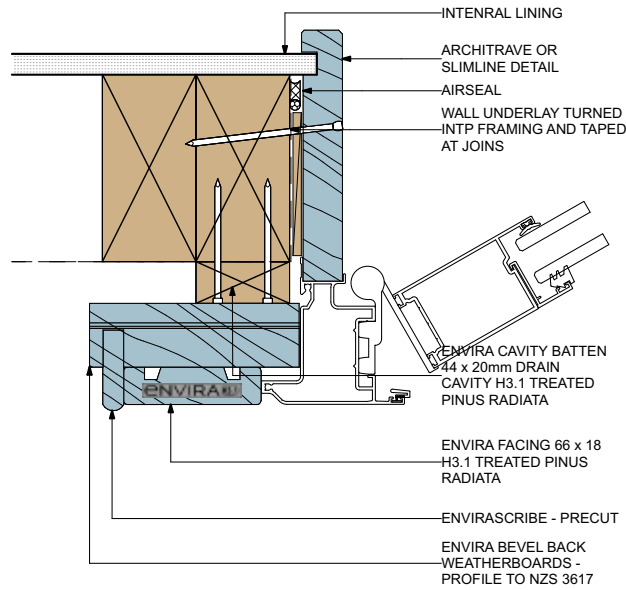

Bevel Back Cavity Fix Door Head

3005 2D :

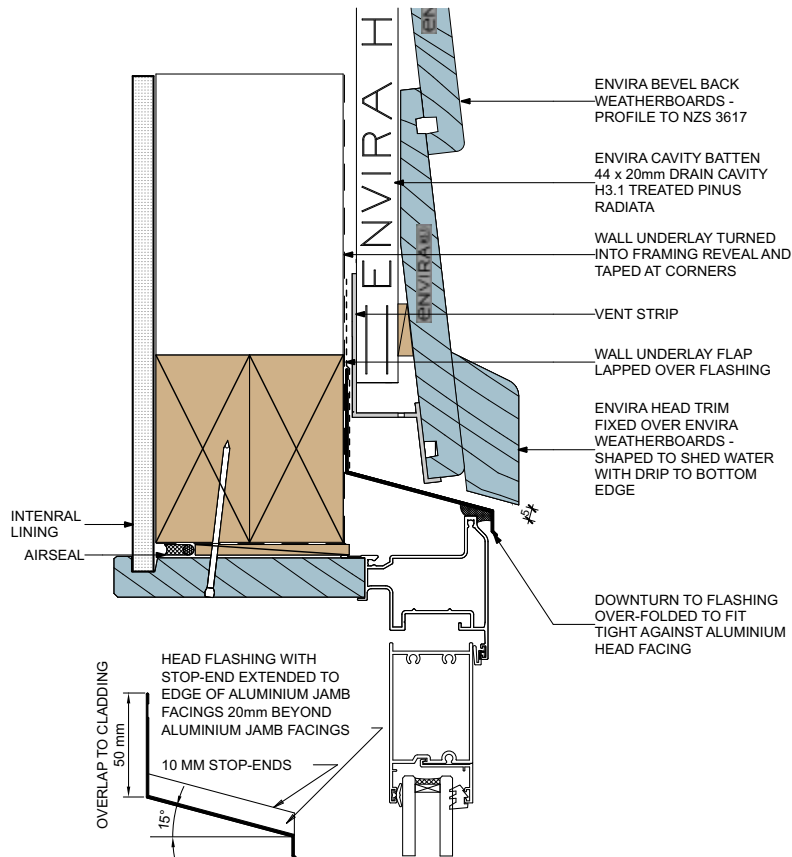

FLASHING DIMENSIONS

Bevel Back Cavity Fix Window Sill

3006 2D :

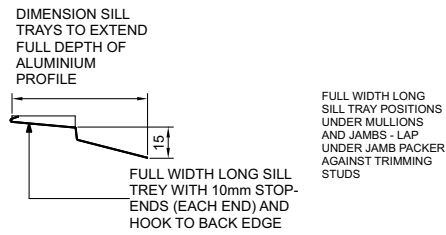

FLASHING DIMENSIONS

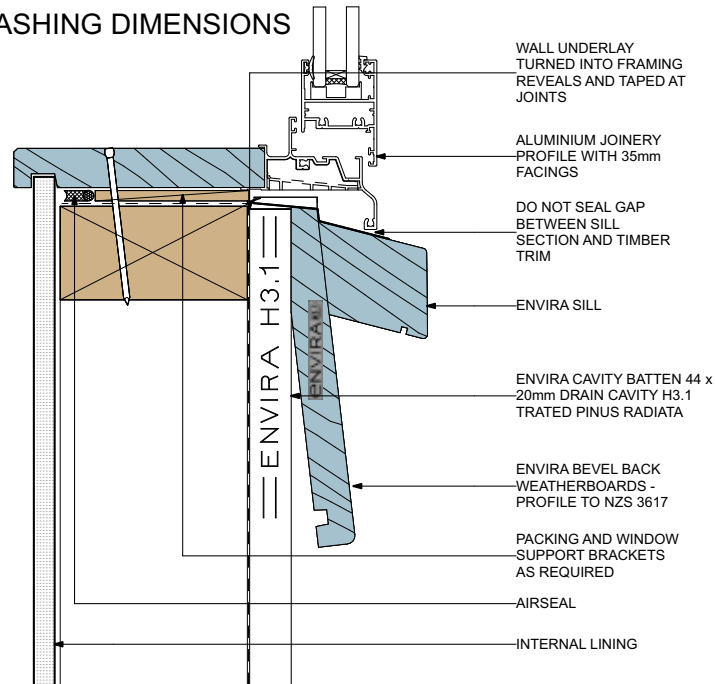

Bevel Back Cavity Fix Window Sill (Support Bar)

3006 A 2D :

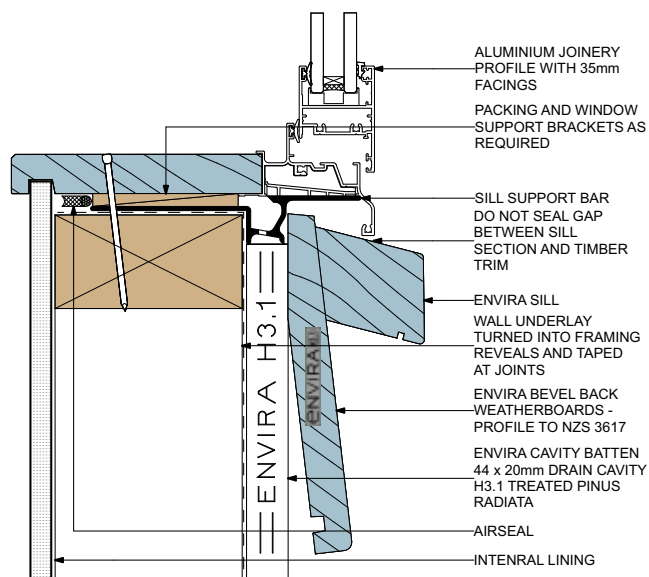

Bevel Back Cavity Fix Window Jamb

3007 2D :

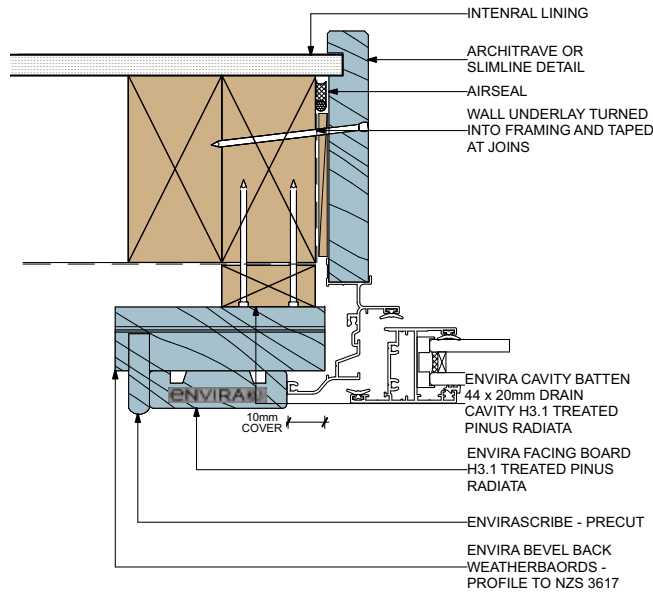

Bevel Back Cavity Fix Window Head

3008 2D :

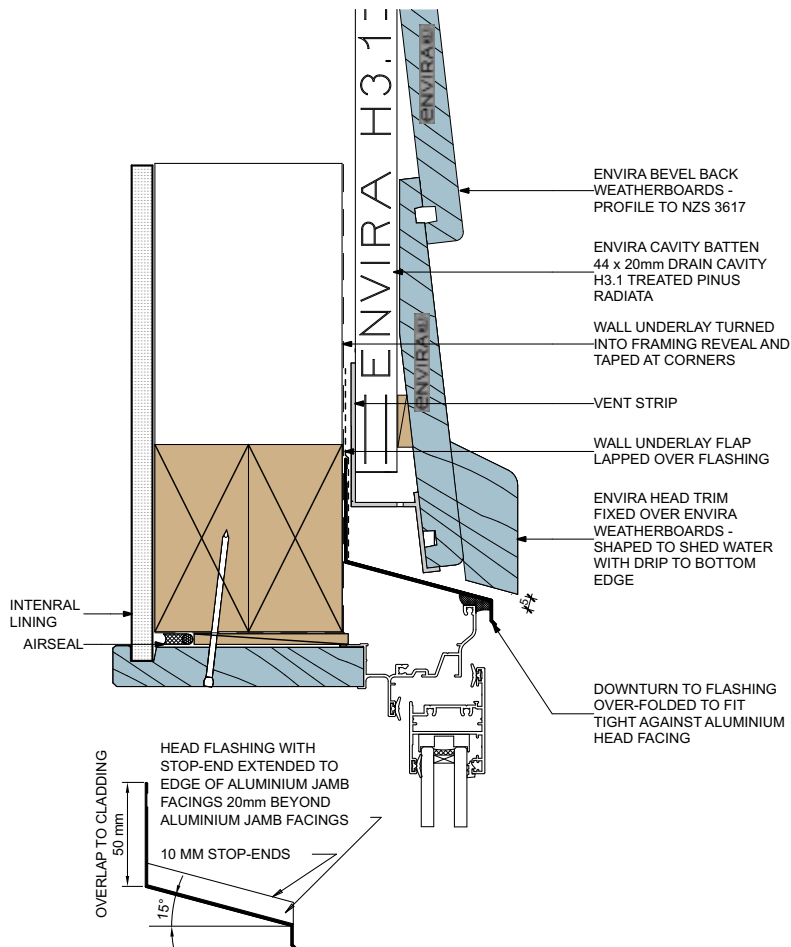

Bevel Back Cavity Fix Window Head - Option A

3008 A 2D :

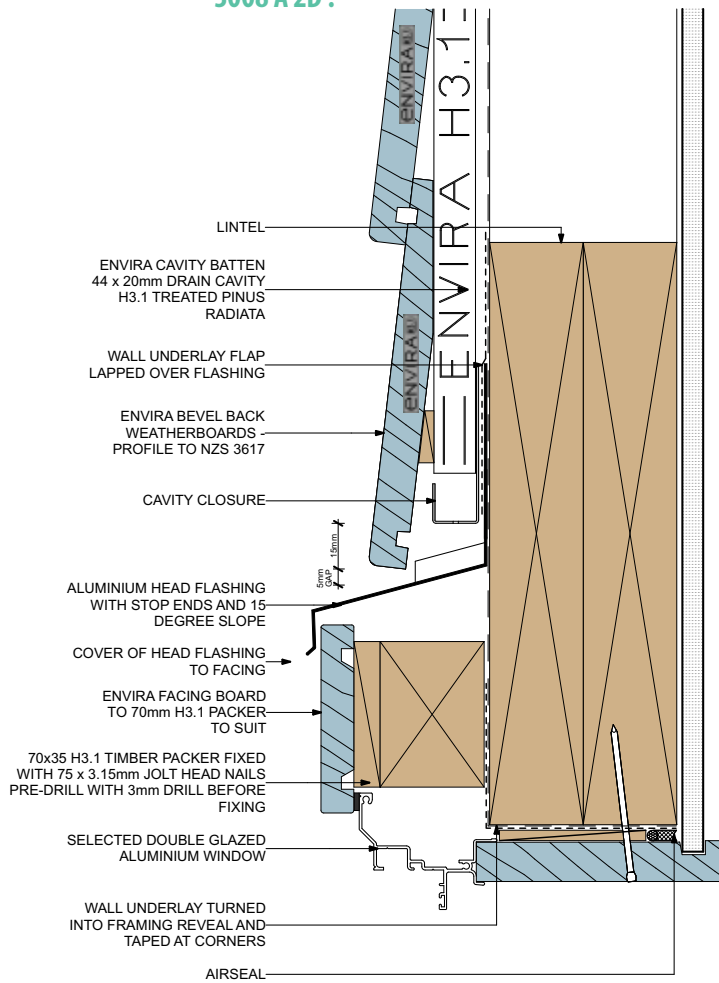

Bevel Back Cavity Fix Soffit

3009 2D :

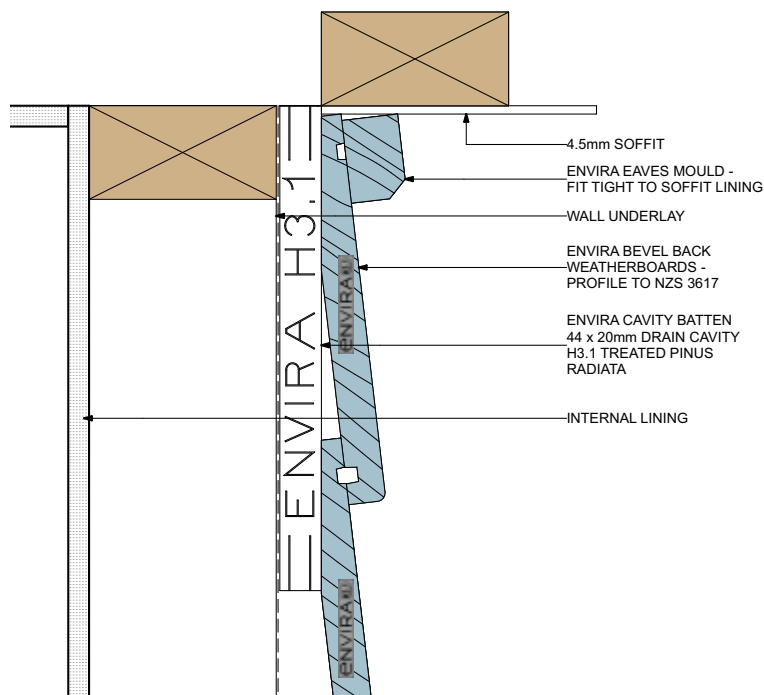

Bevel Back Cavity Fix External Corner

3010 2D :

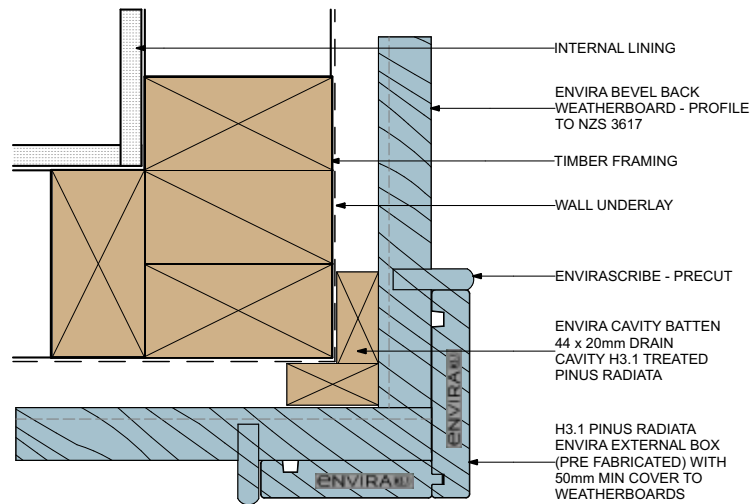

Bevel Back Cavity Fix External Corner Soaker

3010 A 2D :

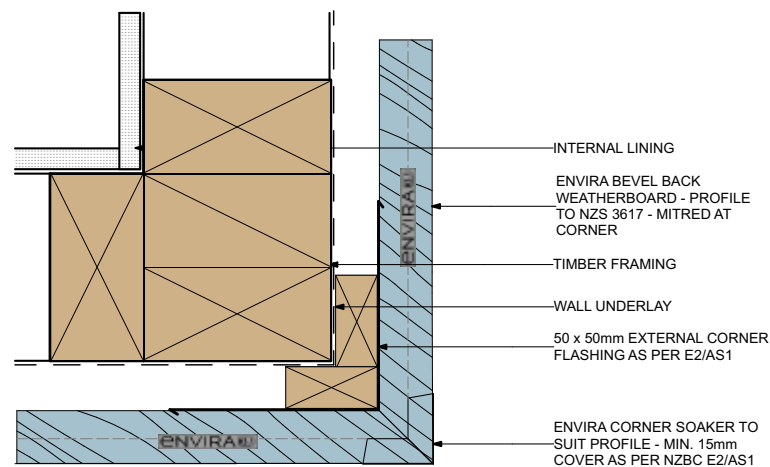
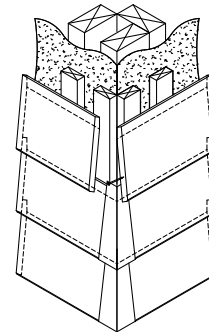

DATE: 16/04/2024 check for updates and download
2D files in PDF, DWG or DXF format at www.niagara.nz

Bevel Back Cavity Fix Internal Corner

3011 2D :

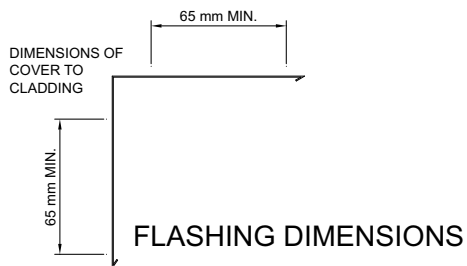
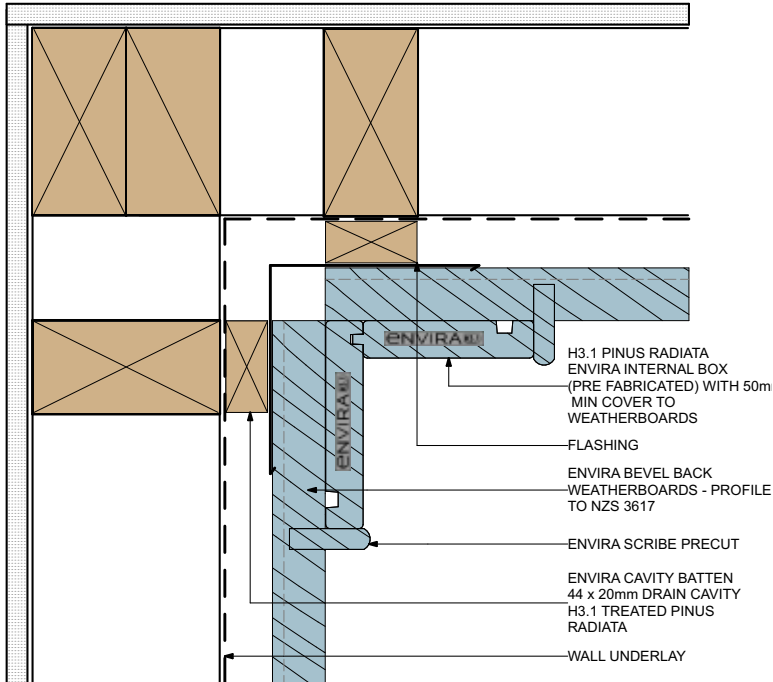

Bevel Back Cavity Fix Meter Box Head

3012 2D :

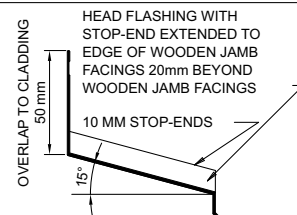
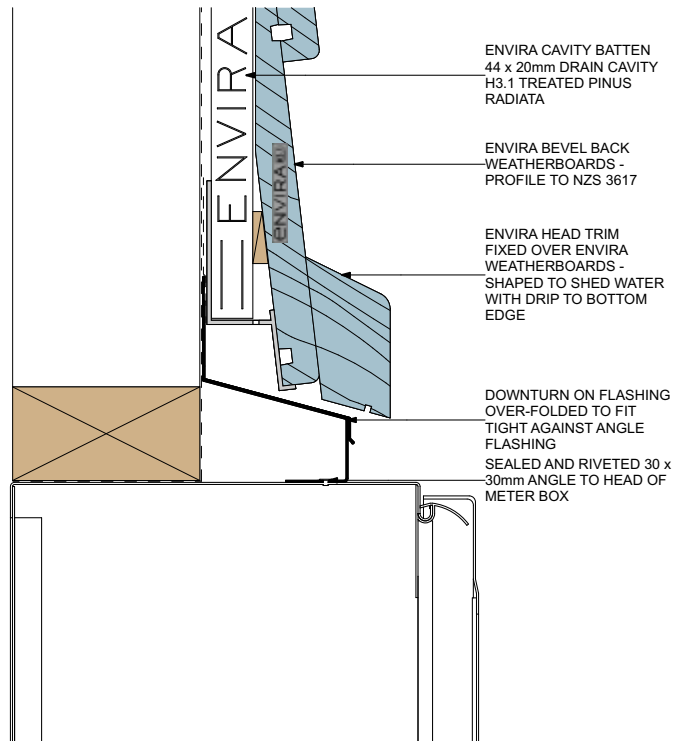

FLASHING DIMENSIONS

Bevel Back Cavity Fix Meter Box Jamb

3013 2D :

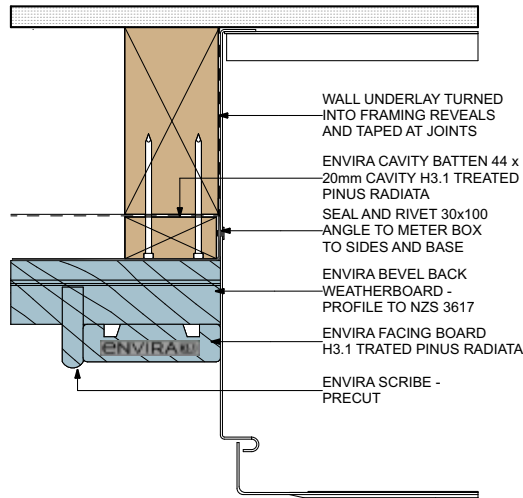

Bevel Back Cavity Fix Meter Box Sill

3014 2D :

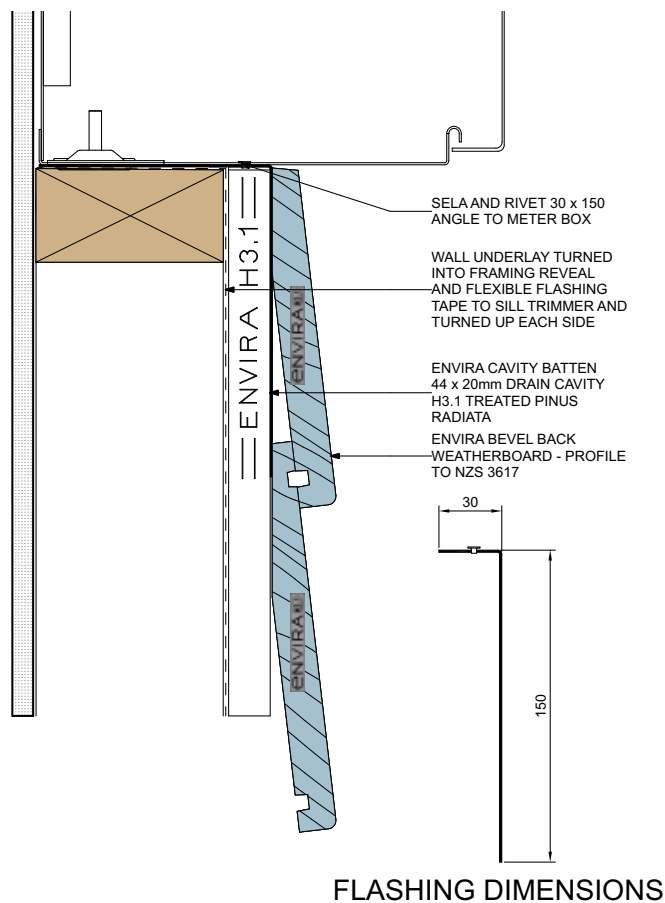

DATE: 16/04/2024 check for updates and download
2D files in PDF, DWG or DXF format at www.niagara.nz

Bevel Back Cavity Fix Pipe Penetration

3015 2D :

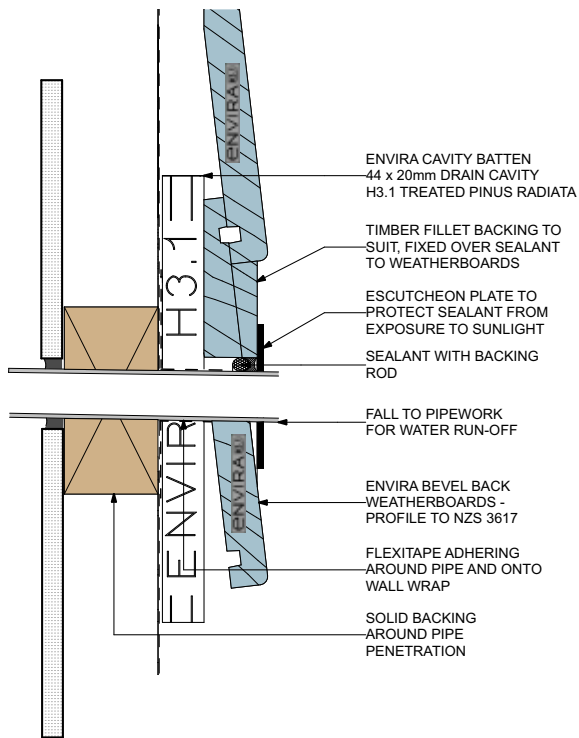

Bevel Back Cavity Fix Fascia Eaves

3016 2D :

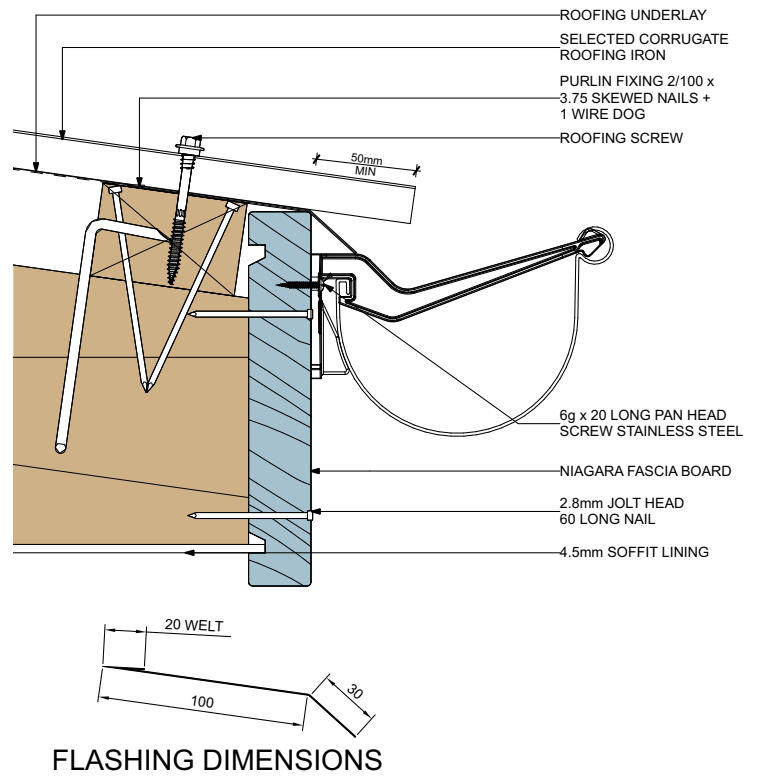

Bevel Back Cavity Fix Apron

3017 2D :

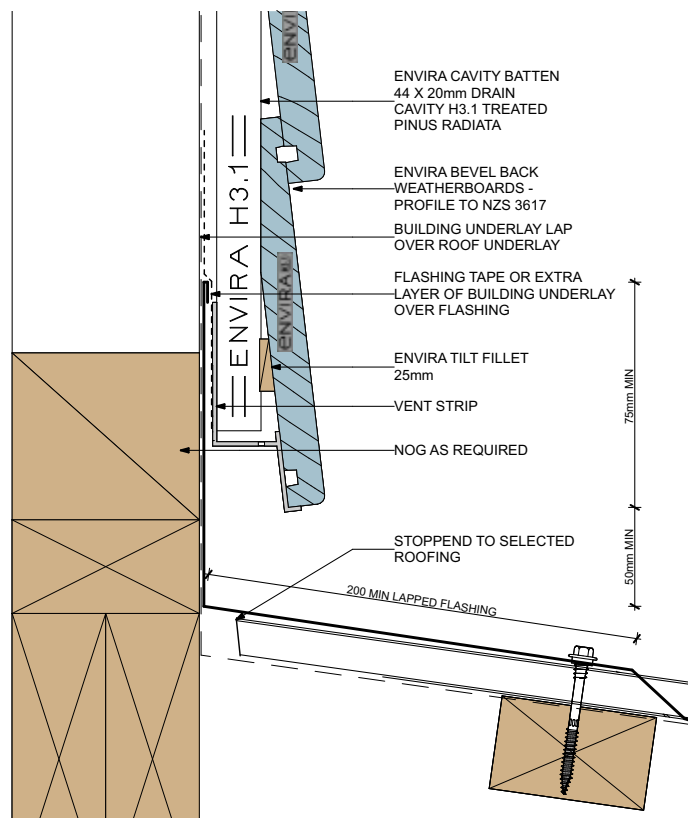

Bevel Back Cavity Fix Parapet Cap

3018 2D :

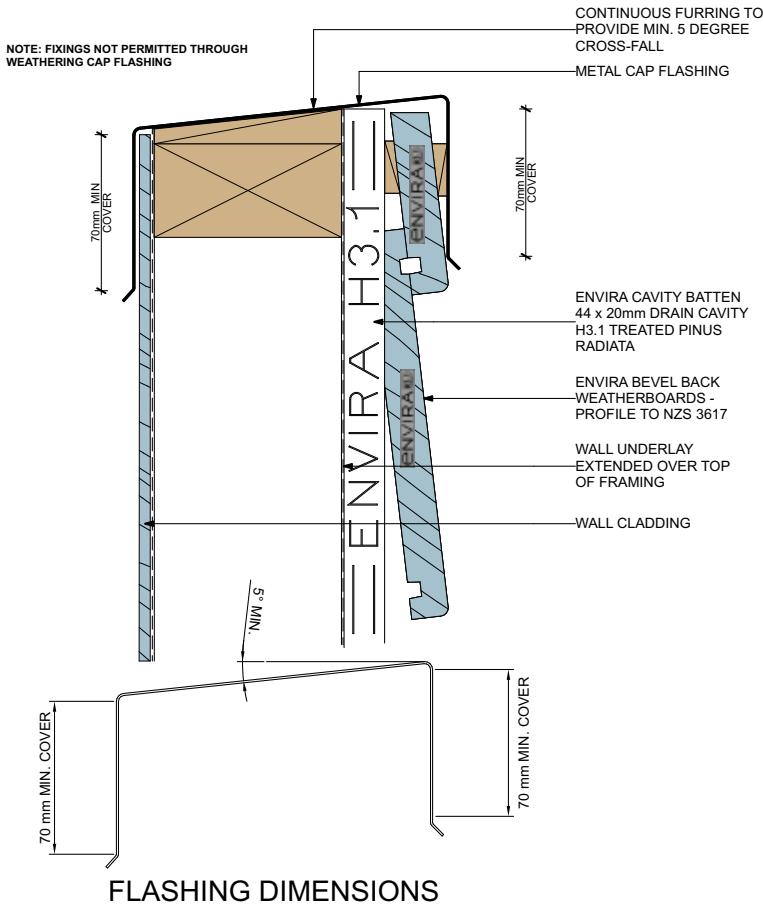

Bevel Back Cavity Fix Stucco - Below

3019 2D :

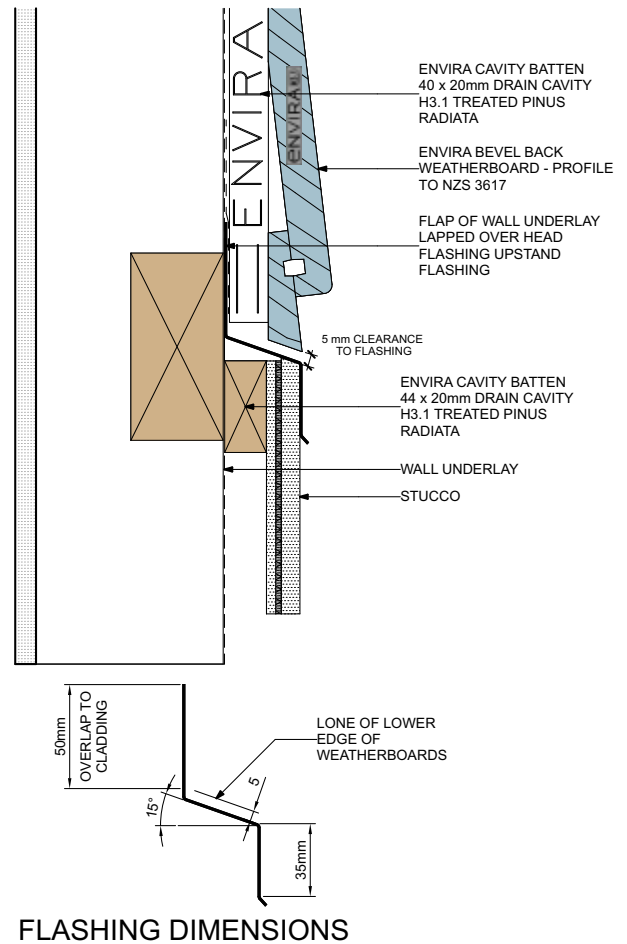

DATE: 16/04/2024 check for updates and download
2D files in PDF, DWG or DXF format at www.niagara.nz

Bevel Back Cavity Fix Stucco - Internal Corner

3020 2D :

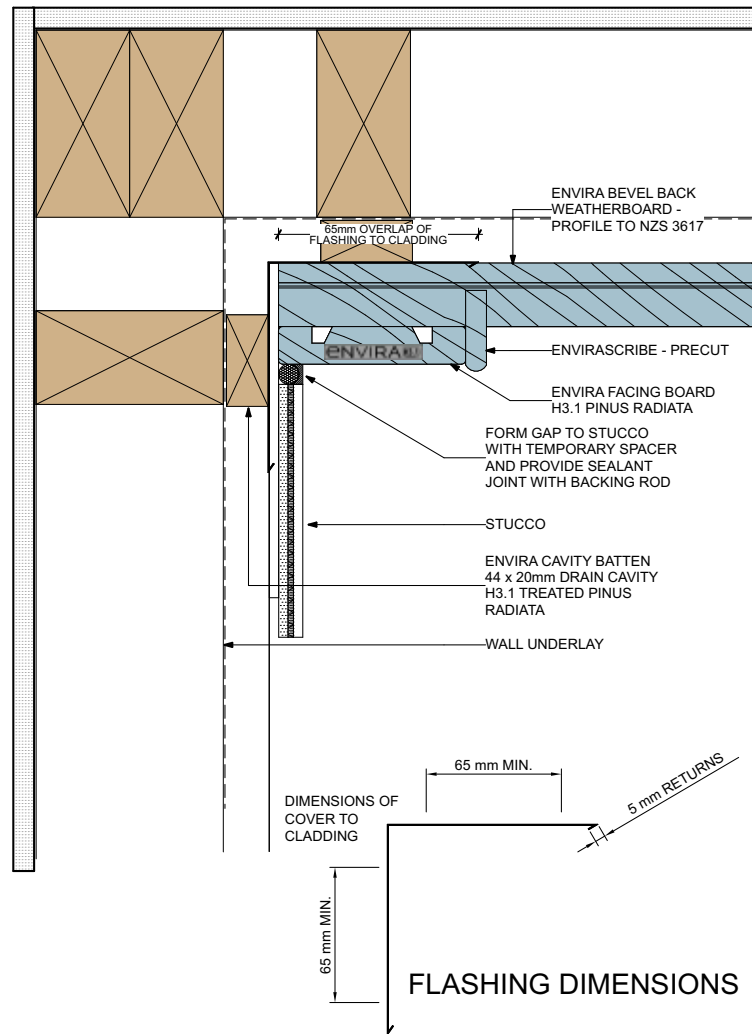

Bevel Back Cavity Fix Stucco - External Corner

3021 2D :

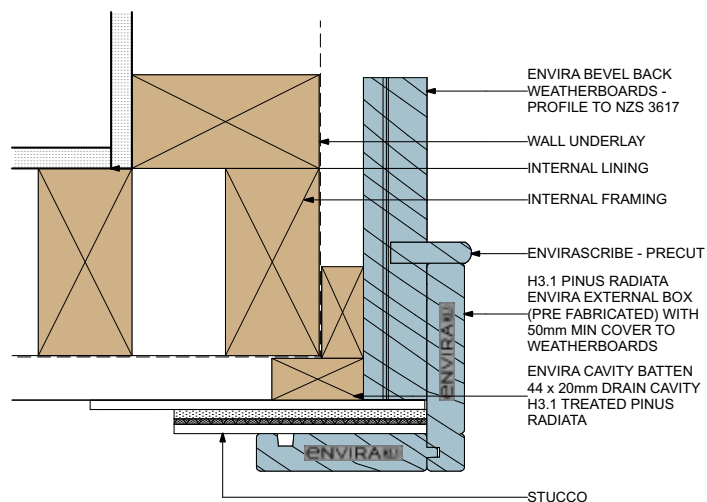

Bevel Back Cavity Fix **Profiled Metal - Above**

3022 2D :

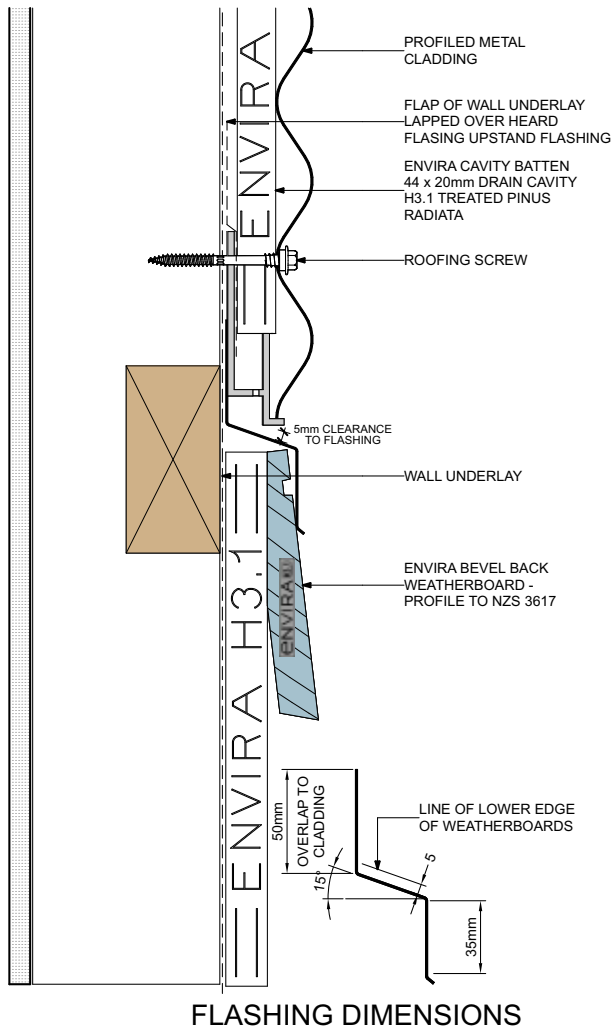

Bevel Back Cavity Fix **Profiled Metal - Below**

3023 2D :

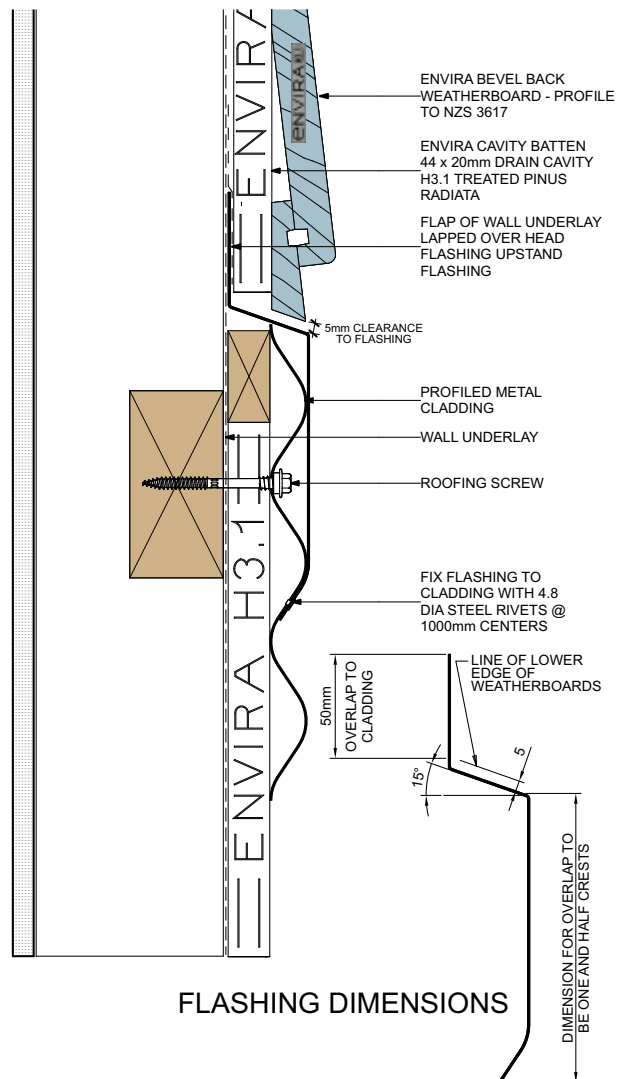

DATE: 16/04/2024 check for updates and download 2D files in PDF, DWG or DXF format at www.niagara.nz

Bevel Back Cavity Fix **Profiled Metal - Abutting**

3024 2D :

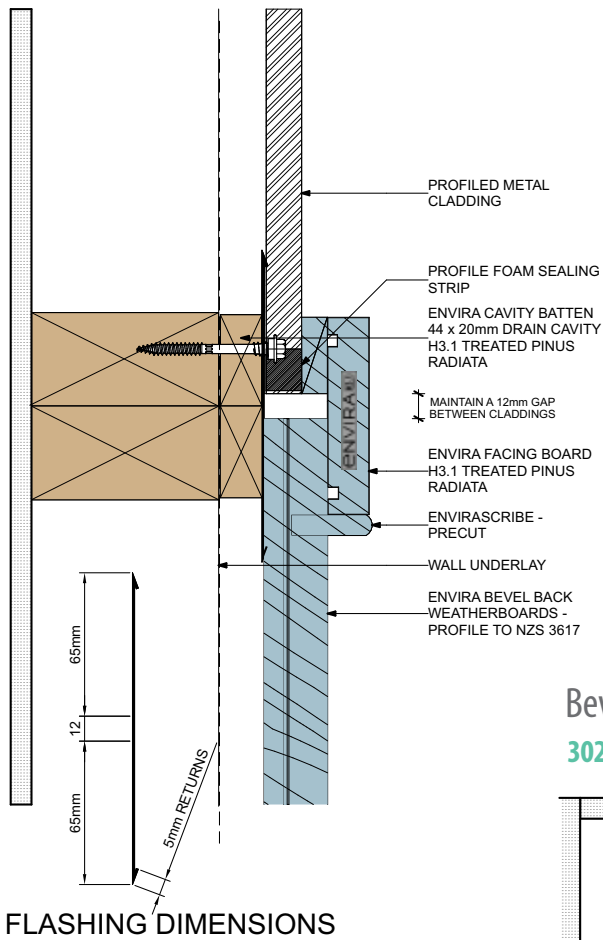

Bevel Back Cavity Fix **Profiled Metal - Internal Corner**

3025 2D :

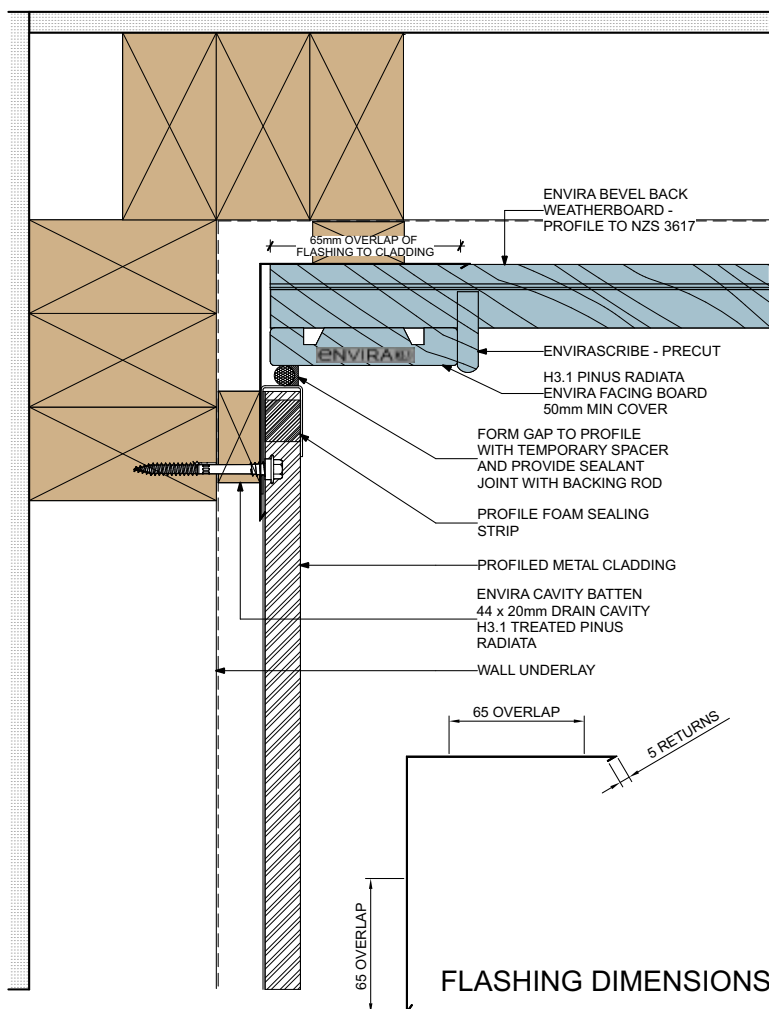

Bevel Back Cavity Fix **Profiled Metal - External Corner**

3026 2D :

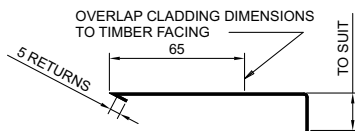
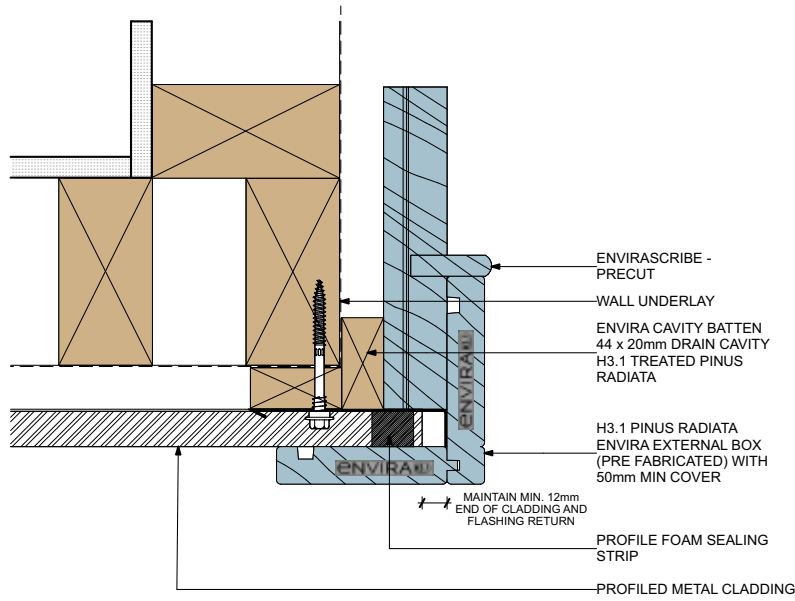

FLASHING DIMENSIONS

Bevel Back Cavity Fix **Masonry Veneer - Below**

3027 2D :

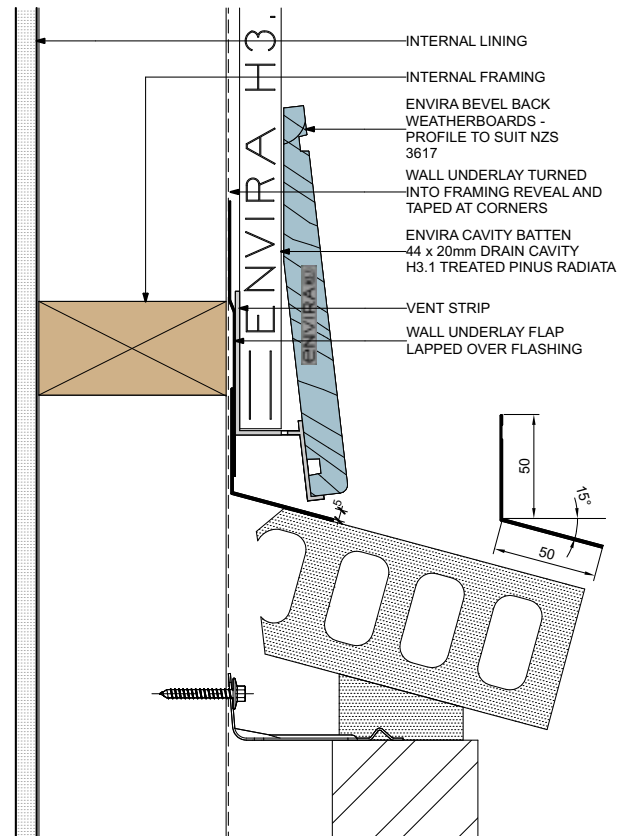

Bevel Back Cavity Fix Masonry Veneer - Abutting

3028 2D :

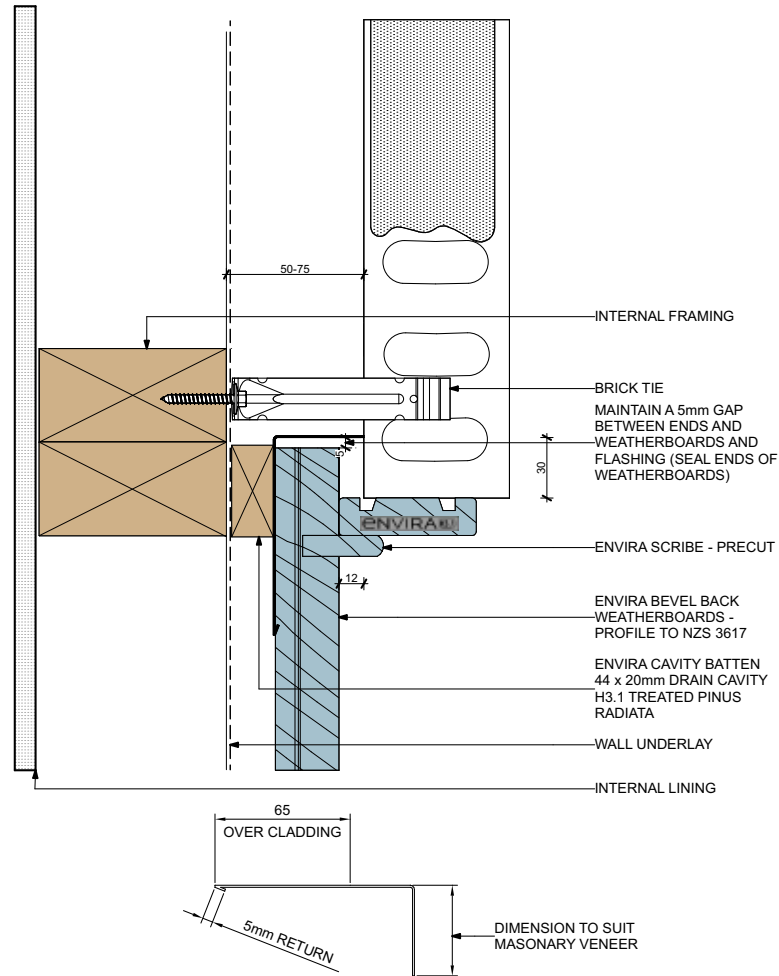

FLASHING DIMENSIONS

Bevel Back Cavity Fix Masonry Veneer - External Corner

3029 2D :

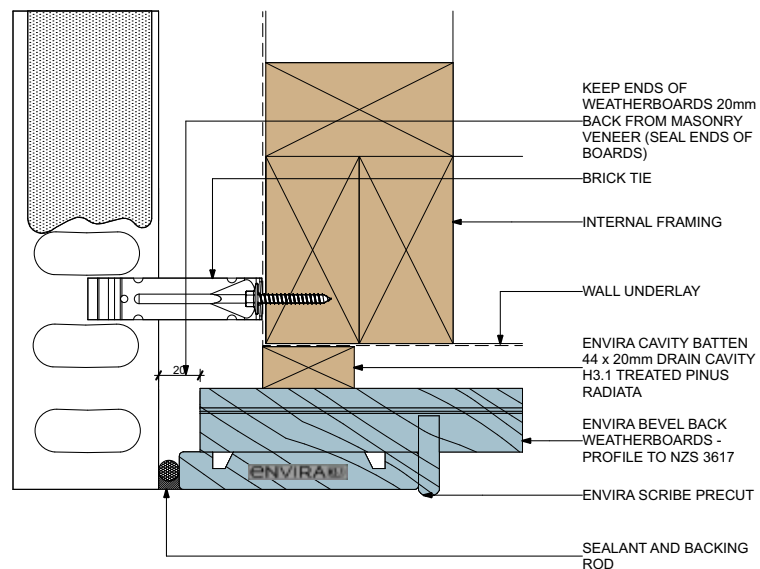

Bevel Back Cavity Fix Masonry Veneer - Internal Corner

3030 2D :

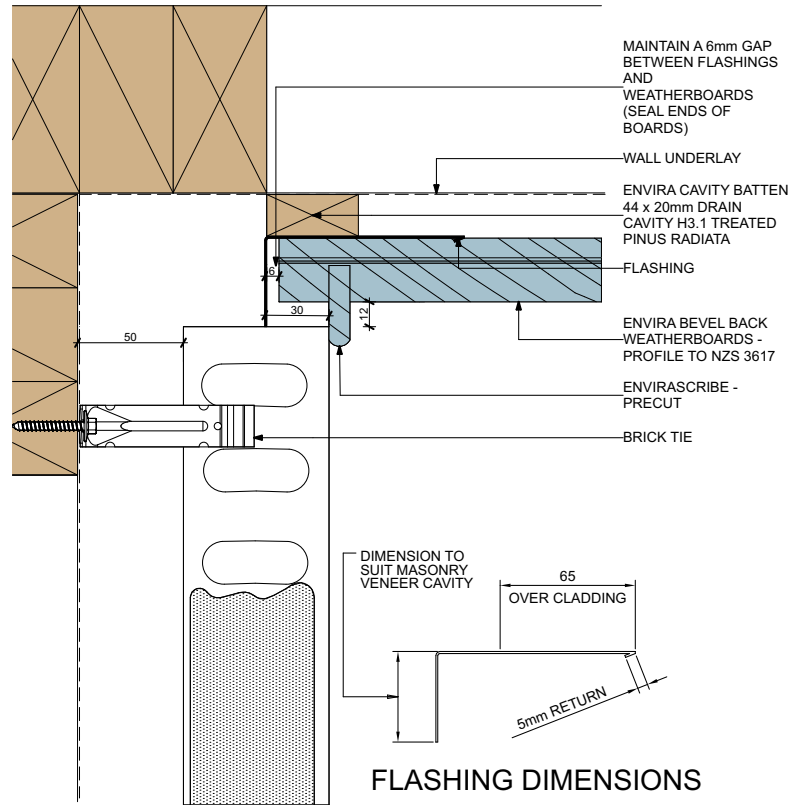

Bevel Back Cavity Fix Above Waterproof Deck

3031 2D :

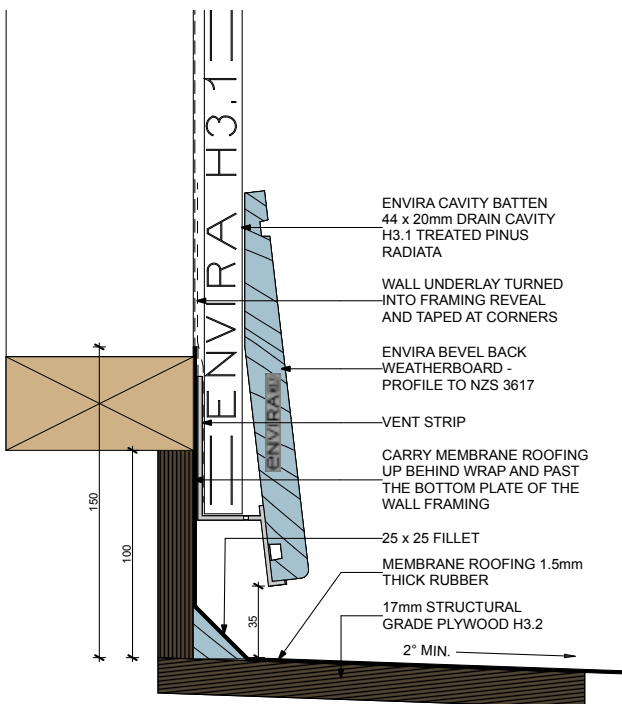

Bevel Back Cavity Fix Mid-Floor Junction

3032 2D :

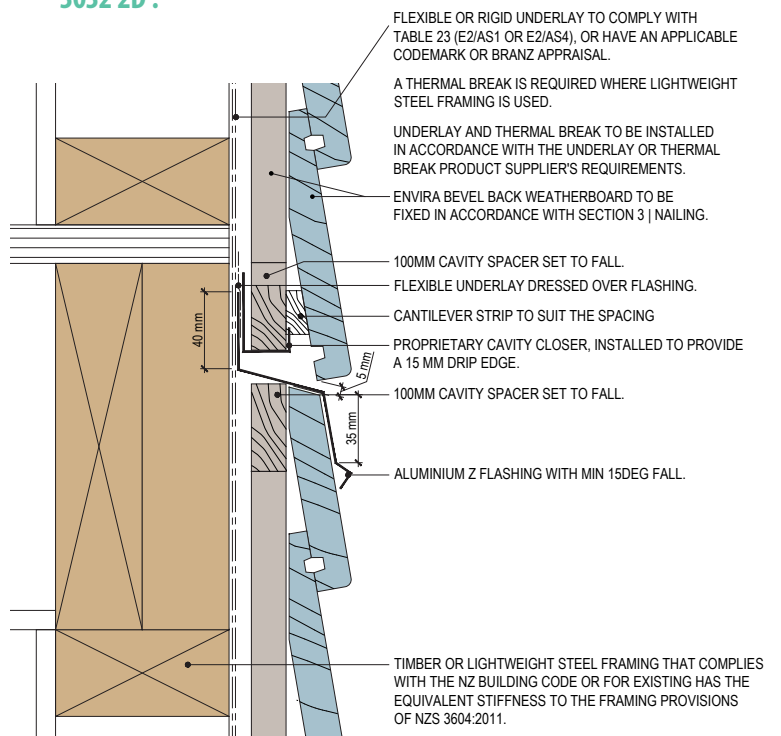

DATE: 16/04/2024 check for updates and download 2D files in PDF, DWG or DXF format at www.niagara.nz

ENVIRA WEATHERBOARD SYSTEM WARRANTY

1. Product Warranty

- 1.1 Niagara Sawmilling Company Limited (Niagara) warrants for a period of 25 years from the date of purchase that its Envira Weatherboard System (Products) will be free from production defects and will be resistant to cracking, rotting and damage from borer attacks, to the extent set out in Niagara's product literature current at the time of installation, subject always to the conditions and limits on liability below (Warranty).
- 1.2 The Envira Weatherboard System Technical Manuals set out the approved and recommended methods for cladding installation. To request a copy of the Envira Weatherboard System Technical Manuals, please phone toll free: 0800 36 78 46 (Monday to Friday 8am – 5pm), or email: sales@niagara.nz, or download online at www.niagara.nz

2. Conditions of Warranty

- 2.1 The Warranty is strictly subject to the following conditions:
 - 2.1.1 The Products must be installed by a competent and qualified builder, strictly in accordance with:
 - (a) the Envira Weatherboard System Technical Manuals current at the time of installation, utilising Envira Weatherboard System components or products specified in the Envira Weatherboard System Technical Manuals; and
 - (b) all relevant laws and regulations.Where the Envira Weatherboard System Technical Manuals do not provide suitable detail for installation of the Products then installation must be in accordance with best trade practice determined in consultation with the relevant local or regional council or such other appropriate organisation or authority and the designer of the building works.
 - 2.1.2 The Products must be maintained strictly in accordance with the Envira Weatherboard System Technical Manuals. Further, all other products including coating and jointing systems applied to, or used in conjunction with, the Products must be applied, installed and maintained strictly in accordance with the relevant manufacturer's instructions and best trade practice.
 - 2.1.3 The building works in which the Products have been incorporated must be designed and constructed in strict compliance with all relevant provisions of the current New Zealand Building Code, regulations and standards, and the building consent relating to the building works.
 - 2.1.4 If any remedial work undertaken in relation to the Warranty involves re-coating of the Products, the customer acknowledges and agrees that there may be slight colour differences between the original and replacement Products due to the effects of weathering and variations in materials over time.

3. Limits on Liability

- 3.1 Niagara will not be liable to the customer for any breach of Warranty unless the customer gives Niagara written notice of any claim for breach of Warranty within 30 days of the defect becoming reasonably apparent.
- 3.2 In any event, the customer's sole remedy under the Warranty is (at Niagara's discretion) that Niagara will either supply replacement Products, rectify the affected Products where such Products are capable of rectification, or pay for the reasonable cost of the replacement or rectification of the affected Products.
- 3.3 Aside from the remedy described in clause 3.2, Niagara will not be liable for any other losses or damages (whether direct or indirect) including property damage, personal injury, consequential loss, economic loss or loss of profits, whether arising under statute, contract, tort including negligence, or howsoever arising. Without limiting the foregoing, Niagara will not be liable for any claims, damages or defects arising from, or in any way attributable to:
 - 3.3.1 poor workmanship;
 - 3.3.2 poor design or detailing;
 - 3.3.3 incorrect design of the structure;
 - 3.3.4 settlement or structural movement and/or movement of materials to which the Products are attached;
 - 3.3.5 acts of God including, but not limited to, earthquakes, cyclones, floods or other severe weather conditions or unusual climatic conditions;
 - 3.3.6 efflorescence or performance of paint/coatings applied to the Products;
 - 3.3.7 normal wear and tear; or
 - 3.3.8 growth of mould, mildew, fungi, bacteria, or any organism on the surface of any Products (whether on the exposed or unexposed surfaces).
- 3.4 All warranties, conditions, liabilities and obligations other than those specified in this Warranty are excluded to the fullest extent permitted by law. The Warranty does not exclude or modify any legal rights a customer may have under the Consumer Guarantees Act 1993. Unless otherwise specified in writing at the time of sale, Niagara assumes no liability for the Products being fit for any particular purpose under the Building Act 2004, other legislation or at common law.

ENVIRA[®]

BY NIAGARA



www.niagara.nz

SOUTH ISLAND SALES & DISTRIBUTION

 **0800 36 78 46**  145 Alford Forest Road
 sisales@niagara.nz Ashburton 7700, New Zealand

NORTH ISLAND SALES & DISTRIBUTION

 **0800 36 78 46**  24 - 26 Oliver Street,
 nisales@niagara.nz Cambridge 3434, New Zealand