

VERONA WALL 1200 1 X DRAWER - FRENCH OAK VELVET CURVED
VITREOUS CHINA

ELEMENTI

86809.77

\$1369

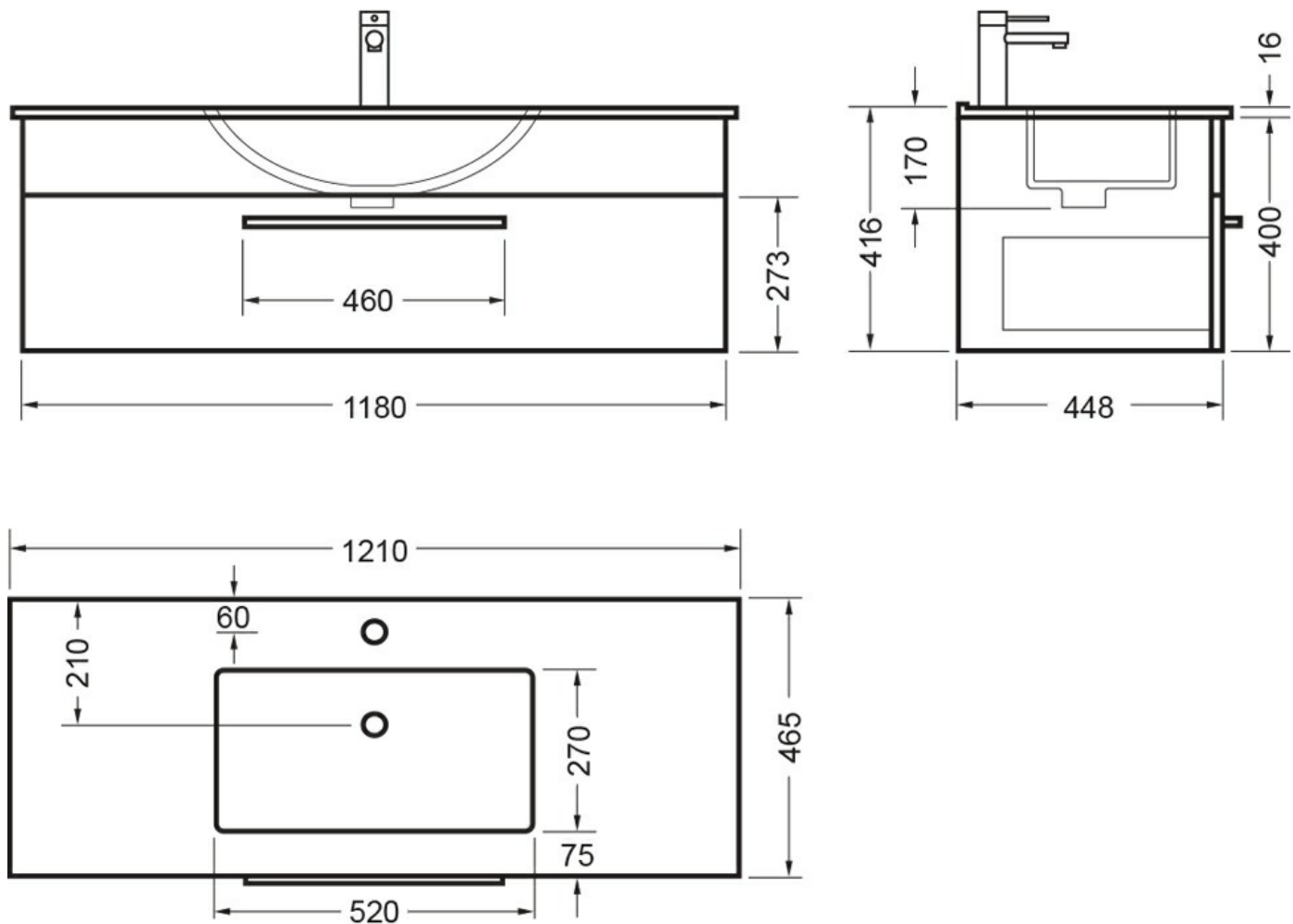

Residential/Light Commercial

Suitable for Residential/Light Commercial Use (Kitchens, Bathrooms and Laundries in Motels, Hotels and Retirement Villages)

5

Guarantee

5 Year Guarantee (Basin & Cabinet)

10

Guarantee

10 Year Guarantee (Tavolo Top)



Hafele Lifetime Warranty

All Hafele Hardware comes with a Lifetime Warranty.



Delivery

Minimum 15 working days



Hettich Guarantee

All Hettich Hardware comes with a Lifetime Warranty.





Moisture Resistant

Made from Moisture Resistant Board



Soft Close Hinges

Incorporates Hettich Soft Close Hinges.



Environmental Choice

Product manufactured predominantly from sustainably grown New Zealand plantation pine forests and is Environmental Choice Certified.



Made in New Zealand

Crisp lines, a clean finish and impressive features are what defines the Verona vanity range.