

# NURAJACK

DECKING MADE EASY



• IMAGE: WATER TREATMENT PLANT TAUPONOZ.



**The ultimate deck pedestal solution.**

[www.nurajack.co.nz](http://www.nurajack.co.nz)

# The ultimate deck pedestal solution

NURAJACKS MAKE IT EASY FOR ALL DECKING REQUIREMENTS



- Creates a level deck surface
- Strong and stable - load tested to over 1000kg
  - Easy to replace tiles
- Durable - warranted for 20 years
- Easy access to waterproofing membrane below
  - Void accommodates services which can be placed under deck surface
    - Acoustic sound barrier
    - Windproof options
- Level indoor-outdoor flow

**With Nurajacks, low profile decks have never been easier... jobs that were once time-consuming and complicated now run smoothly with efficiency & ease.**

**Our patented system means you can trust that your deck will be level and will meet Building Code & Council Standards.**

Nurajacks are height adjustable. They allow the tiles or decking to be raised up to the level of the interior living space. This creates a level threshold with optimum indoor-outdoor flow.

When installing over waterproofing membrane, tiles and decking should be removable to allow access to the membrane below the surface. Your ultimate solution to achieve this is using Nurajacks and Nurapads.

Laying a floor or deck with Nurajacks is easy. The Nurajacks rest on top of the substrate and the tiles or decking timber sit on the self-levelling head of the

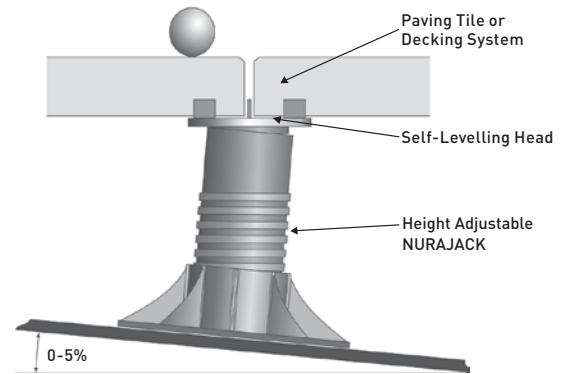

Nurajack. The void between the decking and the substrate can be used to accommodate pipes and other services. The Nurajack system does not use grout or adhesives. When it rains the water flows between the tiles and decking, onto the substrate and then unimpeded onto drainage. The Nurajack system protects waterproof membranes from foot traffic and harsh UV sunlight so that it can keep your home dry.

Adding the Nurajack SE Acoustic Pad is a cost-effective way to enhance the acoustic reduction properties of the system.





## TILE

The Nurajack with self-leveling tile head can support structural tiles, stone and concrete pavers designed for floated applications. An integrated rubber pad minimises the tile or paver vibration which in turn minimises foot fall echo and tile movement. The self-leveling head ensures the tile is not point loaded and the large base of the Nurajack ensures any membrane under the Nurajack is protected.

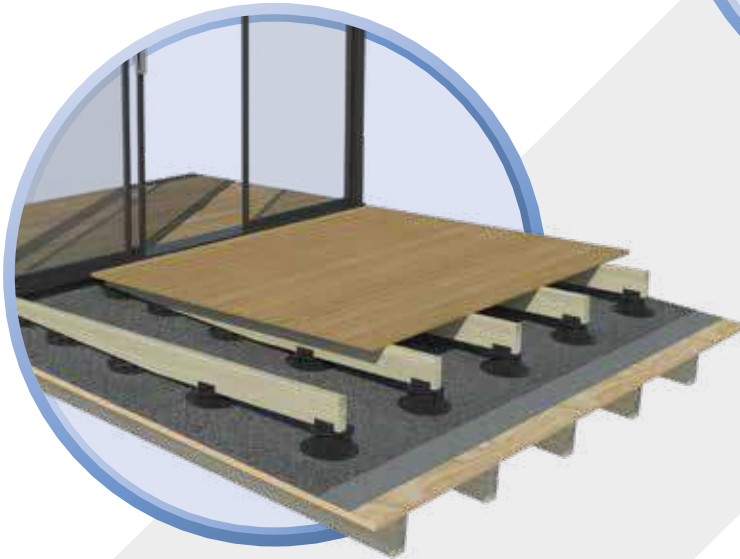
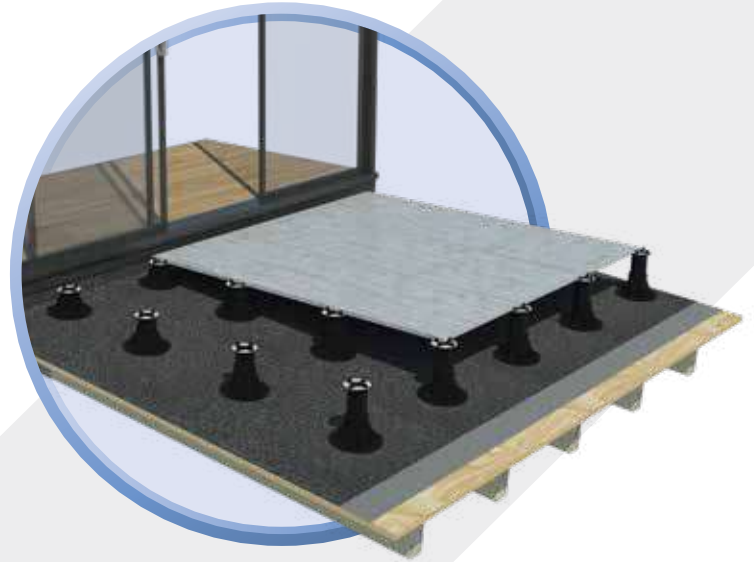

## WOOD

The quickest way to install a timber deck is to use the Nurajack to support the deck structure. Nurajacks can withstand up to 1000kg per jack and can be installed over any stable non-eroding surface. Perfect for creating level entries and indoor/outdoor flow with ease.







## UNIQUE FEATURES & BENEFITS

- Easily creates a level deck surface with the patented Self-Levelling head
- Strong & stable - Load tested to withstand loads up to 1000kg
- Easy Height-Adjustment Feature with Nurajack Adjustment Key
- Easy to replace tiles & timber decking
- Durable - 20 year warranty
- Easy access to water-proofing membrane below
- Sizes from 8mm to 550mm
- Void accommodates services which can be placed under deck surface
- Increases the acoustic performance - foot fall noise is minimised from traveling to the inside of the building
- Windproof options available
- Level indoor-outdoor flow
- Meets Building Code requirements
- Made in Italy - designed & manufactured to the highest standards & quality.



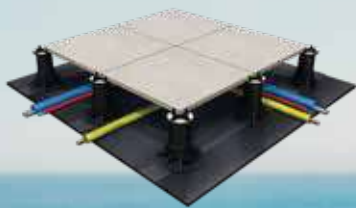
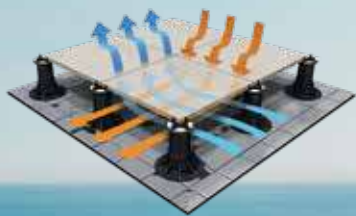



**STAR.T**  
8-15mm

### Nurajack Star.T

The smallest Nurajack is the Nurajack Star.T. Starting at a height of 8mm, The Nurajack Star.T can be adjusted up to 15mm. The Nurajack Star.T is leveled using a Nurajack Star.T Slope Corrector. It may be that the installer is satisfied with the tiles following the fall of the membrane, in which case no leveling of the Nurajack Star.T is required.



**STAR.B**  
5mm

### Nurajack Star.B

The Nurajack Star.B is a 5mm base for the Nurajack Star.T. The Nurajack Star.B bases can be stacked under the Nurajack Star.T up to 3 high, giving the Nurajack Star.T and Star.B combination an adjustable size of between 8mm to 30mm.



**SHIM 1,2,3.**

### Shim

The Nurapad Shim is designed for use with the Nurapad and Nurajack. The Shim can be used to accommodate any variance in thickness of pavers or tiles. They can also be used to level a Nurapad or Nurajack Star.T if necessary.



**NURAJACK  
HEAD LOCKER**

### Nurajack Head Locker

When installing smaller cut tiles adjacent to full tiles, it may be necessary to lock the self-leveling head to stop excessive movement. The Nurajack Head Locker is designed to clip into place and lock the Nurajack's self-leveling head.



**ADJUSTMENT  
KEY**

### Tilehead Adjustment Key

Nurajacks can be adjusted by the Nurajack Adjustment Key even without the tiles being uplifted. The Nurajack Adjustment Key simply slips between the tiles and into a slot in the top of the Nurajack or Nurajack Star.T and when turned the Nurajack will adjust up and down. The Nurajack Adjustment Key speeds up installation and is ideal for minor adjustments. If installing heavy stone or concrete pavers, one or two pavers may need to be lifted before adjusting the Nurajack.



**ACOUSTIC  
SEPARATION PAD  
3mm**

### Nurajack Acoustic Separation Pad

Footfall noise on any deck area can be minimised through using the Nurajack Acoustic Separation Pad. The Nurajack Acoustic Separation Pad is a self-adhesive disc that adheres to the base of the Nurajack. It will provide a Nurajack SE3 with a total of 25dB (IIC:25) reduction in acoustic transference noise. Acoustic Separation Pads can also be used as a slip layer between a Nurajack and an incompatible membrane.



**NURAJACK  
SE WINDPROOF**

### Nurajack SE Windproof

In some extreme situations, tiles may need to be affixed to the Nurajack. The Nurajack SE Windproof is a pedestal especially designed for areas in direct exposure to high winds. When parapets and balustrades do not provide enough protection, the Nurajack SE Windproof pedestal provides the solution.





**TILE CLADDING SPACER**

### Tile Cladding Spacer

Under the building code a space must be maintained between the installed tiles and the wall, cladding, joinery or balustrade. Nuralite's Tile Cladding Spacers are a self-adhesive rubber bumper available in 5mm, 10mm and 14mm sizes and maintain the space required. Each Tile Cladding Spacer is slightly compressible and needs to be compressed in place during installation.



**NJMS**

### Nurajack Mini Spacer (NJMS)

The Nurajack Mini Spacer is designed for installing 20mm tiles / structural pavers over compacted base-course and sand. Available in bags of 10.



**NJMS+**

### Nurajack Mini Spacer + Spike(NJMS+)

The Nurajack Mini Spacer + Spike is designed for installing 20mm tiles / structural pavers over grass. Available in bags of 10.



**NURAJACK VERTICAL CLIP**

### Nurajack Vertical Clip

The Nurajack Vertical Clip will hold 20mm tiles in place vertically under a leading edge of a Nurajack. This is sometimes required when the edge of a deck is exposed or the underside of the deck can be seen through a glass balustrade.



### Nurajack Acoustic Separation Pad

SEE SAME DETAIL AS TILE ACCESSORY OPPOSITE.

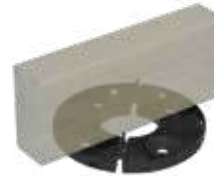

### Nurapad 12mm Low Profile Deck Pedestal

Where there is not enough room for a joist and a Nurajack, a Nurapad can be used. Nurapads are designed to sit under a timber or aluminum joist. Nurapads can accommodate timber joists up to 50mm thick and do not need to be affixed to the joist - the joist will key into the top of the Nurapad. Nurapads can be used as a cradle to support a tapered joist to create a level deck surface or until there is enough space for a Nurajack SE.

### KEY BENEFITS OF NURAPADS:

- 12mm tall polypropylene plastic disk with upright plastic tabs for the spacing of timber joists (or tiles).
- Large pad to evenly distribute the weight of the deck.
- Nurapads can be stacked on top of each other or rubber shims are available to adjust for height.
- Each Nurapad can be separated into quarters to facilitate installation near corners & other obstructions.
- MADE IN ITALY to the highest standards.



## SPEC DRAWING FOR TILE DECKS

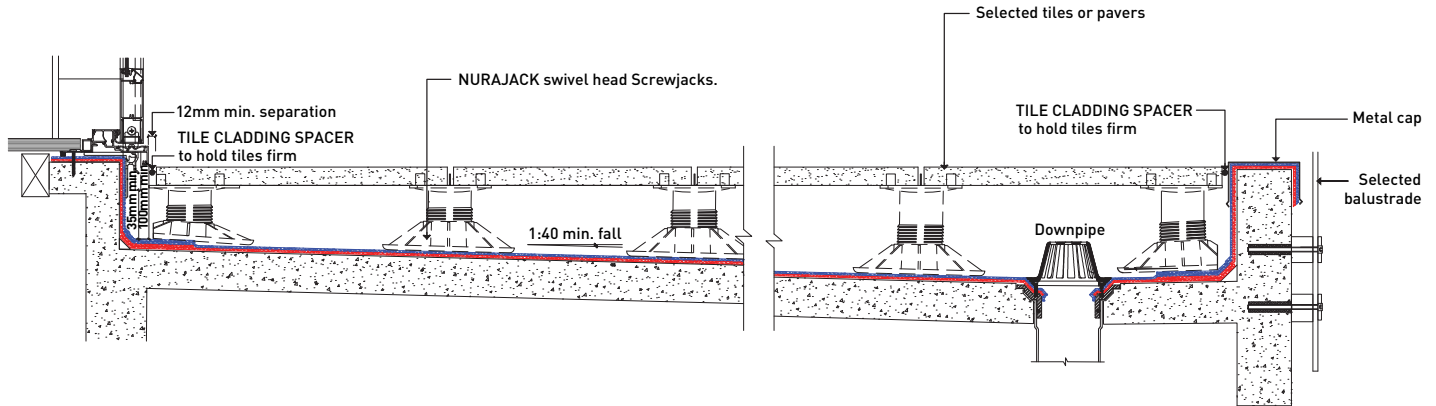

## TECHNICAL INFORMATION &amp; INSTALLATION REQUIREMENTS

**Warranty**

Nurajacks are covered by a full 20-Year Warranty.

**Specify Nuraply 3PM Waterproofing Membrane with Nurajacks**

For a high-performance, fully warranted system, specify Nuraply 3PM waterproofing membrane with Nurajacks to support tiles, pavers or decking. Nuralite offers a 20-Year material performance warranty on all products installed as part of the complete system.

**System Compatibility is Important**

If you are intending to install Nurajacks over an alternative waterproofing system please check with the supplier beforehand to ensure all products on the deck are compatible.

**Structural Tiles are a Must**

A structural tile or paver must be used with the Nurajack system. Before purchasing your tile or paver check that it is strong enough to carry foot traffic weight when supported by Nurajacks. You will need to get the supplier to warrant it will work with the Nurajack system. It is the tile/paving suppliers responsibility to specify the quantity of Nurajacks required to support each tile/paver.

**Prior to Installation**

The waterproofing membrane must be clean and clear of foreign objects before installing Nurajacks.

**Strength**

Nurajacks are made from high-density polypropylene injection moulding. Their strength is demonstrated by their ability to take a maximum loading of 1000kg per Nurajack. If heavy loads are anticipated this must be considered when specifying and designing the waterproofing system. Be aware that the Nurajack system is not designed to support moving vehicles such as cars or scissor lifts.

Download your detailed instructions  
on the use of Nurajacks and the  
installation at  
[www.nurajack.co.nz](http://www.nurajack.co.nz)

## SPEC DRAWING FOR TIMBER DECKS

Use a combination of Nurapads and Nurajacks.

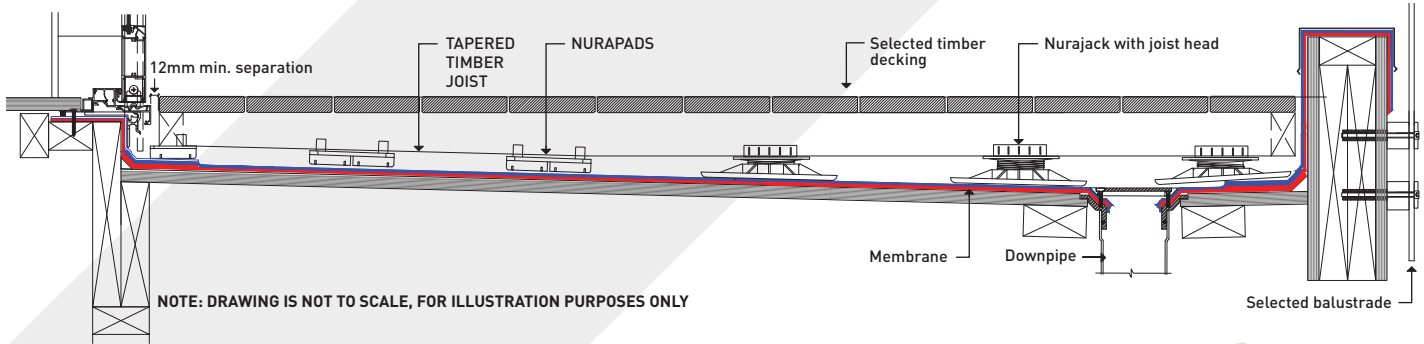

### NURAJACK PLACEMENT FOR TIMBER DECKS

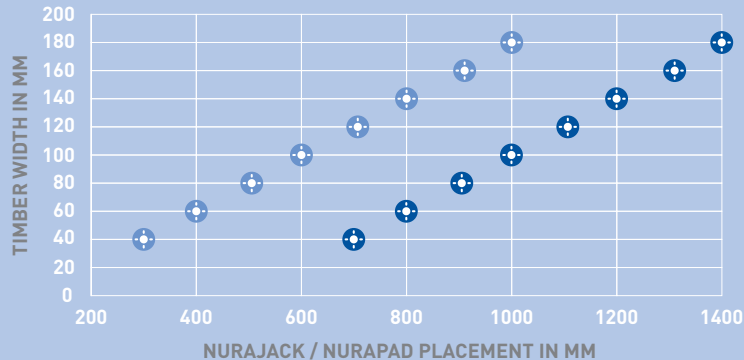

Over membrane decks

Over other surfaces (incl. Nuraspikes)

# NURAJACKS MAKE IT EASY FOR ALL DECKING REQUIREMENTS

**INSTALLATION VIDEOS:** See our website for training videos



## SIZES AVAILABLE:

Sizes are available for both tile and timber decks from 8mm to 550mm.



More information including installation videos  
& quantity calculators are available at  
[www.nurajack.co.nz](http://www.nurajack.co.nz)



\*10/2019. PRODUCTS & SPECIFICATIONS SUBJECT TO CHANGE



PROUDLY DISTRIBUTED BY: NURALITE - THE FLAT ROOFING EXPERTS  
60D Leon Leicester Ave, Mt Wellington, Auckland, NEW ZEALAND  
P 09 579 2046 F 09 579 5136 E info@nurajack.co.nz

