

BUTELINE PLUMBING SYSTEM

Plumbers Technical & Installation Manual

The Complete Plumbing System



WaterMark
AS/NZS 2642
Lic: WM 1640



Quality
ISO 9001

SureFit
EasyID



0800 BUTELINE
www.buteline.com



Contents

Buteline and Our Commitment	1
The Buteline Plumbing System	2
Why Plumbers Use the Buteline Plumbing System	3
Green, Sustainable Plumbing	4
Buteline PB-1 Plumbing System - 15mm, 20mm & 28mm Range	5
Buteline PB-1 Plumbing System - 12mm Range	12
Buteline Fittings	14
Buteline Polybutene-1 Pipe	15
Buteline Clamp Tools	16
How To Check Your FR Clamp Tool	17
Installation Demo for FR Non-Adjustable Tools	18
Installation Demo for ProClamp, QuickClamp & 28mm Clamp Tools	19
Adjustment Instructions for ProClamp Tools	20
Adjustment Instructions for 28mm Clamp Tool	21
Installation Guide	22
Use Only the Complete Buteline System	26
Storage and Handling	27
Feeding Buteline PB-1 Pipe Through Timbers	28
Bending Radius	29
Pipe Clipping	30
Buteline Polymer Threaded Connections	31
Swivel Connections	31
Connecting to Brazing Tails (Alternative Copper Connection)	32
Installing Buteline Underground	34
Installing Buteline in Concrete / Masonry / Marine	35
Chlorine & Freezing Conditions	36
UV Exposure, Thermal Conductivity & Fire Information	37
Fire Protection	38
Passive Fire Protection Guide	39
Buteline Internal Bore Sizes	40
Pipe Wall Thickness	40
Working Pressure	41
Pipe Pressure Head Loss for Polybutene-1 Pipe	42
Hot Water Installations	43
Typical High Pressure Hot Water Cylinder	44
Typical Low Pressure Hot Water Cylinder	45
Solar Hot Water & Recirculated Hot Water Systems	46
Is Buteline Suitable for use with Re-circulated Hot Water Systems?	47
Non-Potable Water Piping & Other Uses for Buteline	48
Installation Checklist	49
Bute-1 / Bute-1EX Installation Guide	50
Installation Guides for Telescopic Nog Brackets	54
Typical Method of Plumbing	56
Acceptable Maximum Pipe Lengths (Water Heater to Kitchen Tap)	58
Definition of Terms	59
Project References	61
Pressure Conversion Chart	64
The Buteline 25 Year Warranty	65

Buteline And Our Commitment

The Buteline Professional Polybutene-1 (PB-1) Plumbing System has won world acclaim for innovation and advanced design. To this day, Buteline's commitment to excellence continues to be evident with the products shipped from our headquarters in Auckland, New Zealand since 1980.

Buteline is proud to be a **New Zealand owned and operated** company.

Buteline also source quality components from verified overseas suppliers to supplement our system.

Buteline has installed in-house test equipment to give both quality assurance and quality control of production. These facilities combined with a strong commitment to continuing research and development will ensure that Buteline remain leaders in PB-1 plumbing technology. Our engineers and technical team thrive on the challenges presented with future product development.

The Buteline Plumbing System complies with the Australian and New Zealand joint standards AS/NZS 2642, Watermark, AS/NZS 4130, AS/NZS 4020, and is covered by extensive worldwide patents.



For a free guided tour of Buteline's manufacturing plant in East Tamaki, Auckland, please freephone 0800 BUTELINE.

The Buteline Plumbing System

Buteline has developed a total solution to the need for a safe, integrated and easy to use potable water plumbing system. The resultant PB-1 system is designed specifically for professional plumbers and has proven to be high quality and economical.

It is strongly recommended that tradesmen use Buteline's total system, i.e. Buteline clamp tools, Buteline PB-1 pipe and clips, and Buteline fittings, to ensure total compatibility of installations.

When installed in accordance with recommendations contained herein, the complete system is fully guaranteed by Buteline (see page 65).



Why Plumbers Use The Buteline Plumbing System

- ✓ The Buteline PB-1 System is made in New Zealand and is readily available from leading Plumbing Merchants.
- ✓ The Buteline PB-1 System has been designed specifically for use by tradesmen, and meets the requirements of AS/NZS 2642.
- ✓ The Buteline Plumbing System can be installed with no connection to metals using our unique range of polymer fitting solutions.
- ✓ Buteline fittings have a one-piece design concept, incorporating factory fitted clamp rings which ensures high productivity, while providing the strongest reinforced joint available.
- ✓ Buteline fittings are light-weight and easy to transport, with no additional parts such as o-rings, grab rings and pipe inserts.
- ✓ Buteline pipe is one of the most flexible in the market, eliminating water hammer noise. In addition, pipe flexibility = less fittings required.
- ✓ Buteline clamp tools have been designed and engineered for ease of use, to give long life and a professional result every time.
- ✓ The team at Buteline NZ Ltd are readily available to assist you with the best customer service when and where required.



Green, Sustainable Plumbing

- ✓ Buteline polymer fittings are lightweight, from raw material to finished product = Reduced fuel use and less pollution = Low carbon footprint
- ✓ Durability of at least 50 years = Sustainable
- ✓ Recyclable materials = Less wastage
- ✓ Hygienic, non-toxic and safe
- ✓ Less energy required to manufacture polymers than for competing materials such as brass and copper

Amount of energy required to manufacture 1 litre of material

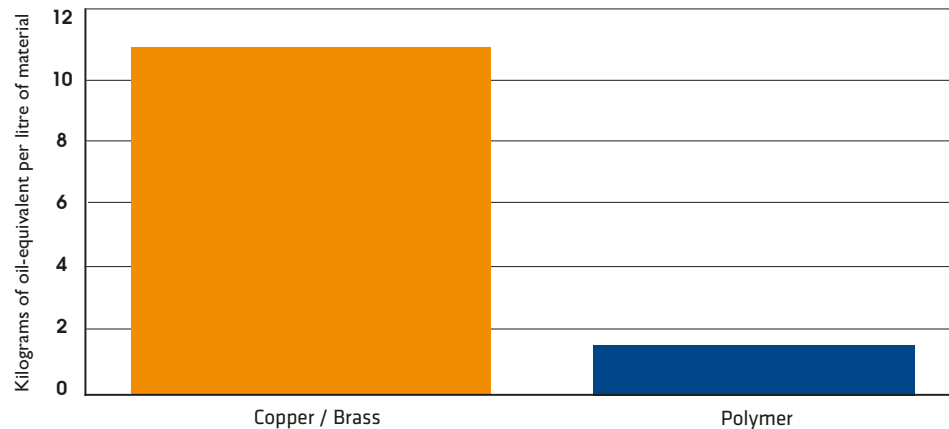

Buteline PB-1 Plumbing System - 15mm, 20mm & 28mm Range



EQUAL TEES

T15 - 15mm x 15mm x 15mm
T20 - 20mm x 20mm x 20mm
T28 - 28mm x 28mm x 28mm



REDUCING TEES

TR112 - 15mm x 15mm x 20mm
TR211 - 20mm x 15mm x 15mm
TR212 - 20mm x 15mm x 20mm
TR221 - 20mm x 20mm x 15mm
TR882 - 28mm x 28mm x 20mm
TR822 - 28mm x 20mm x 20mm
TR828 - 28mm x 20mm x 28mm
TR881 - 28mm x 28mm x 15mm



BRASS IN LINE COPPER TO PB PIPE TEE

TC15B - 1/2" BSP x 1/2" BSP x 15mm to fit 15mm copper



BRASS PB PIPE TO COPPER TEE

TK15B - 15mm x 15mm x 1/2" BSP



EQUAL CROSSES

CX40 - All 15mm
CX48 - All 20mm



REDUCING CROSSES

CX42 - 20mm x 20mm x 20mm x 15mm
CX44 - 20mm x 15mm x 20mm x 15mm
CX46 - 20mm x 15mm x 15mm x 15mm



FEMALE SWIVELS

F15 - 1/2" BSP x 15mm
F20 - 3/4" BSP x 20mm
F2015 - 3/4" BSP x 15mm

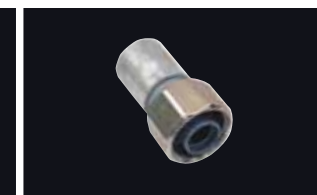

CHROMED FEMALE SWIVEL

F15C - 1/2" BSP x 15mm



BRASS FEMALE SWIVELS

F15BX - 1/2" BSP x 15mm
F20BX - 3/4" BSP x 20mm
F2015BX - 3/4" BSP x 15mm
F2028B - 3/4" BSP x 28mm
F28B - 1" BSP x 28mm

Buteline PB-1 Plumbing System



BRASS FIXED / FEMALE SWIVEL STRAIGHTS
FFS1 - Fixed 1/2" BSP x 1/2" BSP Female
FFS2 - Fixed 3/4" BSP x 3/4" BSP Female

BRASS FEMALE / FEMALE SWIVEL STRAIGHT
FDFS1 - Female 1/2" BSP x 1/2" BSP Female
FDFS2 - Female 3/4" BSP x 3/4" BSP Female

BRASS MALE / FEMALE SWIVEL STRAIGHTS
MFS1 - Male 1/2" BSP x 1/2" BSP Female
MFS2 - Male 3/4" BSP x 3/4" BSP Female



FIXED FEMALES
FF15B - 1/2" BSP x 15mm
FF20B - 3/4" BSP x 20mm

INLINE COUPLINGS
S15 - 15mm x 15mm
S20 - 20mm x 20mm
S28 - 28mm x 28mm

REDUCING COUPLINGS
S2015 - 20mm x 15mm
S2820 - 28mm x 20mm



MALE ADAPTORS
M15 - 1/2" BSPT x 15mm
M20 - 3/4" BSPT x 20mm
M2015 - 3/4" BSPT x 15mm

BRASS LUGGED MALE ADAPTOR
ML15B - 1/2" BSP x 15mm

MALE ADAPTOR
M20C - 3/4" BSPT x 20mm to fit 20mm copper

BRASS MALE ADAPTORS
M15B - 1/2" BSP x 15mm
M20B - 3/4" BSP x 20mm
M2028B - 3/4" BSP x 28mm
M28B - 1" BSP x 28mm

15mm, 20mm & 28mm Range



FEMALE BRAZING TAILS
BTF15 - 15mm
BTF20 - 20mm

For when brazing to copper.

EQUAL ELBOWS
E15 - 15mm x 15mm
E20 - 20mm x 20mm
E28 - 28mm x 28mm

45° ELBOWS
E4515 - 15mm x 15mm
E4520 - 20mm x 20mm
E4528 - 28mm x 28mm

REDUCING ELBOWS
E2015 - 20mm x 15mm
E2820 - 28mm x 20mm

45 DEGREE FEMALE SWIVEL ELBOWS
FE4515 - 1/2" BSP x 15mm
FE4520 - 3/4" BSP x 20mm
FE4528 - 1" BSP x 28mm



FEMALE SWIVEL ELBOWS
FE15 - 1/2" BSP x 15mm
FE20 - 3/4" BSP x 20mm

CHROMED FEMALE SWIVEL ELBOW
FE15C - 1/2" BSP x 15mm

BRASS FEMALE SWIVEL ELBOWS
FE15BX - 1/2" BSP x 15mm
FE20BX - 3/4" BSP x 20mm
FE2028B - 3/4" BSP x 28mm
FE28B - 1" BSP x 28mm



FIXED FEMALE ELBOW
FFE15B - 1/2" BSP x 15mm

MALE ELBOW
ME15 - 1/2" BSPT x 15mm

BRASS MALE ELBOWS
ME15B - 1/2" BSP x 15mm
ME2028B - 3/4" BSP x 28mm
ME28B - 1" BSP x 28mm

Buteline PB-1 Plumbing System



BRASS MALE/FEMALE SWIVEL ELBOW (CHROMED)
MFE1C - Male 1/2" BSP
x Female 1/2" BSP



BRASS MALE/FEMALE SWIVEL ELBOW
MFE2 - Male 3/4" BSP
x Female 3/4" BSP



M&F WHITE FINISHING EXT ELBOW
BMF60 - Male 1/2" BSP
x Female 1/2" BSP



HOSE PLATES
HP15 - 1/2" BSP x 15mm
HP22 - 3/4" BSP x 20mm

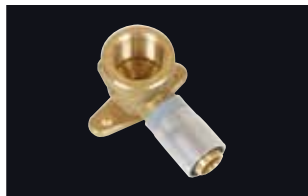

FEMALE WING BACK ELBOWS
WE15 - 1/2" BSP x 15mm
WE20 - 3/4" BSP x 20mm
WE2015 - 3/4" BSP x 15mm
WE28 - 1" BSP x 28mm



DOUBLE FIX FEMALE WING BACK ELBOW
WED15 - 1/2" BSP x 15mm

TOP FIX FEMALE WING BACK ELBOWS
WET15 - 1/2" BSP x 15mm
WET20 - 3/4" BSP x 20mm



MALE WING BACK ELBOWS
WM15 - 1/2" BSP x 15mm x 70mm
WM100 - 1/2" BSP x 15mm x 100mm



TOP FIX MALE WING BACK ELBOWS
WMT215 - 1/2" BSP x 15mm x 200mm
WMT220 - 3/4" BSP x 20mm x 200mm



LUGGED ELBOWS
BLE70 - 1/2" BSPT x 15mm x 70mm
BLE100 - 1/2" BSPT x 15mm x 100mm
Includes test cap and spanner.

15mm, 20mm & 28mm Range



BUTE-1
Adjustable 1/2" BSP Male Wall Elbow
BUTE1 - 1/2" BSP x 15mm x 70mm
BUTE1EX - 1/2" BSP x 15mm x 100mm
Includes telescopic steel brackets, test caps (hot & cold) and palm spanner.



BUTE-1 TELESCOPIC NOG BRACKET
Telescopic galvanized steel bracket supports BUTE-1. Ideal for timber or steel frame projects.
BK2 - 330mm to 610mm



TELESCOPIC NOG BRACKETS
Telescopic galvanized steel bracket supports brass wing backs and polymer Lugged Elbows (BLE's). Ideal for timber or steel frame projects.
BK3 - 260mm to 400mm
BK4 - 355mm to 610mm



FLEXI HOSES
1/2" BSP x 1/2" BSP x 300mm
FPE300 - Elbow Flexi Hose, Bute Nuts
FPS300 - Straight Flexi Hose, Bute Nuts



BRASS RIGHT ANGLE SWIVEL BALL VALVES
RAB15C - 1/2" BSP Female x 1/2" BSP Male (Chrome Plated)
RAB15D - 1/2" BSP Female x 1/2" BSP Male (Matte Black)

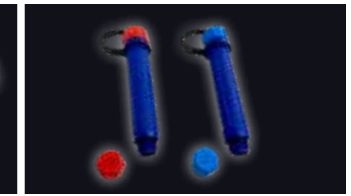

PRO PLUG
PP1520 - 1/2" BSP & 3/4" BSP



EXTENDED TEST PLUG
BP15 - 1/2" BSP Test Plug with self sealing drain cap



TEST PLUG
PH15 - 1/2" BSPT

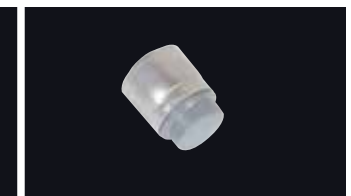

PIPE END PLUGS
PG15 - 15mm
PG20 - 20mm
PG28 - 28mm

Buteline PB-1 Plumbing System



NAIL PIPE CLIPS

BA18 - 18mm
BA22 - 22mm
BA28 - 28mm

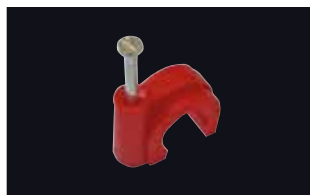

PIPE CLIPS FOR HOT WATER LINE

BAR18 - 18mm
BAR22 - 22mm

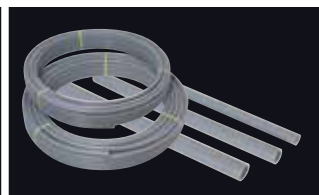

PB-1 PIPE

BC18 - 18mm x 50m Coil
BC22 - 22mm x 50m Coil
BL18 - 18mm x 5m Lengths
BL22 - 22mm x 5m Lengths
BL28 - 28mm x 5m Lengths

METAL SCREW PIPE CLIPS

BAS18 - 18mm
BAS22 - 22mm
BAS28 - 28mm



LAY FLAT PB-1 PIPE COILS

BSC18 - 5 x 18mm x 10m Lengths
BSC22 - 5 x 22mm x 10m Lengths

LAY FLAT PB-1 PIPE COILS FOR HOT WATER LINE ID (FOR INDOOR USE ONLY)

BSCH18 - 5 x 18mm x 10m Lengths
BSCH22 - 5 x 22mm x 10m Lengths



HOT WATER LINE ID PB-1 PIPE (FOR INDOOR USE ONLY)

BCH18 - 18mm x 50m Coil
BCH22 - 22mm x 50m Coil
BLH18 - 18mm x 5m Lengths
BLH22 - 22mm x 5m Lengths

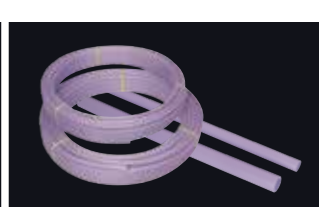

GREY WATER / RECYCLED WATER PB-1 PIPE

BCR18 - 18mm x 50m Coil
BCR22 - 22mm x 50m Coil
BLR18 - 18mm x 5m Lengths
BLR22 - 22mm x 5m Lengths



RAINWATER PB-1 PIPE

BCG18 - 18mm x 50m Coil
BCG22 - 22mm x 50m Coil
BLG18 - 18mm x 5m Lengths
BLG22 - 22mm x 5m Lengths



PIPE CUTTER

PC30 (Yellow)



CLAMP TOOLS

FR20 - 15mm
FR25 - 20mm
FR28 - 28mm

15mm, 20mm & 28mm Range

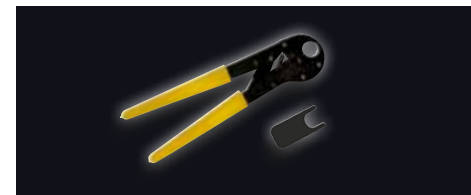

PROCLAMP TOOLS

PRO18 - 15mm
PRO22 - 20mm

Includes checking gauge.



QUICKCLAMP MINI TOOL

QC20 - 15mm

Includes checking gauge.



ELECTRIC CLAMP TOOL & JAWS

ET01 - Boxed kit includes tool with battery, charger and a set of 3 jaws.

ETJ18 - 15mm jaws
ETJ22 - 20mm jaws
ETJ28 - 28mm jaws

Jaws for the electric tool are also available individually for purchase.



BUTE GETS YOU GOING PACK

GG01 - 2 clamp tools (15mm & 20mm), a pipe cutter, and a selection of the most popular fittings.



BUTE PRO STARTER PACK

BPP10 - 2 ProClamp Tools (15mm & 20mm), a pipe cutter and a selection of useful fittings.

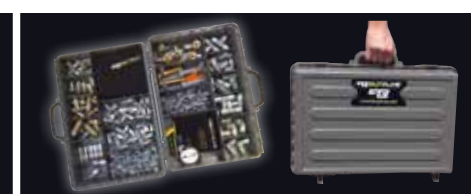

BUTE FITTINGS CASE

BUTEFC - A quality fittings case with Buteline product (pictured).

BUTEC - This tough and durable tradesman's case is also available empty.

Buteline PB-1 Plumbing System



EQUAL TEE
T12 - 12mm x 12mm x 12mm

REDUCING TEES
TR001 - 12mm x 12mm x 15mm
TR002 - 12mm x 12mm x 20mm
TR110 - 15mm x 15mm x 12mm
TR220 - 20mm x 20mm x 12mm

FEMALE SWIVEL
F12 - 1/2" BSP x 12mm



INLINE COUPLING
S12 - 12mm x 12mm

REDUCING COUPLINGS
S1512 - 15mm x 12mm
S2012 - 20mm x 12mm

BRASS MALE ADAPTOR
M12B - 1/2" BSP x 12mm



EQUAL ELBOW
E12 - 12mm x 12mm

FEMALE SWIVEL ELBOW
FE12 - 1/2" BSP x 12mm

FEMALE WING BACK ELBOW
WE12 - 1/2" BSP x 12mm

12mm Range



MALE WING BACK ELBOW
WM12100 - 1/2" BSP x 12mm x 100mm

PIPE END PLUG
PG12 - 12mm

NAIL PIPE CLIP
BA12 - 12mm



PB-1 PIPE COILS
BC12 - 12mm x 25m Coil
BC12100 - 12mm x 100m Coil*
* Coils of longer length (eg: 100m, 150m or 200m) are available by special request.

LAY FLAT PB-1 PIPE COIL
BSC12 - 5 x 12mm x 10m Lengths

HOT WATER LINE ID PB-1 PIPE COILS (FOR INDOOR USE ONLY)
BCH12 - 12mm x 25m Coil
BCH12100 - 12mm x 100m Coil*
* Coils of longer length (eg: 100m, 150m or 200m) are available by special request.

PB-1 PIPE LENGTHS
BL12 - 12mm x 5m Lengths

LAY FLAT PB-1 PIPE COIL FOR HOT WATER LINE ID (FOR INDOOR USE ONLY)
BSCH12 - 5 x 12mm x 10m Lengths

HOT WATER LINE ID PB-1 PIPE LENGTHS (FOR INDOOR USE ONLY)
BLH12 - 12mm x 5m Lengths



PIPE CUTTER
PC30 (Yellow)

QUICKCLAMP MINI TOOL
QC12 - 12mm

Includes checking gauge.

BUTE FITTINGS CASE FOR 12MM
BUTEFC12 - A smaller fittings case with a selection of Bute 12mm fittings.
BUTE12 - This smaller fittings case is also available empty.

Buteline Fittings

Buteline have developed an extensive range of quality fittings which have complete compatibility with Buteline Polybutene-1 pipe.

The annealed protective metal sleeve is precisely attached to each fitting during production and is designed to provide a unique metal reinforced joint. Users of Buteline fittings will therefore find the total concept much quicker and more economical than other available systems.

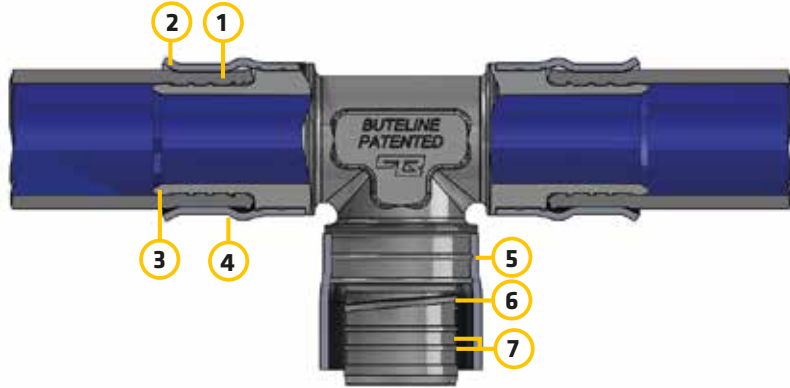

- 1 WIDE FORGED CLAMP**
Minimum working stress applied (approx. 0.5 ton per sq. in.) allowing pipe material to "flow" into insert tail grooves.
- 2 2mm WIDE FLARE**
No stress from clamping transmitted to insert tail or pipe at end of fitting. End of metal sleeve cannot impinge into pipe, even in bending.
- 3 TAPERED ENTRY, SMOOTH BORE**
Minimise resistance to water flow.
- 4 METAL REINFORCING SLEEVE**
Guarantees no stress break in this critical area.
- 5 FULL LENGTH ALUMINIUM SUPPORT**
Provides additional rigidity and resistance to pull-off. Seals against dirt and moisture.
- 6 SUREFIT HELIX**
Patented design feature prevents pipe from falling off sleeve, ensures precise positioning.
- 7 SEALING RIBS**
Narrow lands with wide grooves, ensure clamp stress is transferred into the pipe joint efficiently.

Buteline Polybutene-1 Pipe

Buteline Polybutene-1 pipe is produced in 12mm, 15mm, 20mm and 28mm sizes. 12mm size pipe is available in 10m straight coils, 25m coils, 100m coils and 5m straight lengths. 15mm size pipe is supplied in 10m straight coils, 50m coils and 5m straight lengths (100m, 150m and 200m coils are available by special request).

20mm size pipe is supplied in 10m straight coils, 50m coils and 5m straight lengths.

28mm is available in 5m straight lengths only.

Pipe identification marks are printed at 1 metre intervals and indicator lines provide a guide during installation.



Buteline grey pipe is manufactured in New Zealand to meet the exacting Australian and New Zealand Standard AS/NZS 2642.

Buteline grey Polybutene-1 pipe is approved for use on both hot and cold potable water services. It also complies with the AS/NZS 4020 Food Grade Standard. Flexible, tough and non-corrosive, Buteline Polybutene-1 pipe can withstand high temperatures and pressures (see page 41).



Manufacturing coils on the Buteline Pipewinder Buteline pipe lengths

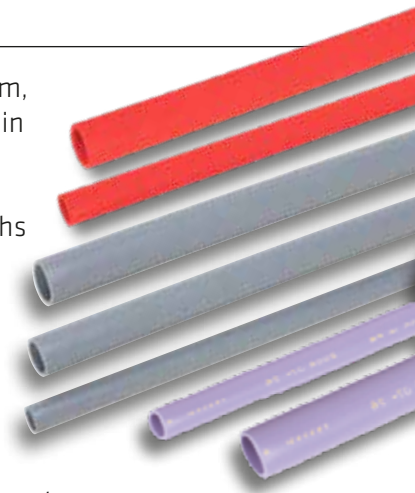

Buteline Clamp Tools

Buteline have engineered their clamp tools to ensure a simple, controlled, accurate joint every time. They have a “head” design which permits easy access and alignment. The Buteline clamp tool is available in four sizes to suit 12mm, 15mm, 20mm and 28mm Polybutene-1 pipe fittings.

The 15mm and 20mm tools are available in a mini size as pictured below (ProClamp). An electric tool is also available, with jaws in 15mm, 20mm and 28mm available individually for purchase.

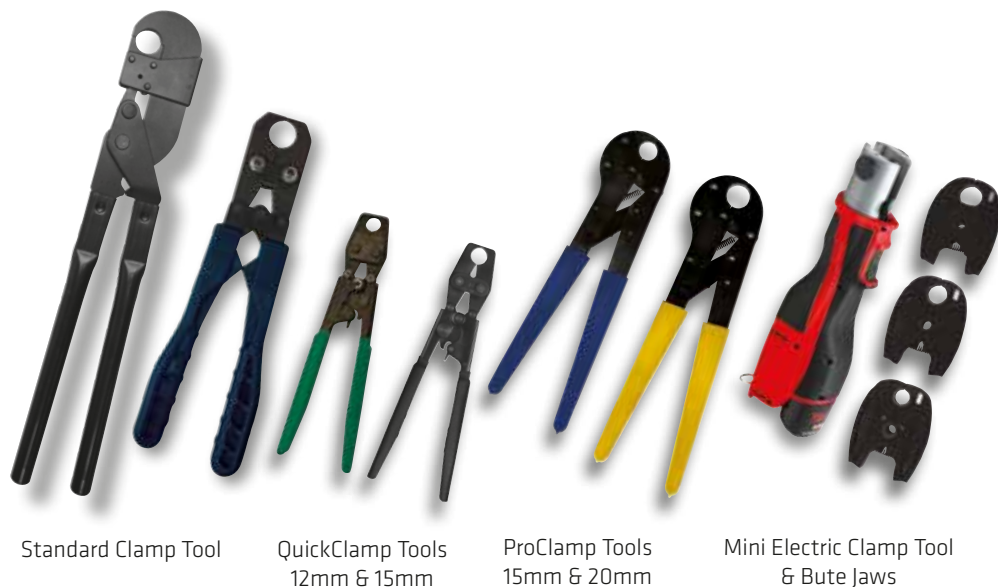

Servicing Your Clamp Tool

Buteline PB-1 clamp tools are a very important part of the system. They are extremely robust and designed to perform up to a consistent high standard for many years. Service your clamp tool by cleaning and oiling moving parts regularly. WD40 is an ideal cleaner/lubricant. The standard clamp tools do not require adjustment.

Buteline clamp tools must only be used with the Buteline Plumbing System.

How To Check Your FR Clamp Tool



1. To check the operation of your standard (FR type) clamp tool, hold the fixed side handle parallel to a reasonably level surface and open the moving side handle fully.

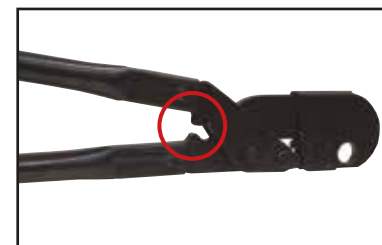

2. Let the moving handle drop under gravity. If the handle stops BEFORE it reaches the stops on the inside of the handles, the tool is OK and usable.



3. If, however, the handles close all the way to the stops, then the tool requires replacement.

NOTE: The Buteline standard FR type clamp tool is not adjustable.



Watch a demo online at tinyurl.com/FRTool for more information.



Installation Demonstration for FR Non-Adjustable 15mm & 20mm Clamp Tools



1. Cut the pipe on an indicator line with the Buteline pipe cutter.

To assist the pipe cutting process, slightly twist the pipe as you begin to cut.

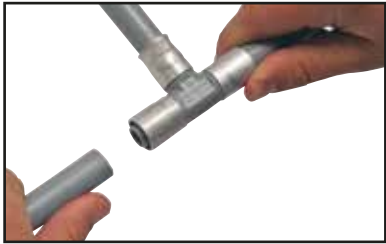

2. Insert the pipe into the Buteline fitting. Ensure you push the pipe all the way (14mm) with a slight twist to 'SureFit' onto the shoulder of the fitting, up to the next indicator line of the same size.



3. *Clamp-Hold-Release*
Clamp approximately 2mm in from the end of the fitting, close the tool handles completely to the stops provided, and hold firmly for around 2 seconds then release.



4. The process of installing the system is clean and quick, leaving a watertight mechanical joint.

Installation Demonstration for ProClamp Tools, QuickClamp Mini Tools & 28mm Clamp Tool



1. Cut the pipe on an indicator line with the Buteline pipe cutter.
To assist the pipe cutting process, slightly twist the pipe as you begin to cut.

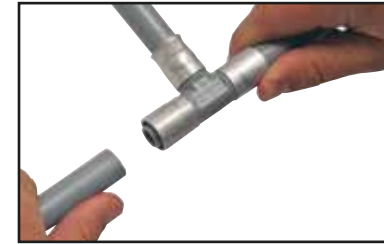

2. Insert the pipe into the Buteline fitting. Ensure you push the pipe all the way (14mm) with a slight twist to 'SureFit' onto the shoulder of the fitting, up to the next indicator line of the same size.

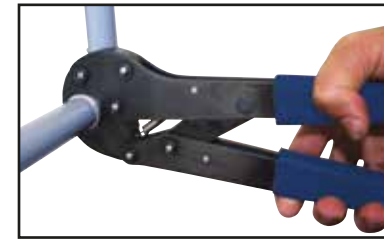

3. *Clamp-Hold-Release*
Clamp once only, approximately 2mm in from the end of the clamp ring. Close the clamp tool handles completely, holding firmly for around 2 seconds and then the tool will release.



4. Use the gauge provided to check that the full clamp force has been achieved. If the gauge does not pass over the ring, the ring is under-clamped. It is important that the gauge passes over the clamp ring. Take corrective action by re-adjusting the tool (see pages 20 & 21) and then re-clamping.

15mm & 20mm ProClamp Tool Adjustment Instructions



1. Identify the position of the adjuster cam.



2. Turn the tool over and remove the circlip securing the adjuster cam.



3. Retain the circlip for replacement after adjustment.



4. Push the adjuster cam out from the circlip side until the hexagon head of the cam disengages from the handle, and turn the cam clockwise, so that it is moved around 1 flat of the hexagon.

5. Push the hexagonal head of the cam back into the handle and replace the circlip to retain the adjuster cam.

NOTE: The maximum adjustment has been achieved when the adjusting cam has been rotated 180°. Do not adjust your ProClamp Tool more than 5 times in its life cycle.

28mm Clamp Tool Adjustment Instructions



1. Open the tool and remove the screw.



2. Lift the adjuster and rotate *clockwise* by 1 notch.



3. Replace the screw.



4. Use the gauge provided to check for correct clamp width.



Installation Guide

Carry out installations with a professional manner. Use the complete "Buteline" system – clamp tools, pipe, fittings, etc.

Preparation Of Pipe

- (a) Pipe must be clean and free from grease or any other contamination.
- (b) Pipe must have no kinks, buckled sections, deep scores, etc.
- (c) When measuring, allow 15mm of pipe for each fitting.
- (d) Allow enough length for expansion / contraction (minimum 10mm per metre).
- (e) Cut the pipe to length squarely and cleanly on an indicator line using only approved pipe cutters.



Position Of Fittings

- (a) Pre-position fittings correctly on the pipe to achieve alignment with all other pipework prior to final clamping.

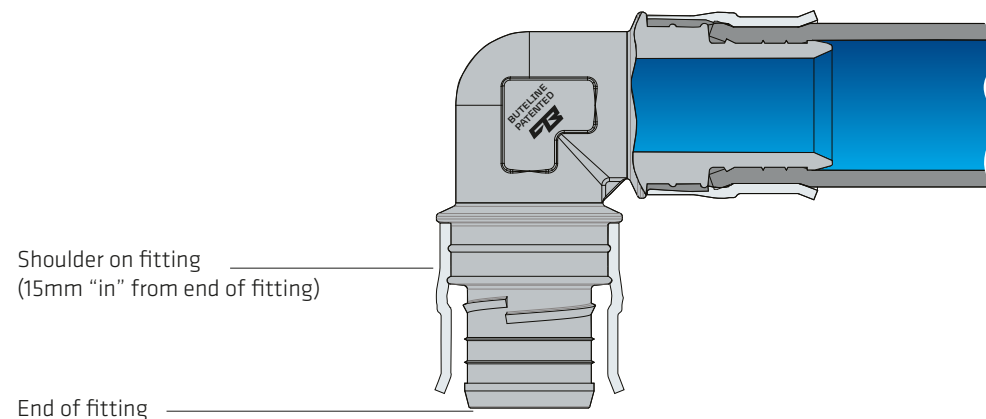

- (b) Fully insert (push home to shoulder) with a slight twist to SureFit the pipe into Buteline fittings, up to the next visible indicator line of the same size to ensure full engagement of pipe into the fitting.

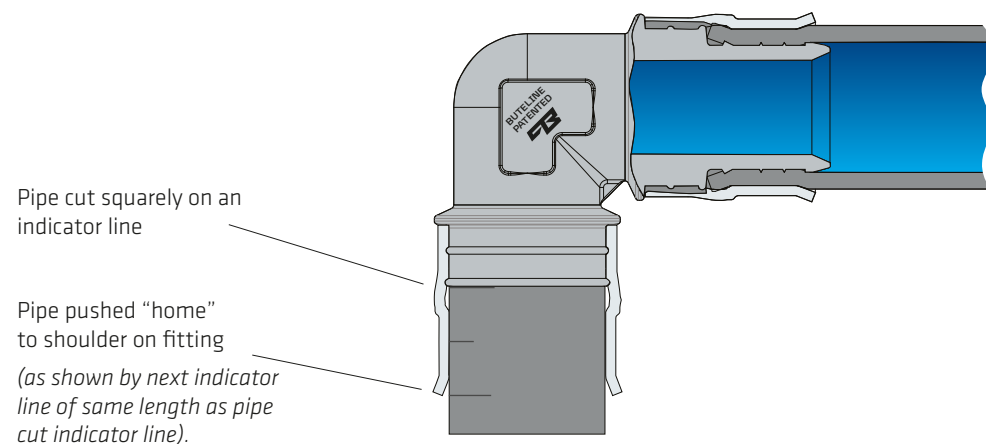

Clamping Buteline Fittings

- (a) Position the Buteline clamp tool squarely and approximately 2mm from the end of the factory fitted reinforcing clamp ring.

Correct Clamp Tool Position

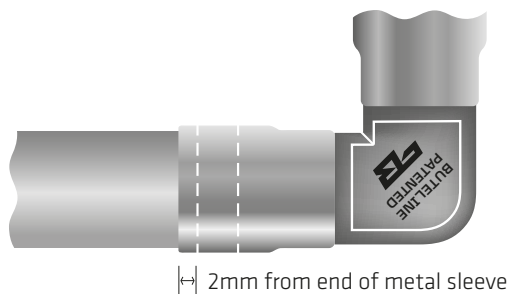

- (b) Close clamp tool handles completely (to the stops provided), hold fully closed for approximately 2 seconds, then release.

- (c) A good clamp will produce a “flare” at the end of the reinforcing ring. The “flare” shows that the full clamp width has been applied to the joint - and the designed result achieved. (It is important that a full clamp width is achieved).

Correct Appearance Of Best Joint

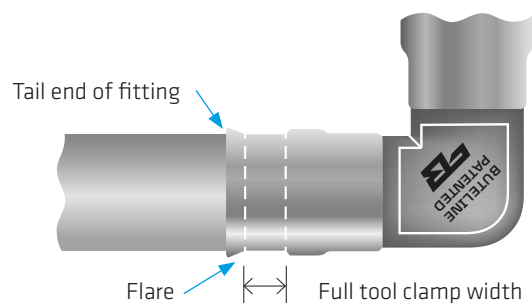

INSTALLER NOTE:

Failing to install Buteline fittings as advised in this Installation Manual voids all warranties. If joints are not made as per this manual, please remove and replace with a new fitting.

- (d) Be methodical – ensure you clamp all fittings on the job, and do not double clamp.
- (e) All joints must be clamped squarely across the fitting as angled clamping can lead to unacceptable stress levels being imparted onto the fitting and pipework which could lead to premature failure.
- (f) When gauging, note where the jaw gap witness is on the fitting clamp ring. The gauge must be passed over the clamp ring at 90° to the jaw gap witness (see diagram below):

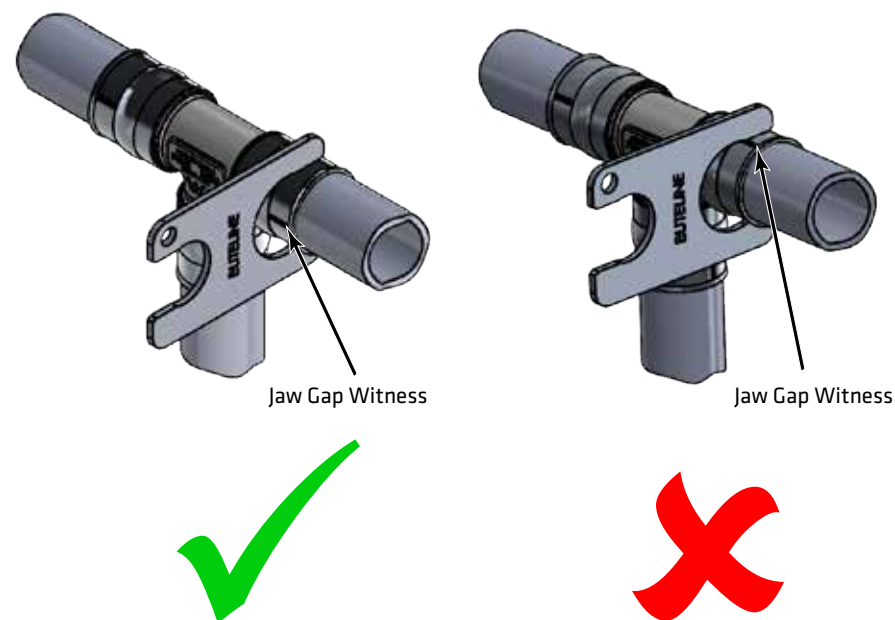

Use Only The Complete Buteline System

The use of the complete Buteline System (Buteline pipe, Buteline fittings, Buteline clamp tools) is imperative for a number of reasons:

- ✓ **Buteline offers a guarantee ONLY when the complete Buteline System (BUTE PIPE, BUTE FITTINGS, BUTE TOOLS) is used.**
- ✓ Buteline pipe is made to specific tolerances for use with the Buteline fittings to give a strong, leak-proof and PERMANENT joint every time. Only Buteline pipe is manufactured to the exacting standard demanded by the Buteline range of fittings.
- ✓ The exclusive use of Buteline components ensure a PROFESSIONAL TRADESMAN-LIKE job every time.

The complete Buteline Plumbing System offers the plumber many advantages, including:

- ✓ **Speed:**
The Buteline clamping method is one of the fastest, most reliable PB-1 plumbing systems available.
- ✓ **Extensive product range:**
Useful and innovative fittings specifically designed and engineered for the professional plumber.
- ✓ **Total commitment and dedication to the plumbing industry:**
Buteline is a specialist in plumbing systems and will always be the leader in Polybutene-1 plumbing systems.

Storage and Handling

- (a) Store fittings so that they cannot be damaged by heavy tools, etc. It is a good idea to have a tool box to carry the large range of fittings available.
- (b) Take care to keep the Buteline Plumbing System and any uninstalled Buteline pipe away from chemicals, solvents, cements, oxidising agents or petroleum products.
- (c) Store the Buteline system away from direct sunlight and high temperature sources (e.g: heaters, boilers, gas / central heating / appliance vents).
- (d) Avoid dragging pipe across rough surfaces to prevent possible damage to pipe surface.



Call 0800 BUTELINE or your local representative for more information about a BUTE fittings case. Available from your plumbing merchant.

“Feeding” Buteline PB-1 Pipe Through Timbers

- (a) “Pipe sleeves” and bored holes should be large enough to allow free movement of Buteline PB-1 pipe.

Minimum Hole Sizes:

Use 17mm drills for – 12mm pipe (Type 15)
 Use 20mm drills for – 15mm pipe (Type 18)
 Use 25mm drills for – 20mm pipe (Type 22)
 Use 32mm drills for – 28mm pipe (Type 28)

- (b) Larger holes may be required to ease pipe through if changing direction.

- (c) Use of silicone in the holes is not required.



NOTE:

If sealing Buteline pipe where it passes wooden framing, a natural cure silicone can be used. Do not use an acid cure silicone sealing system as this may have a detrimental effect on the PB-1 pipe.

NOTE:

If running Buteline PB-1 pipe through steel framing, use plastic grommets (as supplied by the steel frame fabricator) to protect the pipe from sharp metal edges.

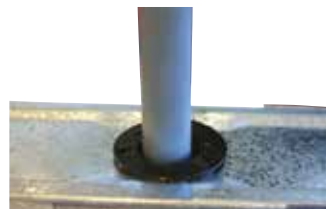

Bending Radius

Buteline Polybutene-1 pipe should be installed ensuring any bending radius is at least 10 times the outside diameter of the pipe.

Sharp bends should be made with appropriate fittings.

Pipe Size	Minimum Bending Radius
12mm (O.D. 13mm) (Type 15 PN 16)	120mm
15mm (O.D. 16mm) (Type 18 PN 16)	160mm
20mm (O.D. 22mm) (Type 22 PN 16)	220mm
25mm (O.D. 28mm) (Type 28 PN 16)	280mm



Pipe Clipping

There are 2 types of Buteline pipe clips available:



Timber / masonry clip



Metal framing screw clip

- (a) Remember that Buteline PB-1 Pipe is flexible but must not be “anchored tightly” between two points.
- (b) Pipes unsupported by clips are unsightly and can be damaged.

Maximum Spacing of Clips (metres)		
PB-1 Pipe	Horizontal or graded pipes	Vertical pipes
12mm (Type 15)	0.5	1.0
15mm (Type 18)	0.60	1.2
20mm (Type 22)	0.70	1.4
25mm (Type 28)	0.75	1.5

Buteline Polymer Threaded Connections

- (a) It is essential to use (PTFE) pipe thread tape - use a small amount and wrap correctly onto male thread connectors (ME15, M20, etc).
- (b) Avoid using liquid thread sealer compounds on Buteline polymer threaded fittings.
- (c) **DO NOT OVERTIGHTEN AS THREADS ARE TAPERED** and therefore will tighten with less turns compared to male parallel threads. Hand tighten plus a ½ turn.



Buteline Swivel Connections

- (a) Ensure that when using polymer female swivel connectors, the shoulder of the female is directly presented squarely to a flat machined face before tightening. This avoids crossed threads and ensures a seal. No (PTFE) pipe thread tape or sealant required.
- (b) When connecting copper pipe to Buteline fittings (TC15, TK15 etc.), use only an olive (plastic ‘relf’ ring or similar), or crox and connect - there is no need for hemp.
- (c) When installing all male or female threaded fittings, best practice is to fit and tighten the threaded end of the fitting **PRIOR** to clamping the pipe onto the tail of the fitting.



Connecting to Brazing Tails



Before commencing any work involving heat processes, be sure to check that hot work is permitted.

1. Cut the copper pipe to length, ensuring the end is square and clean.



2. Slide the brazing tail socket onto the copper pipe, ensuring that the aluminium and plastic clamp ring assembly has been removed.



3. Use suitable flux and SilFos to make the joint between the fitting and the copper pipe.



4. AFTER the solder joint has COOLED, slide the aluminium clamp ring assembly onto the PB-1 tail of the fitting, ensuring it goes fully up to the fitting shoulder.



5. Simply insert the PB-1 pipe into the Buteline fitting and push fully home to the shoulder of the fitting.



6. *Clamp - Hold - Release*

- Clamp the Buteline fitting, using ONLY the Buteline clamp tool.
- Position the Buteline clamp tool squarely, approximately 2mm in from the end of the clamp ring.
- Close handles to stops, holding in the tightly closed position for around 2 seconds to ensure that the flow of material is performed. Open and remove the tool.



7. Finished.

- The process is complete!
- Installing the Buteline System is quick and secure and always provides a visual indicator of joint completion.

Installing Buteline Underground

- (a) If 'jointing' underground or in a marine environment is necessary, wrap the aluminium rings directly and completely using a waterproof insulation tape.

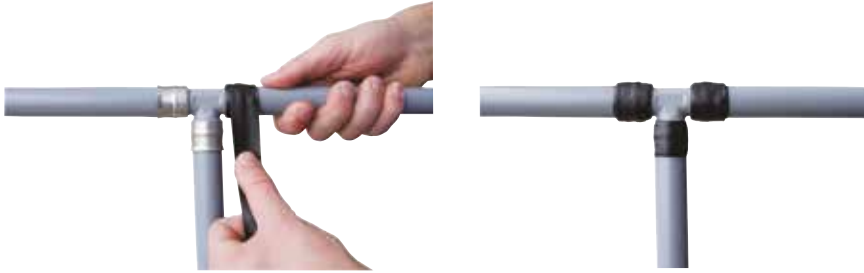

- (b) In areas of corrosive soil that consist of substances such as:
- Magnesium oxychloride (magnesite)
 - Coal wash
 - Acid sulphate soils
 - Sodium chloride (salt)
 - Ammonia
 - Lime

The metallic surface of Buteline fittings (brass / aluminium) must be continuously wrapped in a petrolatum taping material (waterproof) as per AS/NZS 3500.

- (c) New water mains – take Buteline PB-1 20mm / 28mm pipe from water meter to dwelling. This practice will give maximum water flow at all service points.
- (d) Lay Buteline PB-1 pipe in the bottom of the trench - check that there are no sharp objects that may penetrate or damage the pipe.
- 'Snake' the pipe the entire length underground to allow for expansion and contraction.
- (e) Trench depth and installation must conform to plumbing and drainage regulations.

Installing Buteline in Concrete / Masonry

- (a) Use a pipe sleeve when burying Buteline PB-1 pipe in concrete. Pipe sleeves should be large enough to allow free movement for expansion and contraction.
- (b) A pipe sleeve is not required when installing a low temperature / pressure underfloor heating system (refer to manufacturer).
- (c) Buteline PB-1 pipe installed in concrete slabs, footings etc. must have no joints, and must be in accordance with local building codes (AS/NZS 3500 Parts 1 & 4).
- (d) When installing in concrete / cement plastered walls, use a pipe sleeve to allow free movement for expansion and contraction. If jointing is necessary, wrap the aluminium rings directly and completely using a waterproof insulation tape such as Denso Tape or PVC insulation tape (shown as point (a) on page 34).

Installing Buteline in Marine Environments

When installing in marine environments where the fittings are subject to salt water exposure, wrap the aluminium rings directly and completely using Denso Tape or PVC insulation tape (shown as point (a) on page 34).

Chlorine

Polybutene-1 should not be installed in areas where the water supply is likely to have chlorine content of over 2 parts per million, as this will shorten its working life. Check with your local territorial authority/water utility.

INSTALLER NOTE: *In locations with known problems of fitting/pipe corrosion or where the water is or is suspected to be highly corrosive, eg: in volcanic areas, in installations using bore/well water or in applications using water with high chlorine content which may fluctuate higher than the World Health Organization (WHO) levels, there is a danger that fittings/pipe may corrode/degenerate. The suitability and warranty coverage of the Buteline Plumbing System in such installations require a prior independent consultation with Buteline to validate if fit for purpose in the designated environment. In some cases, the accessible or nearby water quality may also void the Buteline warranty unless appropriate water treatment is provided in consultation with Buteline. The responsibility is that of the installer to verify -- if unsure please seek professional advice by consulting your local water authority and/or the manufacturer.*

Freezing Conditions

Buteline PB-1 pipe is the best choice for water reticulation in climates where freezing conditions are possible.

Due to its flexible nature, Buteline PB-1 pipe will absorb the expansion of frozen water within itself and will absorb the additional expansion created by the water freezing inside a rigid fitting and expanding into the pipe, without splitting.

Minimise possible problems by taking the following precautions:

- ✓ Make sure that any metal pipe to PB-1 pipe joints are made in a non-freezing area.
- ✓ Ensure 150mm between fittings so that ice expansion from a rigid pipe or joints can be absorbed by the PB-1 pipe.
- ✓ Bury PB-1 pipe where practical.
- ✓ Insulate PB-1 pipe heavily where freezing conditions may prevail.
- ✓ Avoid placing PB-1 pipework within 'polar-facing' walls, where practical.

UV Exposure

The Buteline System should be adequately protected against exposure to direct sunlight when located (either vertically or horizontally) on the exterior of a building, either using pipe sleeving, lagging or water-based paint.

Thermal Conductivity

The thermal conductivity of copper is 400W/m/°C, compared to that of Polybutene-1, which is 0.217 W/m/°C. Copper is more than 1,800 times more conductive than PB-1 pipe, so will lose at least 1,800 times as much heat through the pipe.

Furthermore, PB-1 pipe has a thicker wall thickness in comparison to copper which further decreases the temperature loss through the pipe wall.

Fire Information

CAS-No. for Polybutene-1 (PB-1): 9003-28-5

Calorific Value: 8000 – 11,000 kcal/kg

Safety Data

Lower Explosion Limit: The minimum explosive concentration (MEC) for polymer dust varies according to particle size distribution.

Upper Explosion Limit: Not applicable.

Flammability (solid, gas): Polymer will burn but does not easily ignite.

Autoignition temperature: > 300°C

Melting point/range: 50 – 170°C

Fire Protection

Buteline PB-1 pipe which penetrates fire resistant construction must be installed to ensure the fire resistant integrity of the building is retained (refer to local building code).

To achieve the fire rating that is required for the nominated building specification, fire rated silicone and fire collars are suitable for use with the Buteline Plumbing System.

Riser ducts are constructed to achieve a specific fire rating for the building, and fire collars or fire rated silicone (or similar) will need to be used for each service penetrating a wall or floor.

(Floor) riser ducts are typically required to have a 4 hour fire rating.

Walls are typically required to have a 2 hour fire rating.

Under the NZ Building Code requirements for passive fire protection, it requires fire stopping of service penetrations to be tested to Australian Standards.

Australian Standards (AS 1530-4) for Fire Rating and the Building Code of Australia

AS 1530-2005 is the Australian Standard for methods for fire tests on building materials, components and structures. The standard provides requirements for heating conditions, test procedures, and criteria for determining the fire resistance of an element of building construction to building designers, manufacturers, test laboratories and regulatory authorities. This Standard is referenced in the Building Code of Australia and New Zealand and Part 4 of this Australian Standard details the fire resistance testing of elements of construction, which covers testing of fire resistance relating to installation of plumbing systems in buildings.

Passive fire protection is available from Ryanfire (www.ryanfire.co.nz) and fire collars are available from Allproof Industries (www.allproof.co.nz), please contact them for more information.

Passive Fire Protection Guide



V22.9



16mm FR PLASTERBOARD CEILING

Up to Ø28mm Polybutylene pipe
40mm Ryanfire SL Collar &
Ryanfire HP-X
-/30/30

V23.4



UNLINED CEILING (TIMBER FRAME)

Up to Ø28mm Polybutylene pipe
50mm Ryanfire Batt &
2 layers Ryanfire Strap
-/60/60

V25.9 & 25.13



CONCRETE FLOORS

Up to Ø28mm Polybutylene pipe
Ryanfire TD Collar
& Ryanfire Mastic
100mm floor 150mm floor
-/120/90 -/120/120

V25.14



COMPOSITE FLOORS

Up to Ø28mm Polybutylene pipe
Ryanfire TD Collar & Ryanfire Mastic
120mm Composite floors
-/120/60

V25.15



100mm CONCRETE FLOORS

Up to Ø28mm Polybutylene pipe
Ryanfire 40mm SL Collar &
Ryanfire Mastic
-/120/

V20.12



UNLINED WALLS (TIMBER FRAME)

Up to Ø28mm Polybutylene pipe
80mm Ryanfire Batt &
2 layers Ryanfire Strap
-/60/60

V21.5



13mm FR PLASTERBOARD WALLS

Up to Ø28mm Polybutylene pipe
Ryanfire 40mm SL Collar &
Ryanfire Mastic
-/60/45

V20.11



26mm FR PLASTERBOARD WALLS

Up to Ø28mm Polybutylene pipe
Ryanfire HP-X
116mm thick wall
2 layers 13mm FR plasterboard
-/120/30

V20.8



26mm FR PLASTERBOARD WALLS

Up to Ø28mm Polybutylene pipe
Ryanfire SL Collar & Intumastic HP
2 layers 13mm FR plasterboard
-/120/120

V20.19

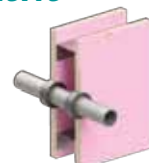

26mm FR PLASTERBOARD WALLS

Up to Ø28mm Polybutylene pipe
Intumastic HP
116mm thick wall
2 layers 13mm FR Plasterboard
-/120/120

V20.20



26mm FR PLASTERBOARD WALLS

Up to Ø28mm Polybutylene pipe
50mm Ryanfire Batt & Ryanfire Strap
116mm thick wall
2 layers 13mm FR Plasterboard
-/120/60

V20.9



13mm FR PLASTERBOARD WALLS

Up to Ø28mm Polybutylene pipe
Ryanfire HP-X
90mm thick wall
One way seal
-/90/90

**Please note the seal information is for the maximum pipe diameters. Actual seal fire performance & approvals may exceed what is shown. Please contact Ryanfire for details and specific fire performance information.*

All seals tested to AS1530.4

Tel 09 443 0362 Email: info@ryanfire.co.nz
www.ryanfire.co.nz

Buteline Internal Bore Sizes

Pipe		Fittings	
Pipe Size	I.D. of Pipe (mm)	Fitting Size	I.D. of Fittings (mm)
12mm (Type 15 PN 16)	9.3	12mm	6.4
15mm (Type 18 PN 16)	12.5	15mm	9.4
20mm (Type 22 PN 16)	17.6	20mm	14.2
25mm (Type 28 PN 16)	22.2	25mm	18.0

Pipe Wall Thickness

Due to its chemical properties, only Polybutene-1 (PB-1) piping can achieve high temperature and high stress but maintain lower wall thickness to ensure adequate water-flow through the pipe network.

Lower wall thickness also means a larger internal bore for a given external pipe diameter, resulting in reduced head pressure loss and lower flow speeds to deliver a fixed volume of water.

A comparison of the inside diameter / thickness of Polybutene-1 (PB-1) with other plastic materials is shown in the following graph:

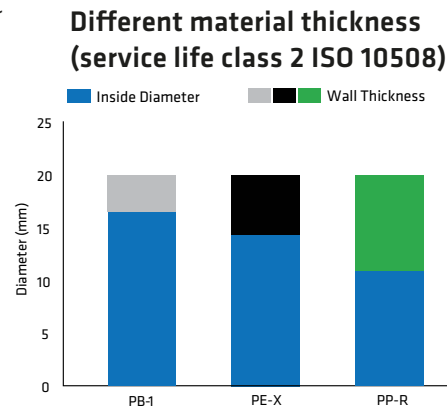

Working Pressure

As stipulated in ISO 10508, the lifetime of Polybutene-1 (PB-1) pipe is 50 years and longer according to permissible working pressure / temperature.

Buteline PN 16 PB-1 Pipe

Temperature °C	Pressure	
	kPa	P.S.I.
20	1600	232
40	1370	198
60	1050	152
70	880	128
80	740	108

NOTE:

These pressures are maximum for each temperature level and should not be exceeded.

Buteline PB-1 pipe has a recommended maximum long term operating temperature of 80°C and is not recommended for applications where the continuous operating temperature may exceed this limit. Buteline will not guarantee its PB-1 pipe and fittings system where long term operating may exceed 80°C.

Buteline recommends that a suitable pressure limiting valve is installed on the inlet side of the property to ensure water pressure does not exceed pipe pressure limits.

Pipe Pressure Head Loss for Polybutene-1 Pipe

Pressure / Head Loss per 30 Metres (100 Feet) of Pipe

Minimum Flow Required / Min		12mm (Type 15)		15mm (Type 18)		20mm (Type 22)		25mm (Type 28)	
Litres	Gallons	kPa	P.S.I.	kPa	P.S.I.	kPa	P.S.I.	kPa	P.S.I.
18.0	4	622.20	90.22	163.45	23.70	30.88	4.48	9.97	1.45
22.5	5	939.60	136.24	247.00	35.81	46.67	6.77	15.06	2.18
27.0	6	1317.00	190.67	346.08	50.18	65.39	9.48	21.11	3.06
31.5	7	1751.00	254.00	460.29	66.74	86.96	12.61	28.07	4.07
36.0	8	2242.50	325.16	589.27	85.44	111.33	16.14	35.94	5.21
40.0	9	2725.00	395.15	716.09	103.83	135.29	19.62	43.67	6.33
45.0	10	3388.00	491.38	890.43	129.11	168.23	24.39	54.30	7.87

Please refer to page 64 for a Pressure Conversion Chart.



Hot Water Installations

- (a) Buteline PB-1 installations should have a minimum of 1 metre of copper tube from the hot water cylinder. When using a tempering valve, use Buteline PB-1 pipe direct from mixing outlet.
- (b) All installations supplying hot water that are to be utilised for personal hygiene require a tempering valve to be installed on the outlet side of the hot water cylinder. This ensures safe temperatures for the householder at the tap.
- (c) Instantaneous domestic water heaters do not require 1 metre of copper tube on the outlet. Buteline PB-1 pipe can be connected directly to the outlet.
- (d) Do not use Polybutene-1 pipe for “wet back” to cylinder plumbing as wet backs constantly exceed 80°C.
- (e) When commissioning the plumbing system, set and test the temperature of the hot water cylinder. Hot water cylinder thermostats should be set at a maximum of 60°C as part of the test procedure.

With a setting of 60°C the hot water system can be maintained within operating requirements and a long service life is expected for the complete plumbing system.

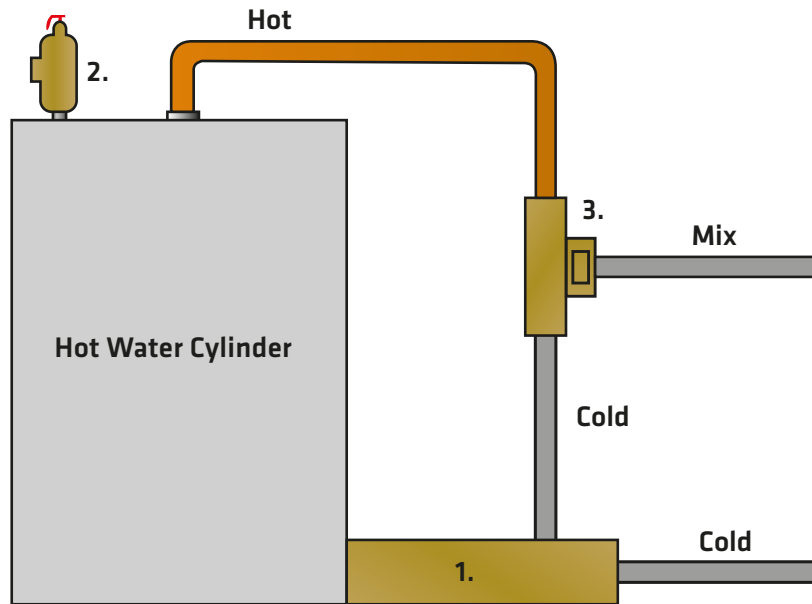
Typical High Pressure Hot Water Cylinder





Buteline PB-1 Pipe 
Copper Pipe (minimum 1m) 

- 1. Non-Return Valve
Isolating Valve
Expansion Valve
Limiting Valve
- 2. Temperature Pressure Relief Valve
- 3. Tempering Valve

* Ref AS/NZS 3500.4:2003

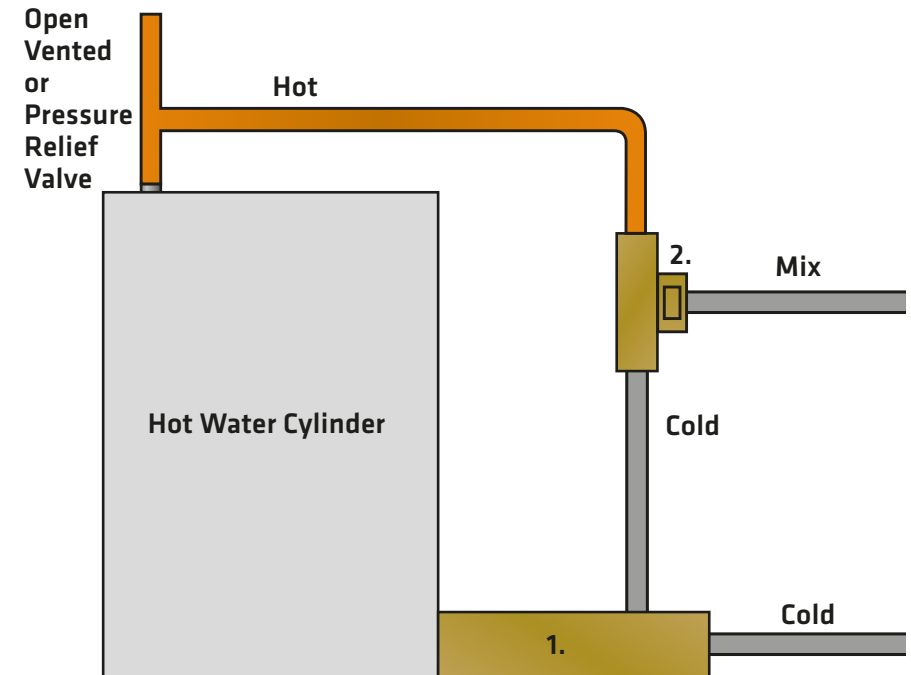
Typical Low Pressure Hot Water Cylinder



Buteline PB-1 Pipe 
Copper Pipe (minimum 1m to tempering valve) 

- 1. Pressure Reducing Valve
Non-Return Valve
Isolating Valve
- 2. Tempering Valve

* Ref AS/NZS 3500.4:2003

Solar Hot Water

As solar hot water systems are an uncontrolled heat source, temperatures over 80°C are frequently experienced, therefore the Buteline Plumbing System must be installed in a manner to protect the system from excessive temperatures.

- (a) The Buteline Plumbing System is able to be connected to a solar heated storage cylinder outlet provided it is connected after an approved solar tempering valve only.
- (b) Individual tempering valves are then fitted as required to control water supply temperature to the wet areas in accordance with AS/NZS 3500 Part 4.2.
- (c) Do not use Polybutene-1 pipe for solar heater-to-cylinder plumbing.

Re-circulating Continuously Operating Ring Main Hot Water Systems

A continuously operated re-circulating system is a hot water supply system which provides hot water to outlets and incorporates all three of the following:

- Is maintained at a temperature above 60°C.
- Is replenished with an incoming water supply to replace the water drawn to outlets.
- Is a pumped, circulating system.

Continuously operated re-circulating systems are very different from conventional hot water supply and central heating systems found in domestic properties, for which our products have been tested to, under either AS/NZS 2642 or WaterMark approval standards, and for this reason these products must not be used on any continuously operated re-circulating systems as they are not approved under the current version of these standards. Manufacturers' own technical information should always be consulted as specific product limitations may apply.

Is Buteline Suitable for use with Re-circulated Hot Water Systems?*

**Buteline NZ Ltd will not advise installers on the suitability of their specific system, simply follow the flow chart below to gain your conclusion.*

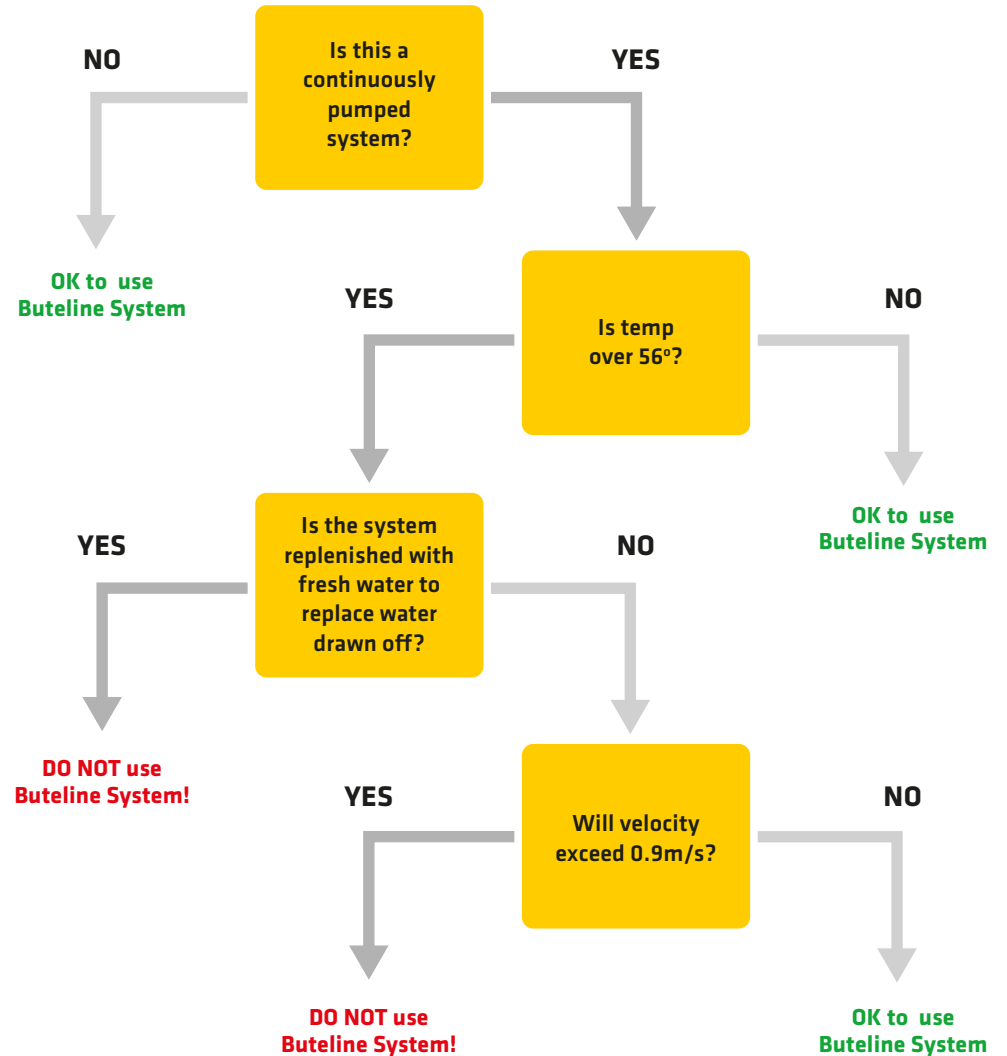

Non-Potable Water Piping

Lilac coloured Polybutene-1 pipe as per AS/NZS 2642 is to be used for non-potable water supplies, such as grey water, reclaimed water and stormwater retention tank applications.

Non-potable water typically supplies WC, laundry, and less frequently, outdoor hose taps. Check with your local authorities for correct applications.



Other Uses for the Buteline Plumbing System

If you wish to use the Buteline System outside of a normal potable water system (e.g. compressed air lines), please check with our Buteline technical representative for appropriate recommendations and installation instructions on 0800 BUTELINE before you proceed to install.

Installation Checklist

- ✓ Be methodical and check as you go that each joint has been clamped correctly.
- ✓ Check the pipe is clean and in good condition, with no kinks or scores.
- ✓ Check that pipework is “clipped” and supported.
- ✓ Check for expansion and contraction allowance on pipes.

Test The Installation

As with all installations, the Buteline Polybutene-1 plumbing system should be tested immediately after installation. Installations should be tested COLD.

- (a) 1500 kPa (220 P.S.I.) for 30 minutes (NZ Building Code & AS/NZS 3500.1) or 1035 kPa (150 P.S.I.) for 12 hours or overnight.
- (b) Set the hot water thermostat to a maximum of 60°C and check the hot water temperature (commissioning stage).

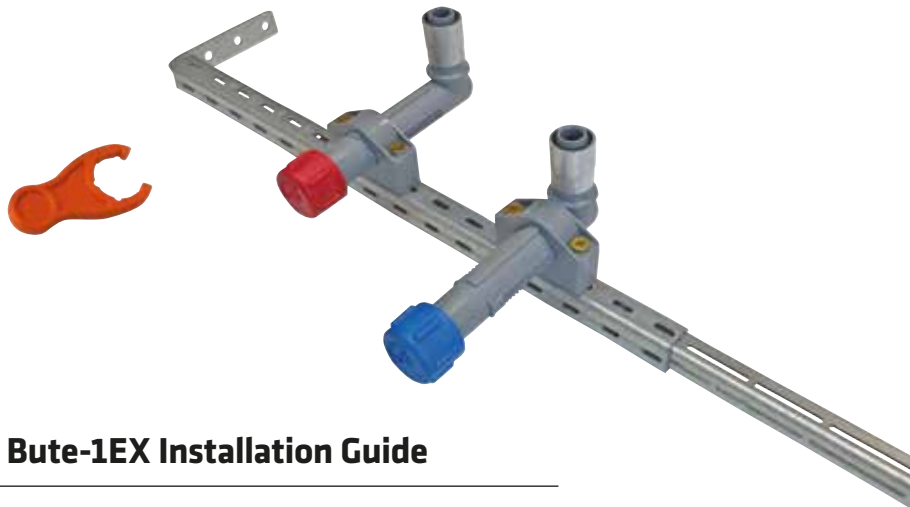

Bute-1 / Bute-1EX Installation Guide

Pipe Out Stage



1. Refer to the Installation Instructions for Telescopic Nog Brackets (page 54) to install the galvanized steel sliding brackets on timber wall studs or steel framing studs.

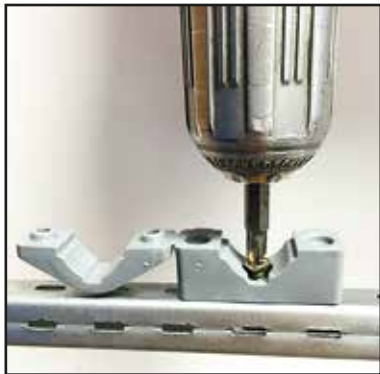

2. Use the supplied 15mm TEK screw (x 1) to fix the bottom of the Fixing Clamp to the desired position on the Telescopic Bracket.



IMPORTANT NOTE:

Allow minimum 150mm clearance from the end of the clamp ring to any pipe penetration to allow for free moment of the elbow when adjusting.



3. Insert the elbow into the Fixing Clamp, ensuring the inlet of the elbow is facing the desired direction.



The fixing clamp allows for 4 different fixing positions.

IMPORTANT NOTE:

Fix on top of the bracket OR Fix underneath the bracket



4. Fit the top half of the Fixing Clamp over the elbow. Drive the supplied 40mm TEK screws (x 2) into the bracket with a cordless drill, ensuring they are fully home.

NOTE: Set cordless drill to a medium torque setting, do not over-tighten.



5. Tighten (nip) the Bute self-sealing test cap with the Bute palm spanner supplied.

(No washers or thread tape etc. required).



6. Pull elbows into the fully forward (or otherwise desired) position.

Fit Off Stage



1. Remove the self-sealing test cap with the palm spanner and drain water.
2. Fit wall flange (if necessary) and then connect the appropriate fitting and do not overtighten.
3. Push back the adjustable male wall elbow until contact is made with the wall lining.

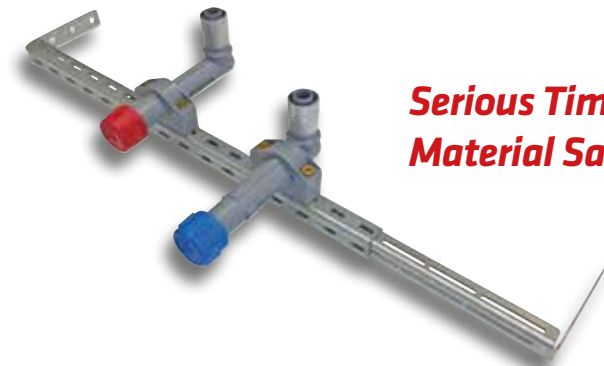

Serious Time and Material Savings!

Installation Guide for Telescopic Nog Brackets for BUTE-1, BUTE-1EX or Lugged Elbows

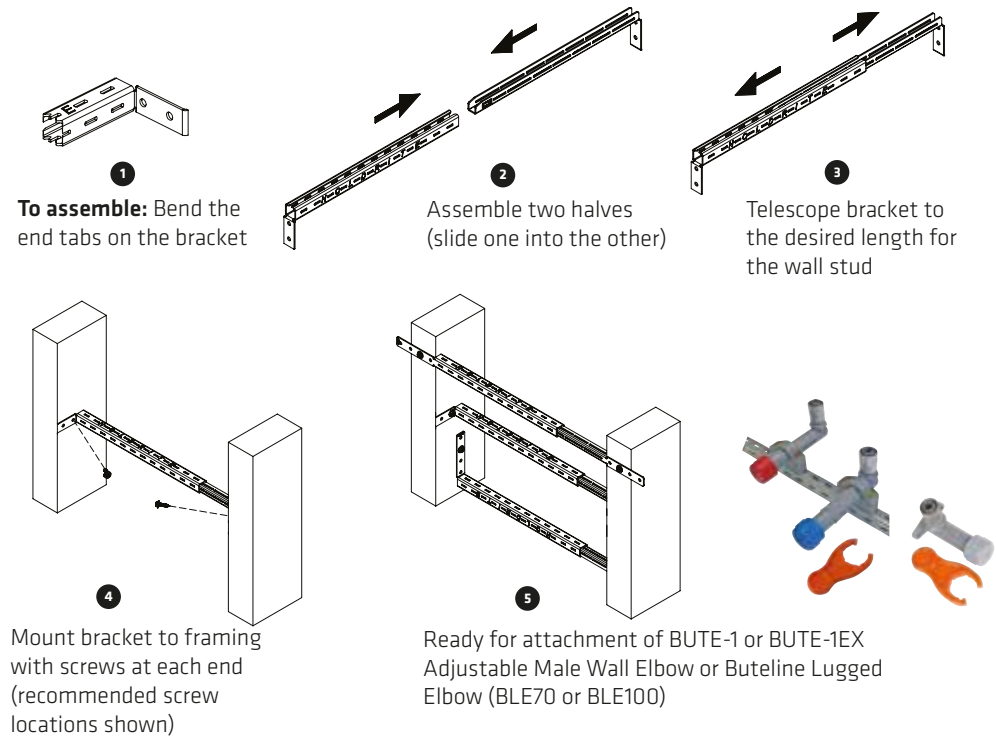

Product Code	Description	Stud Width Spacing
BK2	Telescopic Galvanized Steel Bracket	330mm to 610mm

1. Cut off any excess tabs or fold around stud.
2. Use appropriate industry standard hardware such as sheet metal screws or dry wall screws.
3. Failure to observe these instructions may lead to unsatisfactory product performance, which can result in property damage or bodily injury.

SAFETY INSTRUCTIONS:

Be mindful when adjusting the nogs to ensure hands are clear.

Installation Guide for Telescopic Nog Brackets

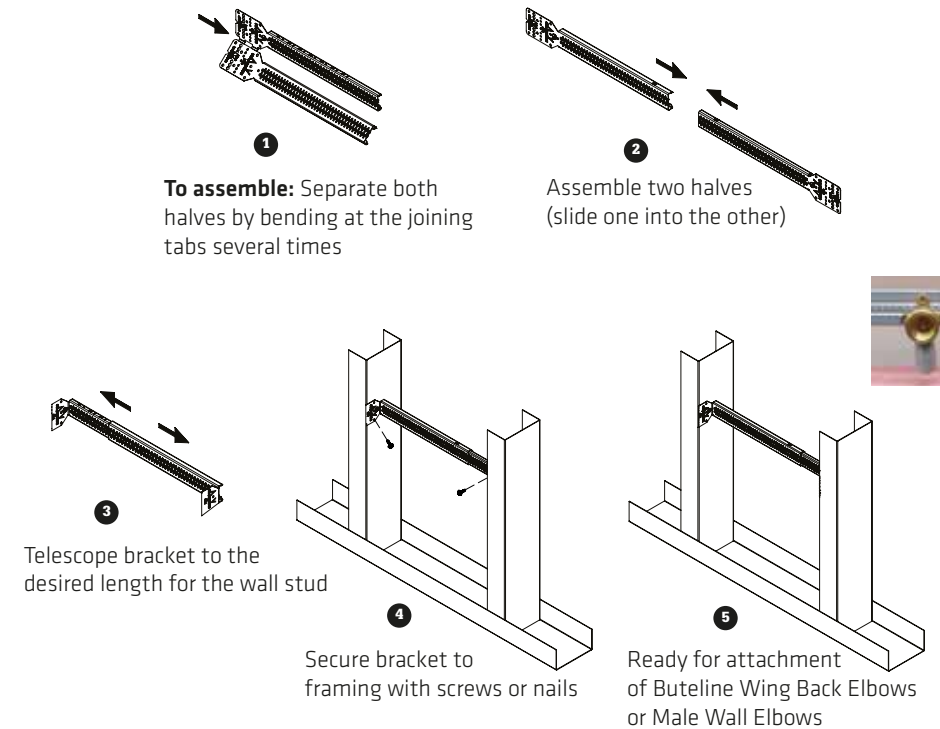

Product Code	Description	Stud Width Spacing
BK3	Telescopic Galvanized Steel Bracket	260mm to 400mm
BK4	Telescopic Galvanized Steel Bracket	355mm to 610mm

1. Cut off any excess tabs or fold around stud.
2. Use appropriate industry standard hardware such as sheet metal screws or dry wall screws.
3. Failure to observe these instructions may lead to unsatisfactory product performance, which can result in property damage or bodily injury.

SAFETY INSTRUCTIONS:

Be mindful when adjusting the nogs to ensure hands are clear.



A Hansgrohe iBox shower valve installed using BK4 brackets.

Typical Method Of Plumbing

Using Buteline PB-1 Water Mains As Shown

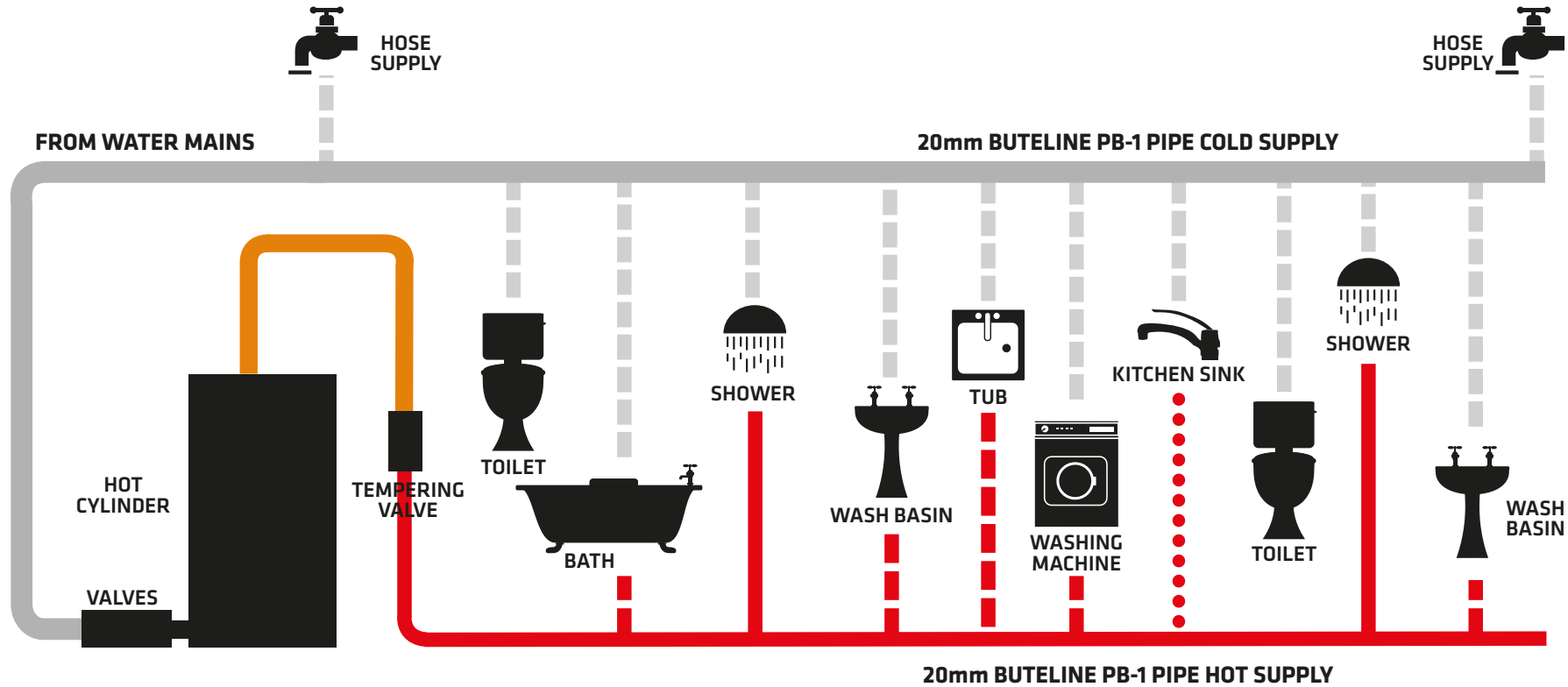

- 20mm BUTELINE PB-1 PIPE
- 15mm BUTELINE PB-1 PIPE
- 20mm BUTELINE RED PB-1 PIPE
- 15mm BUTELINE RED PB-1 PIPE
- 12mm BUTELINE RED PB-1 PIPE
(USE IF HOT WATER LINE IS OVER 12 MTS)
- COPPER PIPE

Acceptable Maximum Pipe Lengths (Water Heater to Kitchen Tap)		
Nominal Pipe Diameter	10mm (12mm)	15mm
Length	25m max	12m max

Where the pipeline supplying the kitchen sink tap is a combination of nominal bores the total volume of water in the pipe run shall not exceed 2 litres.

Acceptable Maximum Pipe Lengths (from Water Heater to Kitchen Tap)

N.Z.S 4305:1996 TABLE 5			
Acceptable Maximum Pipe Lengths (Water Heater to Kitchen Tap)			
Nominal pipe diameter	10mm (12mm)	15mm	20mm
Length	25m	12m	7m

Where the pipeline supplying the kitchen sink tap is a combination of nominal bores the total volume of water in the pipe run shall not exceed 2 litres.

- ✓ Reduced volume of water in the pipe = **hot water arrives much quicker** to the tap, and less water is wasted.
- ✓ Less energy wasted as less hot water sitting in the pipe after taps are closed.

PB-1 Pipe Volume for 12mm

Bute 12mm enables compliance with the efficiency requirements of NZS 4305:1996 Table 5 (shown above) as a 25 metre run of 12mm PB-1 pipe will hold 1.8L of water.

PB-1 Pipe Volume in Litres				
Length (m)	12mm	15mm	20mm	28mm
1	0.07	0.13	0.27	0.41
5	0.37	0.67	1.3	2.0
10	0.73	1.3	2.7	4.0
15	1.1	2.0	4.0	6.1
20	1.4	2.7	5.4	8.1
25	1.8	3.3	6.7	10.2

Definition Of Terms

Boiling Point

The boiling point refers to the temperature at which a liquid changes to vapour by the addition of heat.

The boiling point depends on the pressure at which the liquid is held.

Boiling point increases as the pressure increases.

Clamp

To brace, clasp or band for strengthening other materials. To strengthen or fasten to hold firmly. (Dictionary definition)

Crimp

To press into pleats or folds. (Dictionary definition)

Convection

Refers to the transfer of heat by means of a flow of fluid (liquid or gaseous form). Liquid is heated in one place then moved to a place where it can give up its heat. Natural convection is caused by heating a fluid making it less dense than the surrounding fluid and allowing the heated fluid to rise by displacement.

Crox Nut (NZ)

Use of a tapered copper section or olive with a lock seal nut.

Dezincification

When exposed to water many brasses show deterioration in which the zinc content is gradually removed – leaving a “spongy” copper which can become porous and leak. Some waters produce this effect very rapidly.

Underground Installation

Any installation where the product can come into direct contact with minerals, soil, or corrosive substances.

Marine Installation

Any installation where the product is prone to salt water exposure.

Design Stress Pressure

A design stress pressure is a factor used to calculate test pressure or safe working pressure.

A formula is used which incorporates wall thickness, pipe diameter and material characteristics to determine acceptable pressures.

i.e. Polybutene-1 design stress 1000 P.S.I. = test pressure 240 P.S.I. on 15mm pipe (PN 16 Type 18). Refer to Pressure Conversion Chart (page 64).

Limiting Valve

A pressure limiting valve. A form of pressure reducing valve which automatically reduces inlet water pressure to acceptable limits at the outlet – but only when supply pressure exceeds the pre-set minimum.

Potable

Drinkable water.

Tempering Valve

A valve which modifies hot water by adding cold water to produce water at a constant pre-set temperature.

T.P.R. (Temperature/Pressure Relief)

A fixed setting combination valve for temperature and pressure relief.

“Wet Back” (NZ)

“Back boiler”. Water coils behind a domestic fire or cooking range. Any fuel fired unit fitted with a coil or tank system which permits water to heat and flow by convection to a storage cylinder.

Project References



Charles Fleming Retirement Village, Waikanae, New Zealand



Jellicoe Avenue houses, Tuakau, New Zealand



D'Kayangan, Shah Alam, Selangor, Malaysia



C2 Esplanade Luxury Apartments, Darwin, Australia



New Capital Quay, Greenwich, London, United Kingdom



West End Gate, West London, United Kingdom



Wood Wharf, Canary Wharf, London, United Kingdom

Notes

Notes

Pressure Conversion Chart

kPa	Bar	Metre Head	P.S.I.
5	0.05	0.5	0.72
10	0.1	1	1.45
20	0.2	2	2.90
30	0.3	3	4.35
40	0.4	4	5.80
50	0.5	5	7.25
60	0.6	6	8.70
70	0.7	7	10.15
80	0.8	8	11.60
90	0.9	9	13.05
100	1.0	10	14.50
200	2.0	20	29.00
300	3.0	30	43.50
400	4.0	40	58.00
500	5.0	50	72.50
1000	10.0	100	145.00

(Rounded)

- 1 metre head = 3.28ft head
 - Additional conversions can be calculated.
- e.g. To find 700 kPa in bars or metre head from chart
- 500 kPa = 5 bar or 50 metre head
- + 200 kPa = 2 bar or 20 metre head
- = 700 kPa = 7 bar or 70 metre head

The Buteline 25 Year Warranty

To whom it may concern,

Buteline NZ Ltd ("Buteline") warrants that all products within the Buteline Plumbing System (including pipes and fittings) ("Buteline System") will be free from manufacturing defects for a period of 25 years from the date of manufacture ("Warranty") and that the Buteline System meets:

- The durability requirements of the New Zealand Building Code;
- The Australia/New Zealand joint standard AS/NZS 2642; and
- The standards set out in the Acceptable Solutions and Verification Methods G12 Water Supplies document (3rd edition, amendment 12) prepared by the Ministry of Business, Innovation & Employment.

This Warranty is strictly subject to the following terms and conditions.

Installation Requirements: Installation of the Buteline System must be carried out:

- By a licensed plumber;
- Strictly in accordance with the latest version available at the date of installation, of Buteline's Plumbers Technical & Installation Manual, which may be found at www.buteline.com/nz/buteline;
- In compliance with local and national plumbing regulations; and
- In accordance with the Acceptable Solutions and Verification Methods G12 Water Supplies document (3rd edition, amendment 12) prepared by the Ministry of Business, Innovation & Employment, including the requirement to use a suitable tempering valve for all hot water systems to be utilised for personal hygiene.

Exclusions: This Warranty does not apply if:

- The Installation Requirements set out above have not been met;
- The Buteline System has not been installed in a proper and workmanlike manner to the highest possible standard expected of a licensed plumber;
- The Buteline System has been installed in an incompatible or unsuitable environment where it is not fit for purpose, including if any system design is unsuitable;
- The Buteline System has not been used or maintained in accordance with Buteline's instructions;
- The Buteline System has been modified, incorrectly adjusted or operated; or
- The Buteline System has been subjected to corrosive or foreign solutions or chemicals (including highly chlorinated water that does not meet the standards set by the World Health Organisation) either internally within or externally around the Buteline System.

Consumer Guarantees Act: This Warranty is in addition to and does not exclude or limit a consumer's rights in relation to the Buteline System or its installation under the Consumer Guarantees Act 1993 (New Zealand).

Limitations: This Warranty is subject to the following limitations:

- Buteline's liability under this Warranty is limited to the cost of repairing or replacing the defective products within the Buteline System (at Buteline's discretion).
- Buteline will not be liable for the cost of any inspection, return, removal or reinstallation of any defective products or labour or other costs which may arise as a result of any claim under this Warranty.
- The Warranty only applies to pipes, fittings and joints within the Buteline System and does not extend to any other pipe, fitting or joint not made by Buteline or Pexline.
- Any claim under this Warranty must be made within 30 days of any potential claim being identified.
- Buteline does not in any way warrant the workmanship of any party that installs the Buteline System, nor does it warrant the system design incorporating the Buteline System by any party.
- This Warranty is only valid for products sold and installed in New Zealand, Asia and the Pacific.

Claims: To claim under this Warranty:

- Please contact Buteline at the following address: warranty@buteline.co.nz and send us the invoice for the products (as proof of purchase) and the installer's details, including their plumbing licence number.
- A Buteline representative will be in contact within 48 hours of receipt of your claim.
- Any products that are the subject of a claim cannot be destroyed or removed from the installation site until we have inspected the same or waived our right to do so in writing.

Disclaimer

This manual is only a general guide to the Buteline Plumbing System and cannot take into account the different circumstances of every application. The information contained in this manual is provided without any express, statutory or implied warranties. Neither the authors, Buteline, nor its partners or subsidiaries will be held liable for any damages caused or alleged to be caused either directly or indirectly by this manual.

This manual is subject to amendment by Buteline NZ Ltd and the latest available version is available from <https://www.buteline.com/nz>. The users of this manual should ensure that their copy is the latest version available before proceeding with any installation. Installation of Buteline components in accordance with an older version of the manual may invalidate any guarantee provided by Buteline NZ Ltd.

My Bute Representative is:

Name: _____

Phone: _____

Email: _____



Buteline NZ Limited

29 Lady Ruby Drive, East Tamaki, Auckland, New Zealand
PO Box 204308, Highbrook, Auckland 2161, New Zealand
Phone: +64 [0] 9 273 5800 Email: sales@buteline.co.nz

www.buteline.com