

UNO EXTENDED HEIGHT BASIN MIXER CURVED SPOUT - BLACK

43952.13
\$625

ELEMENTi

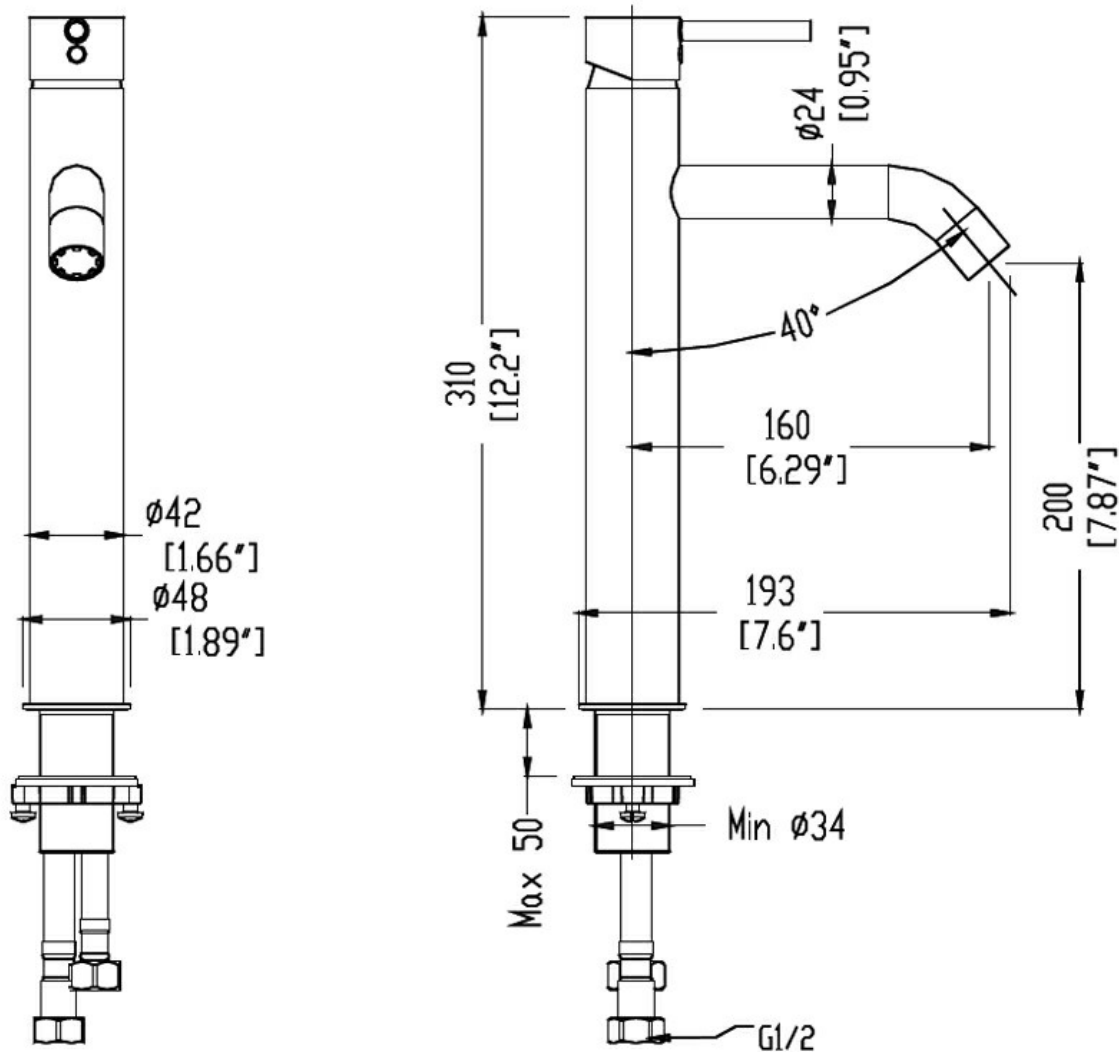

Residential/Light Commercial

Suitable for Residential/Light Commercial Use (Kitchens, Bathrooms and Laundries in Motels, Hotels and Retirement Villages)

10

Guarantee

10 Year Guarantee

5

Guarantee

5 Year Guarantee on coloured finish



5 Star WELS rating

More than 4.5 but not more than 6 litres per minute. Mains Pressure



6 Star WELS rating











More than 3 but not more than 4.5 litres per minute. Low/Unequal Pressure.



Mains Pressure

Suitable for Mains Pressure.



| | | |
|--|--|--|
|  | Multi Pressure | Suitable for Multi Pressure. |
|  | Flawless Finish | Advanced plating provides a durable surface with a long lasting finish |
|  | Effortless Control | Advanced cartridge technology provides a wide operating angle and smooth operation |
|  | Smooth Flow | Aerator reduces scaling while delivering a smooth even flow |
|  | Indicators | Includes both colour & full black indicators. |
|  | Chrome Plate | A base of copper is first applied followed by a layer of nickel and then finally a hard gloss coating of chromium to achieve a shiny hard wearing finish. |
|  | Blackened Oil Bronze: Black | Parts are firstly nickel plated then blackened oxidation process to apply the base colour. and a transparent liquid polymer is applied achieve a mat finish and hardened surface. |
|  | Electroplated: Gun Metal | Electrical current is used to dissolve components into Lacquer that then adhere to the surface. |
|  | Electroplated with PVD: Brushed Nickel | Electrical current is used to dissolve components into Lacquer that then adhere to the surface. A thin metal-spray coating in the form of very thin layers is finally applied using PVD process. |
|  | Electroplated with PVD: Brushed Brass | Electrical current is used to dissolve components into Lacquer that then adhere to the surface. A thin metal-spray coating in the form of very thin layers is finally applied using PVD process. |

The Uno collection offers a glamorous look without being too ostentatious. After years of chrome dominating as the must-have metal, there has been a move away from the high shine, perfect finish of Chrome towards finishes like Brushed Nickel, Gun Metal, Black and Brushed Brass.