

KOHA BASIN MIXER

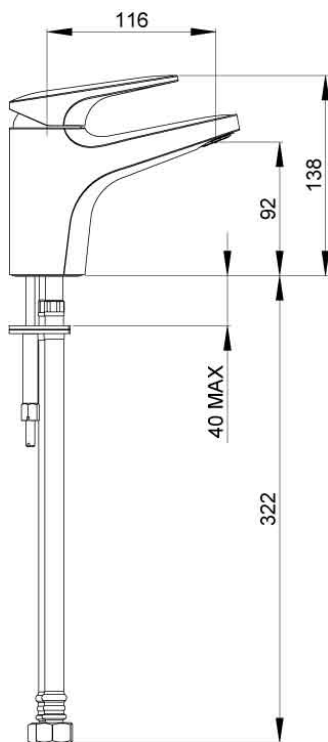

CONSTRUCTION: Brass body

CARTRIDGE: Ceramic

CLASSIFICATION: Suitable for **all pressure** systems

INLET CONNECTIONS: 1/2" BSP Female

WORKING PRESSURE: 35 - 1000kPa

DIMENSIONS FOR FITTING: 35 - 38mm diameter hole

OPERATING TEMPERATURE: 5 °C - 80 °C

WATERFLOW RATE: 6.5 l/m

- Swivels at the base, with optional base ring
- Maximal bench thickness of 40mm
- Slim stream shape aerator with directional swivel
- Stainless steel flexible inlet hoses
- Dezincification Resistant brass body for greater durability and safe water
- Twin stud mounting kit for hassle free installation
- 4 star WELS rated on mains pressure (6.5 l/m)
- 4 star WELS rated on low pressure (7.0 l/m)

KOBSLCP

Chrome

<http://www.methven.com/nz/koha-swivel-basin-mixer>