

# HITACHI

**SPLIT TYPE AIR CONDITIONER**

## INDOOR UNIT/OUTDOOR UNIT



### MODEL

**RAS-E50YHA / RAC-E50YHA  
RAS-E60YHA / RAC-E60YHA**

#### INDOOR UNIT

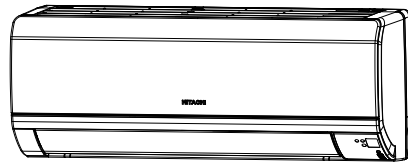

RAS-E50YHA  
RAS-E60YHA

#### OUTDOOR UNIT

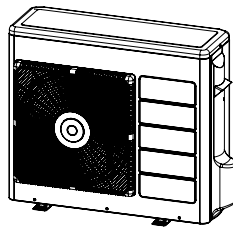

RAC-E50YHA  
RAC-E60YHA

#### Instruction manual

To obtain the best performance, please read this instruction manual completely.

Page 1~24



# SAFETY PRECAUTION

- Please read the "Safety Precaution" carefully before operating the unit to ensure correct usage of the unit.
- Pay special attention to signs of "▲ Warning" and "▲ Caution". The "Warning" section contains matters which, if not observed strictly, may cause death or serious injury. The "Caution" section contains matters which may result in serious consequences if not observed properly. Please observe all instructions strictly to ensure safety.
- The sign indicate the following meanings.

	Make sure to connect earth line.		The sign in the figure indicates prohibition.
	Indicates the instructions that must be followed.		

	<b>WARNING</b>	This symbol shows that this equipment uses a flammable refrigerant. If the refrigerant is leaked, together with an external ignition source, there is a possibility of ignition.
	<b>CAUTION</b>	This symbol shows that the Operation Instructions should be read carefully.
	<b>CAUTION</b>	This symbol shows that a service personnel should be handling this equipment with reference to the Installation Manual.
	<b>CAUTION</b>	This symbol shows that there is information included in the Operation Manual and/or Installation Manual

- Please keep this manual after reading.

## PRECAUTIONS DURING INSTALLATION

	<b>WARNING</b>	<ul style="list-style-type: none"> <li>• Do not reconstruct the unit. Water leakage, fault, short circuit or fire may occur if you reconstruct the unit by yourself.</li> </ul>	
		<ul style="list-style-type: none"> <li>• Please ask your sales agent or qualified technician for the installation of your unit. Water leakage, short circuit or fire may occur if you install the unit by yourself.</li> </ul>	
	<b>WARNING</b>	<ul style="list-style-type: none"> <li>• Please use earth line. Do not place the earth line near water or gas pipes, lightning-conductor, or the earth line of telephone. Improper installation of earth line may cause electric shock.</li> </ul>	
		<ul style="list-style-type: none"> <li>• Be sure to use the specified piping set for R32. Otherwise, this may result in broken copper pipes or faults.</li> </ul>	
		<ul style="list-style-type: none"> <li>• Do not use refrigerant other than the one indicated on the outdoor unit (R32) when installing, moving or repairing. Using other refrigerants may cause trouble or damage to the unit, and personal injury.</li> </ul>	
	<b>CAUTION</b>	<ul style="list-style-type: none"> <li>• A circuit breaker should be installed depending on the mounting site of the unit. Without a circuit breaker, the danger of electric shock exists.</li> </ul>	
		<ul style="list-style-type: none"> <li>• Do not install near location where there is flammable gas. The outdoor unit may catch fire if flammable gas leaks around it.</li> </ul>	
		<ul style="list-style-type: none"> <li>• Please ensure smooth flow of water when installing the drain hose.</li> <li>• Do not install the indoor unit in a machine shop or kitchen where vapor from oil or its mist flows to the indoor unit. The oil will deposit on the heat exchanger, thereby reducing the indoor unit performance and may deform and in the worst case, break the plastic parts of the indoor unit.</li> </ul>	

## PRECAUTIONS DURING SHIFTING OR MAINTENANCE

	<b>WARNING</b>	<ul style="list-style-type: none"> <li>• Should abnormal situation arises (like burning smell), please stop operating the unit and turn off the circuit breaker. Contact your agent. Fault, short circuit or fire may occur if you continue to operate the unit under abnormal situation.</li> </ul>	
		<ul style="list-style-type: none"> <li>• Please contact your agent for maintenance. Improper self maintenance may cause electric shock and fire.</li> </ul>	
		<ul style="list-style-type: none"> <li>• Please contact your agent if you need to remove and reinstall the unit. Electric shock or fire may occur if you remove and reinstall the unit yourself improperly.</li> </ul>	
		<ul style="list-style-type: none"> <li>• If the supply cord is damaged, it must be replaced by the special cord obtainable at authorized service/parts centers.</li> </ul>	

## PRECAUTIONS DURING OPERATION

	<b>WARNING</b>	<ul style="list-style-type: none"> <li>• Avoid an extended period of direct air flow for your health.</li> </ul>	
		<ul style="list-style-type: none"> <li>• Do not insert a finger, a rod or other objects into the air outlet or inlet. As the fan is rotating at a high speed, it will cause injury. Before cleaning, be sure to stop the operation and turn the breaker OFF.</li> </ul>	
		<ul style="list-style-type: none"> <li>• Do not use any conductor as fuse wire, this could cause fatal accident.</li> </ul>	
		<ul style="list-style-type: none"> <li>• During thunder storm, disconnect and turn off the circuit breaker.</li> </ul>	
		<ul style="list-style-type: none"> <li>• Spray cans and other combustibles should not be located within a meter of the air outlets of both indoor and outdoor units. As a spray can's internal pressure can be increased by hot air, a rupture may result.</li> </ul>	

## PRECAUTIONS DURING OPERATION

- The product shall be operated under the manufacturer specification and not for any other intended use.



- Do not attempt to operate the unit with wet hands, this could cause fatal accident.

- When operating the unit with burning equipments, regularly ventilate the room to avoid oxygen insufficiency.



- Do not direct the cool air coming out from the air-conditioner panel to face household heating apparatus as this may affect the working of apparatus such as the electric kettle, oven etc.

- Please ensure that outdoor mounting frame is always stable, firm and without defect. If not, the outdoor unit may collapse and cause danger.



- Do not splash or direct water to the body of the unit when cleaning it as this may cause short circuit.

- Do not use any aerosol or hair sprays near the indoor unit. This chemical can adhere on heat exchanger fin and blocked the evaporation water flow to drain pan. The water will drop on tangential fan and cause water splashing out from indoor unit.



- Please switch off the unit and turn off the circuit breaker during cleaning, the high-speed fan inside the unit may cause danger.

- Turn off the circuit breaker if the unit is not to be operated for a long period.



- Do not climb on the outdoor unit or put objects on it.

- Do not put water container (like vase) on the indoor unit to avoid water dripping into the unit. Dripping water will damage the insulator inside the unit and causes short-circuit.

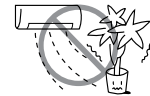
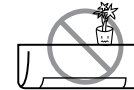

- Do not place plants directly under the air flow as it is bad for the plants.

- When operating the unit with the door and windows opened, (the room humidity is always above 80%) and with the air deflector facing down or moving automatically for a long period of time, water will condense on the air deflector and drips down occasionally. This will wet your furniture. Therefore, do not operate under such condition for a long time.

- If the amount of heat in the room is above the cooling or heating capability of the unit (for example: more people entering the room, using heating equipments and etc.), the preset room temperature cannot be achieved.

- This appliance can be used by children aged from 8 years and above and persons with reduced physical, sensory or mental capabilities or lack of experience and knowledge if they have been given supervision or instruction concerning use of the appliance in a safe way and understand the hazards involved. Children shall not play with the appliance. Cleaning and user maintenance shall not be made by children without supervision.

CAUTION

## NAMES AND FUNCTIONS OF EACH PART

### INDOOR UNIT

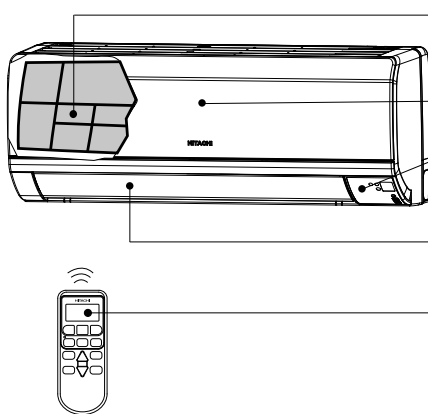

**Pre-filter**

To prevent dust from coming into the indoor unit.  
(Refer page 20)

**Front panel**

**Indoor unit indicators**

Light indicator showing the operating condition.  
(Refer page 5)

**Horizontal deflector • Vertical deflector  
(Air Outlet)**

(Refer page 15)

**Remote controller**

Send out operation signal to the indoor unit. So as to operate the whole unit.  
(Refer page 6)

### OUTDOOR UNIT

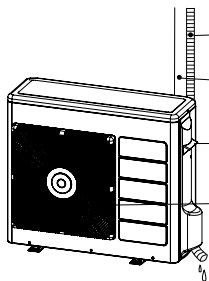

**Drain pipe**

Condensed water drain to outside.

**Connecting cord and insulation pipe for piping**

**Air inlet (Back, Left side)**

**Air outlet**

**CAUTION**

- When heating operation, drain or defrosted water flows out from outdoor unit. Don't close drain outlet portion in chilly area so as not to freeze these.

### MODEL NAME AND DIMENSIONS

MODEL	WIDTH (mm)	HEIGHT (mm)	DEPTH (mm)
RAS-E50YHA, RAS-E60YHA	900	300	229
RAC-E50YHA, RAC-E60YHA	850	750	298



## INDOOR UNIT INDICATORS

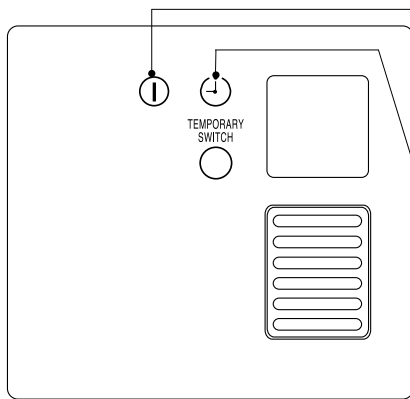

### OPERATION LAMP

This lamp lights during operation. The OPERATION LAMP flashes/dimming in the following cases during heating.

#### (1) During preheating

For about 2–3 minutes after starting up.

#### (2) During defrosting

Defrosting will be performed about once every one hour when frost forms on the heat exchanger of the outdoor unit, for 5–10 minutes each time.

### TIMER LAMP

This lamp lights when the timer is working.

## OPERATION INDICATOR

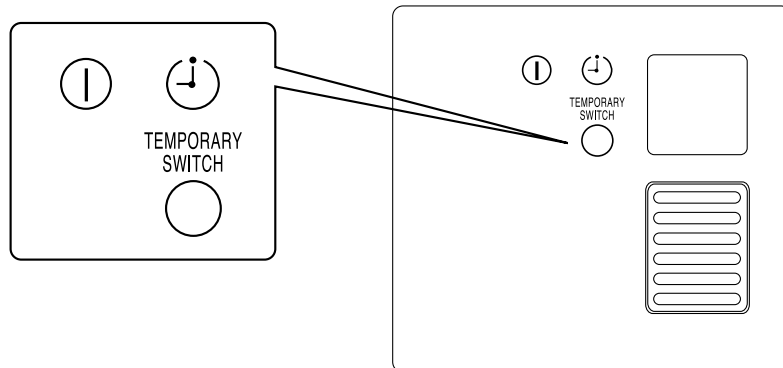

### TEMPORARY SWITCH

Use this switch to start and stop when the remote controller does not work.

- By pressing the temporary switch, the operation is done in automatic operation mode.
- When the operation is done using the temporary switch after the power source is turned off and turn on again, the operation is done in automatic mode.

## NAMES AND FUNCTIONS OF EACH PART

### REMOTE CONTROLLER

- This controls the operation of the indoor unit.  
The signal range of control is about 7 meters. If inverter lamp is used, the range of control may be shorter, in some cases, the control signal may not be received.  
This unit can be fixed on a wall using the fixture provided. Before fixing it, make sure the indoor unit can be controlled from the remote controller.
- Handle the remote controller with care.  
Dropping it or getting it wet may compromise its signal transmission capability.
- After new batteries are inserted into the remote controller, the unit will initially require approximately 10 seconds to respond to commands and operate.

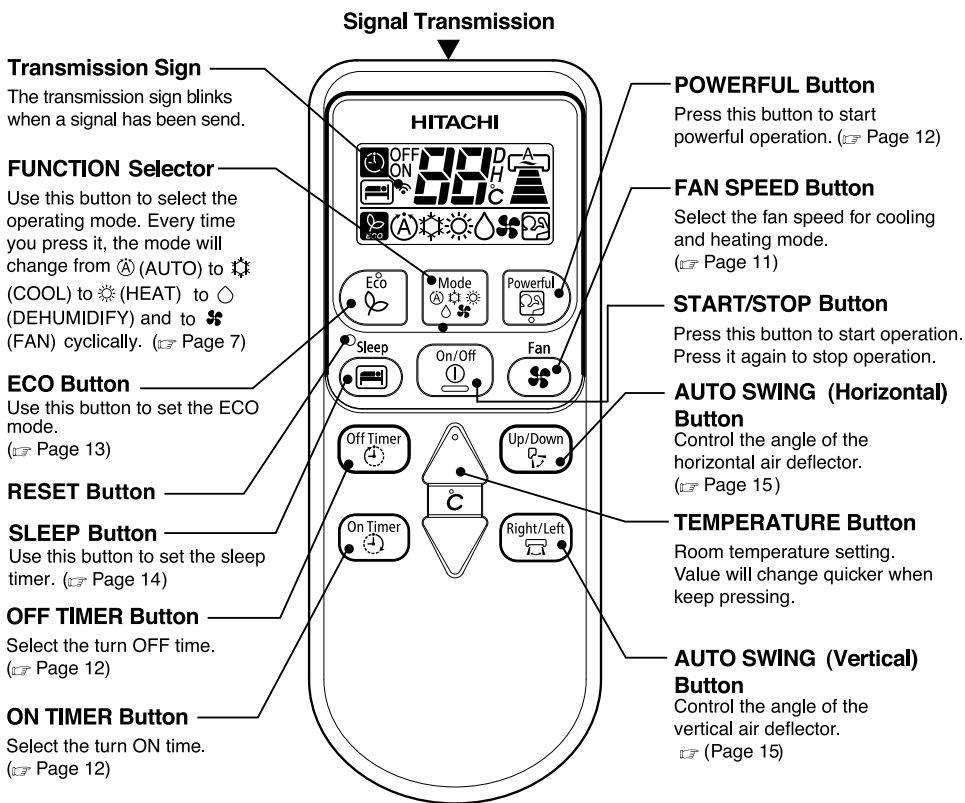

### Precautions for Use

- Do not put the remote controller in the following places.
  - In direct sunlight
  - In the vicinity of a heater.
- Handle the remote controller carefully. Do not drop it on the floor, and protect it from water.
- Once the outdoor unit stops, it will not restart for about 3 minutes (unless you turn the power switch off and on or unplug the power cord and plug it in again).  
This is to protect the device and does not indicate a failure.
- If you press the FUNCTION selector button during operation, the device may stop for about 3 minutes for protection.

## VARIOUS FUNCTIONS

### ■ Auto Restart Control

- If there is a power failure, operation will be automatically restarted when the power is resumed with previous operation mode and airflow direction.  
(As the operation is not stopped by remote controller.)
- If you intend not to continue the operation when the power is resumed, switch off the power supply. When you switch on the circuit breaker, the operation will be automatically restarted with previous operation mode and airflow direction.

Note: 1. If you do not require Auto Restart Control, please consult your sales agent.  
2. Auto Restart Control is not available when Timer or Sleep Timer mode is set.

## AUTOMATIC OPERATION

The device will automatically determine the mode of operation, HEAT or COOL depending on the current room temperature. The selected mode of operation will change when the room temperature varies. However, the mode of operation will not change when indoor unit is connected to multi type outdoor unit.

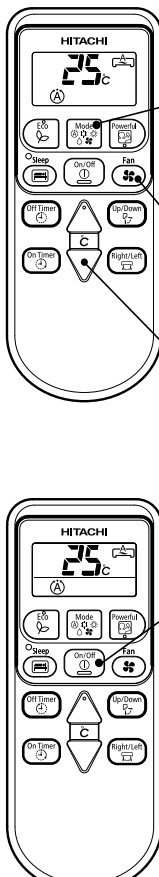

**1** Press the MODE selector button so that the display indicates the  (AUTO) mode of operation.

- When AUTO has been selected, the device will automatically determine the mode of operation, HEAT or COOL depending on the current room temperature. However the mode of operation will not change when indoor unit is connected to multi type outdoor unit.
- If the mode automatically selected by the unit is not satisfactory, manually change the mode setting (HEAT, DEHUMIDIFY, COOL or FAN).

**2** Set the desired FAN SPEED with the  (FAN SPEED) button (the display indicates the setting).

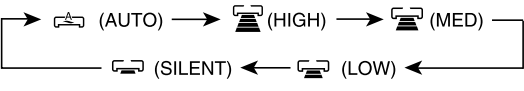

**3** Set the desired room temperature with the TEMPERATURE buttons (the display indicates the setting).  
The temperature setting and the actual room temperature may vary depending on conditions.

**START STOP** Press the  (START/STOP) button.  
Operation starts with a beep.  
Press the button again to stop operation.

- As the settings are stored in the memory of the remote controller, you only have to press the  (START/STOP) button next time.

Press the  (FAN SPEED) button to select AUTO, HIGH, MED, LOW or SILENT.

## HEATING OPERATION

- Use the device for heating when the outdoor temperature is under 27°C. When it is too warm (over 27°C), the heating function may not work in order to protect the device.
- In order to keep reliability of the device, please use this device above -15°C of the outdoor temperature.

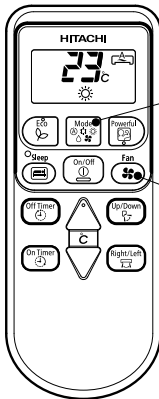

**1** Press the FUNCTION selector so that the display indicates ☀ (HEAT).

Set the desired FAN SPEED with the 🌀 (FAN SPEED) button (the display indicates the setting).

🌀 (AUTO) : The fan speed changes automatically according to the temperature of the air which blows out.

🔥 (HI) : Economical as the room will become warm quickly. But you may feel a chill at the beginning.

🔊 (MED) : Quiet.

🔊 (LOW) : More quiet.

🔊 (SILENT) : Silent.

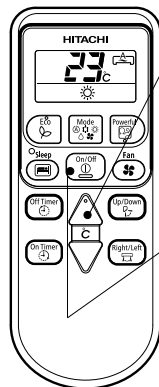

**3** Set the desired room temperature with the TEMPERATURE buttons (the display indicates the setting).

The temperature setting and the actual room temperature may vary somewhat depending on conditions.

**START STOP** Press the ⏻ (START/STOP) button. Heating operation starts with a beep. Press the button again to stop operation.

- As the settings are stored in memory in the remote controller, you only have to press the ⏻ (START/STOP) button next time.

### ■ Defrosting

Defrosting will be performed about once an hour when frost forms on the heat exchange of the outdoor unit, for 5~10 minutes each time.

During defrosting operation, the operation lamp blinks in cycle of 3 seconds on and 0.5 second off.

The maximum time for defrosting is 20 minutes.

(If the piping length used is longer than usual, frost will likely to form.)

## DEHUMIDIFYING OPERATION

Use the device for dehumidifying when the room temperature is over 16°C.  
When it is under 15°C, the dehumidifying function will not work.

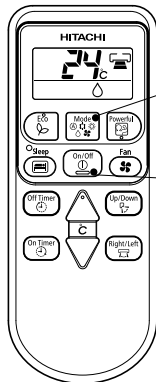

1 Press the FUNCTION selector so that the display indicates ◯ (DEHUMIDIFY).  
Press the  (FAN SPEED) button to select LOW and SILENT.

**START STOP** Press the  (START/STOP) button.

- When you want to change the operation mode, please use the FUNCTION selector.
- Set the desired temperature is available.
- You also can use the FUNCTION selector to select this operation.

### ■ Dehumidifying Function

- Dehumidifying takes place with a target temperature which is slightly lower than the room temperature setting. (However, target temperature is 16°C for a temperature setting of 16°C.) If the room temperature becomes lower than the target value, operation stops. If the room temperature becomes higher than the target value, operation restarts.
- The preset room temperature may not be reached depending on the number of people present in the room conditions.

## COOLING OPERATION



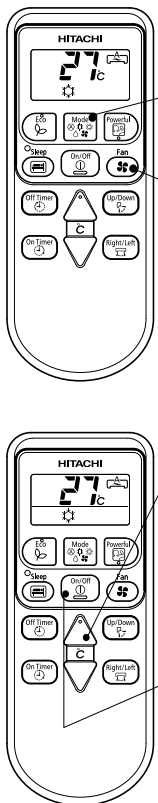

Use the device for cooling when the outdoor temperature is -10 to 46°C.  
If humidity is very high (over 80%) indoors, some dew may form on the air outlet grille of the indoor unit.



**1** Press the FUNCTION selector so that the display indicates  (COOL).

Set the desired FAN SPEED with the  (FAN SPEED) button (the display indicates the setting).

**2**



-  (AUTO) : The FAN SPEED is HI at first and varies to MED automatically when the preset temperature has been reached.
-  (HI) : Economical as the room will become cool quickly.
-  (MED) : Quiet.
-  (LOW) : More quiet.
-  (SILENT) : Silent.

Set the desired room temperature with the TEMPERATURE buttons (the display indicates the setting).

**3**

The temperature setting and the actual room temperature may vary somewhat depending on conditions.

**START STOP**

Press the  (START/STOP) button. Cooling operation starts with a beep. Press the button again to stop operation. The cooling function does not start if the temperature setting is higher than the current room temperature (even though the  (OPERATION) lamp lights).  
The cooling function will start as soon as you set the temperature below the current room temperature.

■ As the settings are stored in memory in the remote controller, you only have to press the  (START/STOP) button next time.

## FAN OPERATION

You can use the device simply as an air circulator. Use this function to dry the interior of the indoor unit at the end of summer.

**1** Press the FUNCTION selector so that the display indicates (FAN).

**2** Press the (FAN SPEED) button.

(HI) : The strongest air blow.  
 (MED) : Quiet.  
 (LOW) : More quiet.  
 (SILENT): Silent.

**START/STOP** Press the (START/STOP) button. Fan operation starts with a beep. Press the button again to stop operation.

**FAN SPEED (AUTO)** ... When the AUTO fan speed mode is set in the cooling/heating operation:

For the heating operation	<ul style="list-style-type: none"> <li>• The fan speed will automatically change according to the temperature of discharged air.</li> <li>• As room temperature reaches the preset temperature, a very light breeze will blow.</li> </ul>
For the cooling operation	<ul style="list-style-type: none"> <li>• Operation starts in the "HI" mode to reach the preset temperature.</li> <li>• As room temperature approaches the preset temperature, fan speed automatically switches to "LOW".</li> </ul>

## TIMER RESERVATION

- ON Timer and OFF Timer are available.

### Timer Reservation

- Operation stop at setting time

- 1 OFF TIME setting**
- Select the OFF TIME by pressing the  (OFF) Button.
  - Setting time will change according to the below sequence when you press the button.

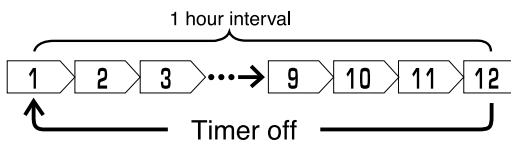

- 2 ON TIME setting**
- Select the ON TIME by pressing the  (ON) Button.
  - Setting time will change according to the below sequence when you press the button.

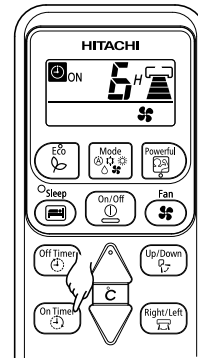
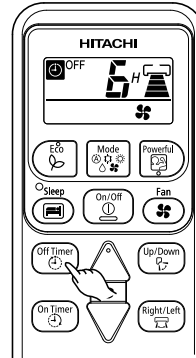
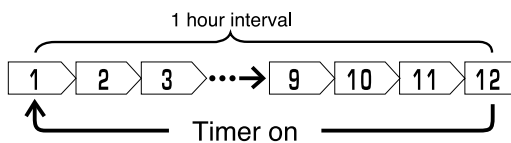

## POWERFUL OPERATION

- By pressing  (POWERFUL) button during HEATING, DEHUMIDIFYING, COOLING, FAN, AUTOMATIC operation, the air conditioner performs at maximum power.
- During POWERFUL operation, cooler or warmer air will be blown out from indoor unit for COOLING or HEATING operation respectively.

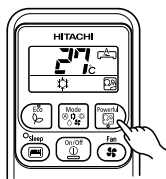



### START

Press the  (POWERFUL) button during operation.

- "  " is displayed on the LCD.
- POWERFUL operation ends in 20 minutes. Then the system automatically operates with the previous settings used before POWERFUL operation.

### CANCEL

- Press the  (START/ STOP) button, or
- Press the  (POWERFUL) button again.
- "  " disappears from the LCD.

### NOTE

- When ECO mode is selected, POWERFUL operation is cancelled.
- During POWERFUL operation, capacity of the air conditioner will not increase
  - if the air conditioner is already running at maximum capacity.
  - just before defrost operation (when the air conditioner is running in HEATING operation).
- After auto restart, POWERFUL operation is cancelled and previous operation shall start.



## ECO OPERATION

- Energy saving operation by changing set temperature and by limiting the maximum power consumption value.

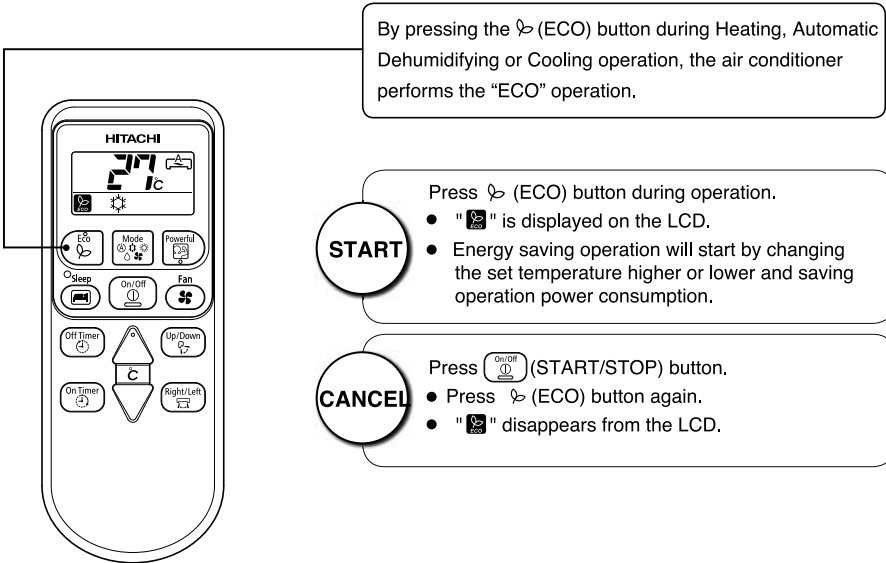

By pressing the  (ECO) button during Heating, Automatic Dehumidifying or Cooling operation, the air conditioner performs the "ECO" operation.



**START**

Press  (ECO) button during operation.

- "  " is displayed on the LCD.
- Energy saving operation will start by changing the set temperature higher or lower and saving operation power consumption.

**CANCEL**

Press  (START/STOP) button.

- Press  (ECO) button again.
- "  " disappears from the LCD.

### NOTE

- In case the power consumption is already low, ECO operation will not reduce the power consumption.
- By pressing (POWERFUL) button, ECO operation is cancelled.
- After auto restart, ECO operation is cancelled and previous operation mode shall start.

## HOW TO SET THE SLEEP TIMER

By pressing  (SLEEP) button during AUTO, HEATING, DEHUMIDIFYING, COOLING or FAN operation, the unit shifts the room temperature and reduces the fan speed.

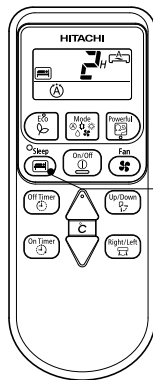

● SLEEP

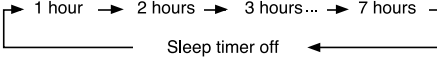

Mode	Indication
Sleep Timer	

**Sleep Timer:** The device will continue working for the desired number of hours and then turn off.  
Point the signal window of the remote controller toward the indoor unit, and press the SLEEP button.  
The timer information will be displayed on the remote controller. The TIMER lamp lights with a beep from the indoor unit.

To cancel SLEEP TIMER operation.

Press  (START/STOP) button.

- Room air conditioner will switch off.

Press  (SLEEP) button again until off time, "" and number of hour disappear from the remote controller display.

- A beep sound emitted from indoor unit and the (TIMER) lamp on the indoor unit turns off.
- SLEEP TIMER operation is cancelled.

### NOTE

- If you set the sleep timer when the off-timer or on-timer has been set earlier, the sleep timer becomes effective instead of the off-timer or on-timer.
- The indoor fan speed of air conditioner does not change even when fan speed button is pressed.

## ADJUSTING THE AIR DEFLECTORS

- 1** Adjustment of the conditioned air in the upward and downward directions.  
The horizontal air deflector is automatically set to the proper angle suitable for each operation. The deflector can be swung up and down continuously and also set to the desired angle using the “Up/Down” (AUTO SWING(HORIZONTAL)) button.

- If the “Up/Down” (AUTO SWING(HORIZONTAL)) button is pressed once, the horizontal air deflector swings up and down. If the button is pressed again, the deflector stops in its current position. Several seconds (about 6 seconds) may be required before the deflector starts to move.
- Use the horizontal air deflector within the adjusting range shown in the right.
- When the operation is stopped, the horizontal air deflector moves and stops at the position where the air outlet closes.

### CAUTION

- In “Cooling” operation, do not keep the horizontal air deflector swinging for a long time. Some dew may form on the horizontal air deflector and dew may drop.

- 2** Adjustment of the conditioned air to the left and right.

- If the “Right/Left” (AUTO SWING(VERTICAL)) button is pressed once, the deflectors will start to swing right and left. If the button is pressed again, the deflector will stop in the current position. Several seconds (about 6 seconds) may be required before the deflector starts to move.

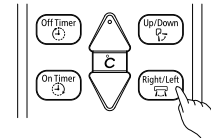
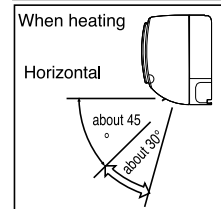
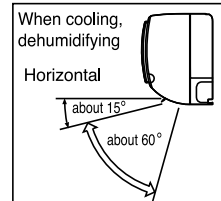
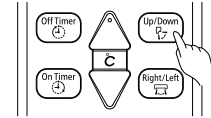

### WARNING

Do not insert a finger, a rod or other objects into the air outlet or inlet as the fan is rotating at a high speed, it will cause injury. Before any cleaning or adjusting the deflectors, be sure to switch OFF the operation.

## HOW TO EXCHANGE THE BATTERIES IN THE REMOTE CONTROLLER

**1** Remove the cover as shown in the figure and take out the old batteries.



**2** Install the new batteries.  
The direction of the batteries should match the marks in the case.

### **CAUTION**

1. Do not use new and old batteries, or different kinds of batteries together.
2. Take out the batteries when you do not use the remote controller for 2 or 3 months.
3. Use high quality and high performance AAA batteries to avoid short operating life and electrolyte leakages.

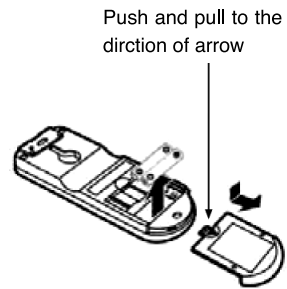

## THE IDEAL WAYS OF OPERATION

### Suitable Room Temperature

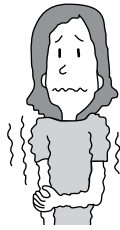

**Warning**  
Freezing temperature is bad for health and a waste of electric power.

### Install curtain or blinds

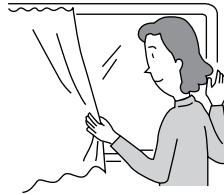

It is possible to reduce heat entering the room through windows.

### Ventilation

**Caution**  
Do not close the room for a long period of time. Occasionally open the door and windows to allow the entrance of fresh air.



### Effective Usage Of Timer

At night, please use the "OFF or ON timer operation mode", together with your wake up time in the morning. This will enable you to enjoy a comfortable room temperature. Please use the timer effectively.

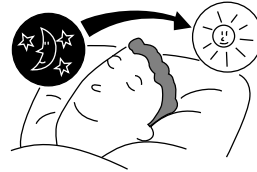

### Do Not Forget To Clean The Pre-Filter

Dusty pre-filter will reduce the air volume and the cooling efficiency. To prevent from wasting electric energy, please clean the filter every 2 weeks.

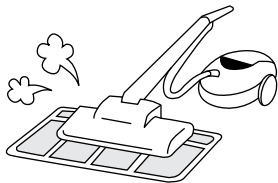

### Please Adjust Suitable Temperature For Baby And Children

Please pay attention to the room temperature and air flow direction when operating the unit for baby, children and old folks who have difficulty in movement.

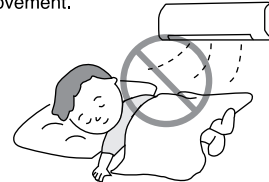

## FOR USER'S INFORMATION

### The Air Conditioner And The Heat Source In The Room

#### ⚠ Caution

If the amount of heat in the room is above the cooling capability of the air conditioner (for example: more people entering the room, using heating equipments and etc.), the preset room temperature cannot be achieved.

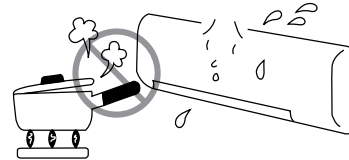

### Not Operating For A Long Time

When the indoor unit is not to be used for a long period of time, please switch off the power from the mains. If the power from mains remains "ON", the indoor unit still consumes about 3W in the operation control circuit even if it is in "OFF" mode.

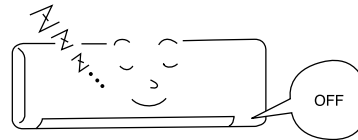

### When Lightning Occurs

#### ⚠ Warning

To protect the whole unit during lightning, please stop operating the unit and remove the plug from the socket.

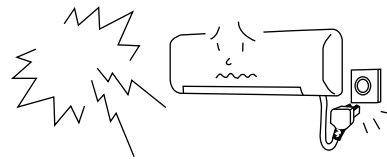

### Interference From Electrical Products

#### ⚠ Caution

To avoid noise interference, please place the indoor unit and its remote controller at least 1m away from electrical products.

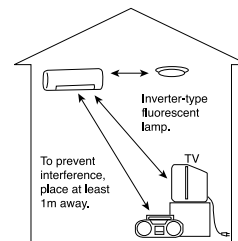

## ATTACHING THE AIR PURIFYING FILTERS

- 1** **Open the front panel**
- Pull up the front panel by holding it at both sides with both hands.

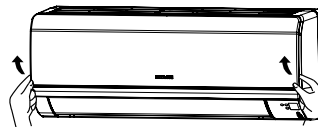

- 2** **Remove the Pre-filter**
- Push upward to release the claws and pull out the Pre-filter.

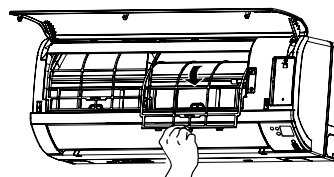

- 3** **Attaching the air purifying filters**
- Attach the air purifying filters to the frame by gently compress its both sides and release after insertion into Pre-filter frame.

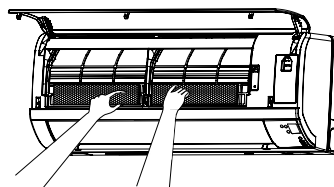

**CAUTION**

Do not bend the air purifying filter as it may cause damage to the structure.

Please do not smell direct from source of filter.

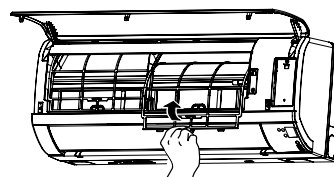

- 4** **Attach the Pre-filters**
- Attach the Pre-filters by ensuring that the surface written "FRONT" is facing front.
  - After attaching the Pre-filters, push the front panel at three arrow portions as shown in figure and close it.

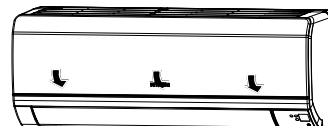

### NOTE

- In case of removing the air purifying filters, please follow the above procedures.
- The cooling capacity is slightly weakened and the cooling speed becomes slower when the air purifying filters are used. So, set the fan speed to "HIGH" when using it in this condition.
- Air purifying filters are not washable. It is recommended to use vacuum to clean it. It can be used for 1 year time. Type number for this air purifying filter is <SPX-CFH22>. Please use this number for ordering when you want to renew it.
- Do not use detergent on the air purifying filter as some detergent may deteriorate the air purifying filter electrostatic performance.

## MAINTENANCE

### ⚠ CAUTION

Cleaning and maintenance must be carried out only by qualified service personnel. Before cleaning, stop operation and switch off the power supply.

### 1. PRE-FILTER

Please clean the Pre-filter once about every two weeks. By doing so, the power rates are saved. In case the air filter is full of dust, the air flow will decrease and the cooling capacity will be reduced. Further, noise may occur. Be sure to clean the Pre-filter following the procedure below.

#### PROCEDURE

- 1 Open the front panel and remove the Pre-filter
  - Gently lift and remove the air purifying filters from the air purifying filter frame.

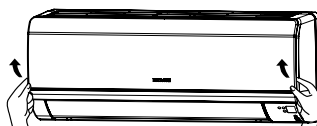

- 2 Vacuum dust from the Pre-filter and air purifying filter using vacuum cleaner. If there is too much dust, wipe the filter with wet cloth or sponge. Allow filters to dry in shade.

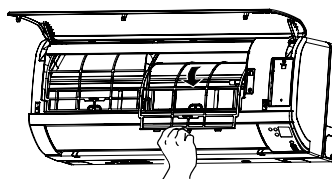

- 3
  - Re-insert the air purifying filter to the filter frame. Set the Pre-filter with "FRONT" mark facing front, and slot them into the original state.
  - After attaching the Pre-filters, push the front panel at three arrow portions as shown in figure and close it.

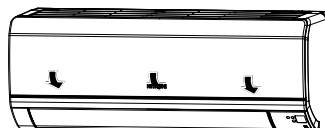

#### NOTE:

- Air purifying filter should be cleaned every month or sooner if noticeable loading occurs. When used overtime, it may lose its deodorizing function. For maximum performance, it is recommended to replace it every 1 year depending on application requirements.

### ⚠ CAUTION

- Do not operate the air conditioner without Pre-filter. Dust may enter the air conditioner and fault may occur.



## 2. CLEANING OF FRONT PANEL

- Remove the front panel and wash with clean water.  
Wash it with a soft sponge.  
After using neutral detergent, wash thoroughly with clean water.
- When front panel is not removed, wipe it with a soft dry cloth. Wipe the remote controller thoroughly with a soft dry cloth.
- Wipe the water thoroughly.  
If water remains at indicators or signal receiver of indoor unit, it causes trouble.

Method of removing the front panel.  
Be sure to hold the front panel with both hands to detach and attach it.

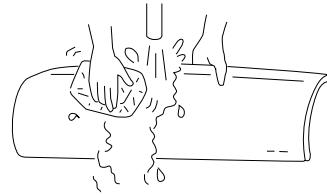

### Removing the Front Panel

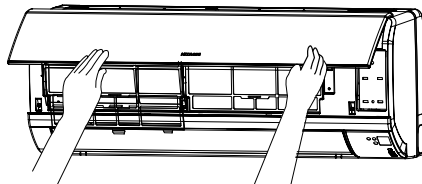

- When the front panel is fully opened with both hands, push the right arm to the inside to release it, and while closing the front panel slightly, pull it out forward.

### Attaching the Front Panel

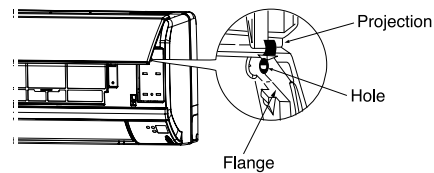

- Move the projections of the left and right arms into the Flanges in the unit and securely insert them into the holes.

### CAUTION

- Never use hot water (above 40°C), benzine, gasoline, acid, thinner or a brush, because they will damage the plastic surface and the coating.





**⚠ CAUTION**

- Please use earth line.  
Do not place the earth line near water or gas pipes, lightning-conductor, or the earth line of telephone. Improper installation of earth line may cause electric shock.
- A circuit breaker should be installed depending on the mounting site of the unit. Without a circuit breaker, the danger of electric shock exists.



**IMPORTANT**

The wires in this mains lead are coloured in accordance with the following code:

- Green-and-yellow : Earth
- Blue : Neutral
- Brown : Live

As the colours of the wires in the mains lead of this appliance may not correspond with the coloured markings identifying the terminals in your plug, proceed as follows:

The wire which is coloured green-and-yellow must be connected to the terminal in the plug which is marked with the letter E or by the earth symbol ⚡ or coloured green or green-and-yellow.

The wire which is coloured blue must be connected to the terminal which is marked with the letter N or coloured black.

The wire which is coloured brown must be connected to the terminal which is marked with the letter L or coloured red.

**NOTE**

If the supply cord is damaged, it must be replaced by the special cord obtainable at authorized service/parts centers.



**⚠ CAUTION**

Cleaning and maintenance must be carried out only by qualified service personnel. Before cleaning, stop operation and switch off the power supply.

**REGULAR INSPECTION**

PLEASE CHECK THE FOLLOWING POINTS BY QUALIFIED SERVICE PERSONNEL EITHER EVERY HALF YEARLY OR YEARLY. CONTACT YOUR SALES AGENT OR SERVICE SHOP.

<b>1</b>		Is the earth line disconnected or broken?
<b>2</b>		Is the mounting frame seriously affected by rust and is the outdoor unit tilted or unstable?
<b>3</b>		Is the plug of power line firmly plugged into the socket (if use)? (Please ensure no loose contact between them).



## AFTER SALE SERVICE AND WARRANTY

### WHEN ASKING FOR SERVICE, CHECK THE FOLLOWING POINTS

CONDITION	CHECK THE FOLLOWING POINTS
<p>If the remote controller is not transmitting a signal. (Remote controller display is dim or blank.)</p>	<ul style="list-style-type: none"> <li>Do the batteries need replacement?</li> <li>Is the polarity of the inserted batteries correct?</li> </ul>
<p>When it does not operate</p>	<ul style="list-style-type: none"> <li>Is the fuse all right?</li> <li>Is the voltage extremely high or low?</li> <li>Is the circuit breaker "ON"?</li> <li>Is the setting of operation mode different from other indoor units?</li> </ul>
<p>When it does not cool well When it does not heat well</p>	<ul style="list-style-type: none"> <li>Is the air filter blocked with dust?</li> <li>Does sunlight fall directly on the outdoor unit?</li> <li>Is the air flow of the outdoor unit obstructed?</li> <li>Are the doors or windows opened, or is there any source of heat in the room?</li> <li>Is the set temperature suitable?</li> <li>Are the air inlets or air outlets of indoor and outdoor units blocked?</li> <li>Is the fan speed "LOW" or "SILENT"?</li> </ul>

#### Notes



- In quiet or stop operation, the following phenomena may occasionally occur, but they are not abnormal for the operation.
  - Slight flowing noise of refrigerant in the refrigerating cycle.
  - Slight rubbing noise from the fan casing which is cooled and then gradually warmed as operation stops.
- The odor will possibly be emitted from the room air conditioner because the various odor, emitted by smoke, foodstuffs, cosmetics and so on, sticks to it. So the air filter and the evaporator regularly must be cleaned to reduce the odor.

- Please contact your sales agent immediately if the air conditioner still fails to operate normally after the above inspections. Inform your agent of the model of your unit, production number, date of installation. Please also inform him regarding the fault.
- Power supply shall be connected at the rated voltage, otherwise the unit will be broken or could not reach the specified capacity.

#### NOTE:

- If the supply cord is damaged, it must be replaced by the special cord obtainable at authorized service parts centers.



**Please note:**

On switching on the equipment, particularly when the room light is dimmed, a slight brightness fluctuation may occur. This is of no consequence.  
The conditions of the local Power Supply Companies are to be observed.

**Note**

- Avoid to use the room air conditioner for cooling operation when the outside temperature is below  $-10^{\circ}\text{C}$  ( $14^{\circ}\text{F}$ ).  
The recommended maximum and minimum operating temperatures of the hot and cold sides should be as below:

		Cooling		Heating	
		Minimum	Maximum	Minimum	Maximum
Indoor	Dry bulb $^{\circ}\text{C}$	21	32	20	27
	Wet bulb $^{\circ}\text{C}$	15	23	12	19
Outdoor	Dry bulb $^{\circ}\text{C}$	-10	46	-15	21
	Wet bulb $^{\circ}\text{C}$	-	26	-	15

**MEMO**

---

.....

.....

.....

.....

.....

.....

.....

.....

.....

.....

.....

.....

.....

.....

.....

.....

.....

.....

.....

.....

.....

.....

.....









<H961: (A) >

