

HITACHI

ENGLISH

SPLIT TYPE AIR CONDITIONER

INDOOR UNIT/OUTDOOR UNIT



MODEL

RAS-E25YHA/RAC-E25YHA
RAS-E35YHA/RAC-E35YHA

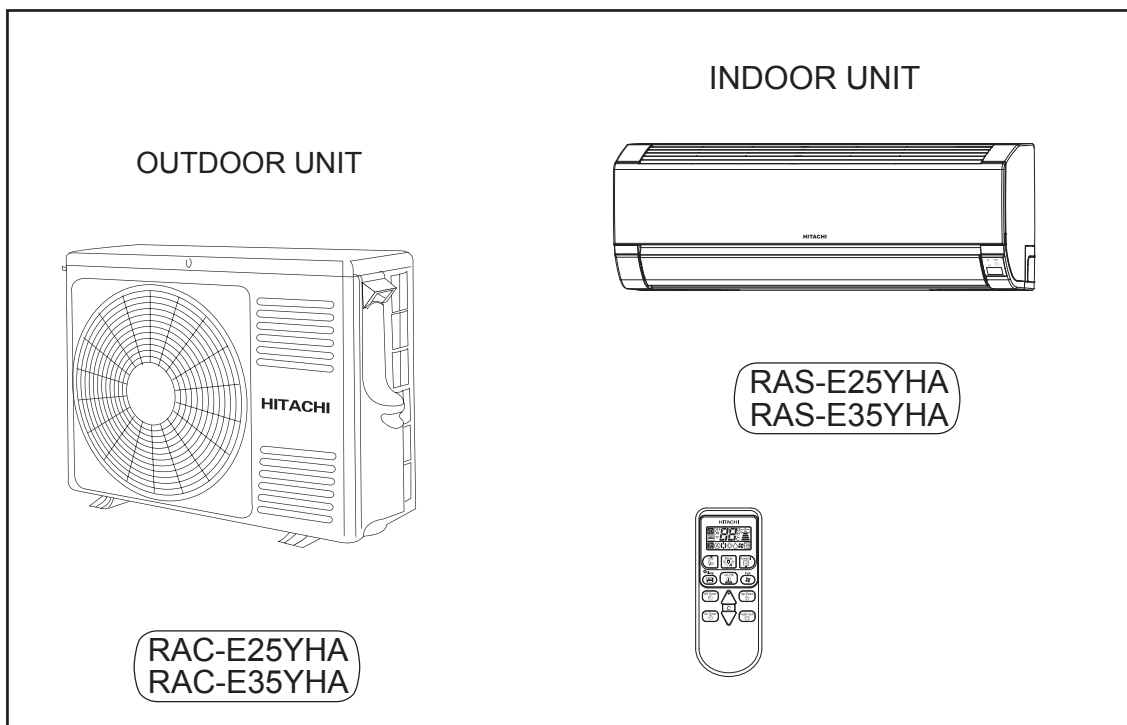

Instruction manual

Page 1~20

To obtain the best performance and ensure years of trouble free use, please read this instruction manual completely.

SAFETY PRECAUTION



This appliance is filled with R32.

- Please read the “Safety Precaution” carefully before operating the unit to ensure correct usage of the unit.
- Pay special attention to signs of “**▲ Warning**” and “**▲ Caution**”. The “Warning” section contains matters which, if not observed strictly, may cause death or serious injury. The “Caution” section contains matters which may result in serious consequences if not observed properly. Please observe all instructions strictly to ensure safety.
- The signs indicate the following meanings. (The following are examples of signs.)

	Make sure to connect earth line.		This sign in the figure indicates prohibition.
	Indicates the instructions that must be followed.		

- The appliance is not to be used by persons (including children) with reduced physical, sensory or mental capabilities, or lack of experience and knowledge, unless they have been given supervision or instruction.
- Children being supervised not to play with the appliance.
- Please keep this manual after reading.

PRECAUTIONS DURING INSTALLATION













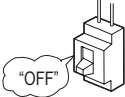







 WARNING	<ul style="list-style-type: none"> • Do not reconstruct the unit. Water leakage, fault, short circuit or fire may occur if you reconstruct the unit by yourself. 	 PROHIBITION
	<ul style="list-style-type: none"> • Please ask your sales agent or qualified technician for the installation of your unit. Water leakage, short circuit or fire may occur if you install the unit by yourself. 	
	<ul style="list-style-type: none"> • Please use earth line. Do not place the earth line near water or gas pipes, lightning-conductor, or the earth line of telephone. Improper installation of earth line may cause electric shock. 	 CONNECT EARTH LINE
	<ul style="list-style-type: none"> • Be sure to use the specified piping set for R32. Otherwise, this may result in broken copper pipes or faults. 	
	<ul style="list-style-type: none"> • If the supply cord is damaged, it must be replaced by a special cord or assembly available from the manufacturer or its service agent. 	
 CAUTION	<ul style="list-style-type: none"> • A circuit breaker should be installed depending on the mounting site of the unit. Without a circuit breaker, the danger of electric shock exists. 	
	<ul style="list-style-type: none"> • Do not install the unit near a location where there is flammable gas. The outdoor unit may catch fire if flammable gas leaks around it. Piping shall be suitable supported with a maximum spacing of 1m between the supports. 	 PROHIBITION
	<ul style="list-style-type: none"> • Please ensure smooth flow of water when installing the drain hose. If any failure is found in the drain path, water drops from the indoor and outdoor units, causing wet household effects. 	
	<ul style="list-style-type: none"> • Make sure that a single phase 220-240V power source is used. The use of other power sources may cause electrical components to overheat and lead to fire. 	 PROHIBITION

PRECAUTIONS DURING SHIFTING OR MAINTENANCE

 WARNING	<ul style="list-style-type: none"> • Should abnormal situation arise (like burning smell), please stop operating the unit and remove plug from the socket or turn off the circuit breaker. Contact your agent. Fault, short circuit or fire may occur if you continue to operate the unit under abnormal situation. 	 "OFF"
	<ul style="list-style-type: none"> • Please contact your agent for maintenance. Improper self maintenance may cause electric shock and fire. 	
	<ul style="list-style-type: none"> • Please contact your agent if you need to remove and reinstall the unit. Electric shock or fire may occur if you remove and reinstall the unit yourself improperly. 	
	<ul style="list-style-type: none"> • Avoid an extended period of direct air flow for your health. 	 PROHIBITION
	<ul style="list-style-type: none"> • Do not connect the power cable with an extension cable or do not plug too many leads of the other electric appliance into the socket where this cable is plugged. In addition, wire the cable with some allowances to prevent the cable from stretching. Not doing so will cause an electrical shock, heat generation or fire. 	 PROHIBITION
	<ul style="list-style-type: none"> • Do not bundle the power cable, pull it, put something on it, heat it, process it, or put it between things. Breakage of the power cable may result. Use of a damaged cable may cause an electrical shock or a fire. 	 PROHIBITION
	 PROHIBITION <ul style="list-style-type: none"> • Do not put objects like thin rods into the panel of blower and suction side because the high-speed fan inside may cause danger. 	



PRECAUTIONS DURING OPERATION

WARNING	<ul style="list-style-type: none"> Do not use any conductor as fuse wire, this could cause fatal accident. 
	  <ul style="list-style-type: none"> During thunder storm, disconnect the plug top or turn off the circuit breaker.
	<ul style="list-style-type: none"> Spray cans and other combustibles should not be located within a meter of the air outlets of both indoor and outdoor units. As a spray can's internal pressure can be increased by hot air, a rupture may result. 
CAUTION	<ul style="list-style-type: none"> The product shall be operated under the manufacturer specification and not for any other intended use. 
	 <ul style="list-style-type: none"> Do not attempt to operate the unit with wet hands, this could cause fatal accident.
	<ul style="list-style-type: none"> When operating the unit with burning equipments, regularly ventilate the room to avoid oxygen insufficiency.  
	 <ul style="list-style-type: none"> Do not direct the cool air coming out from the air-conditioner panel to face household heating apparatus as this may affect the working of apparatus such as the electric kettle, oven etc.
	<ul style="list-style-type: none"> Please ensure that outdoor mounting frame is always stable, firm and without defect. If not, the outdoor unit may collapse and cause danger. 
	 <ul style="list-style-type: none"> Do not wash the unit with water or place a water container such as a vase on the indoor unit. Electrical leakage could be present and cause electric shock.
	<ul style="list-style-type: none"> Do not place plants or animals directly under the air flow as it is bad for the plants or animals. 
	 <ul style="list-style-type: none"> Do not climb on the outdoor unit or put objects on it.
	<ul style="list-style-type: none"> When operating the unit with the door and windows opened, (the room humidity is always above 80%) and with the air deflector facing down or moving automatically for a long period of time, water will condense on the air deflector and drips down occasionally. This will wet your furniture. Therefore, do not operate under such condition for a long time. 
	 <ul style="list-style-type: none"> If the amount of heat in the room is above the cooling or heating capability of the unit (for example: more people entering the room, using heating equipments and etc.), the preset room temperature cannot be achieved.
	<ul style="list-style-type: none"> This appliance especially indoor unit cleaning must be performed by authorized personnel only. Consult your sales agent. Using a commercially available detergent or similar can damage the plastic parts or clog the drain pipe, causing water to drip with potential electric shock hazard. 
	  <ul style="list-style-type: none"> Do not touch the air outlet, bottom surface and aluminum fin of the outdoor unit. You may get hurt.
	<ul style="list-style-type: none"> Do not touch the refrigerant pipe and connecting valve. Burns may result.  
	<ul style="list-style-type: none"> This appliance is not intended for use by young children or infirm persons unless they have been adequately supervised by a responsible person to ensure that they can use this appliance safely. Young children should be supervised to ensure that they do not play with the appliance. If the supply cord is damaged, it must be replaced by the manufacturer, its service agent or similarly qualified persons in order to avoid a hazard.

NAMES AND FUNCTIONS OF EACH PART

INDOOR UNIT

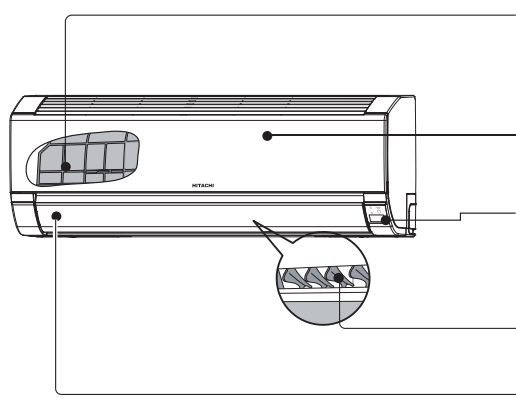

- Air filter
To prevent dust from coming into the indoor unit.
(Refer page 16)
- Front panel
(Refer page 17)
- Indoor unit indicators
Light indicator showing the operating condition.
(Refer page 5)
- Vertical deflector
(Refer page 15)
- Horizontal deflector
(Air Outlet)
(Refer page 15)



- Remote controller
Send out operation signal to the indoor unit. So as to operate the whole unit.
(Refer page 6)

OUTDOOR UNIT

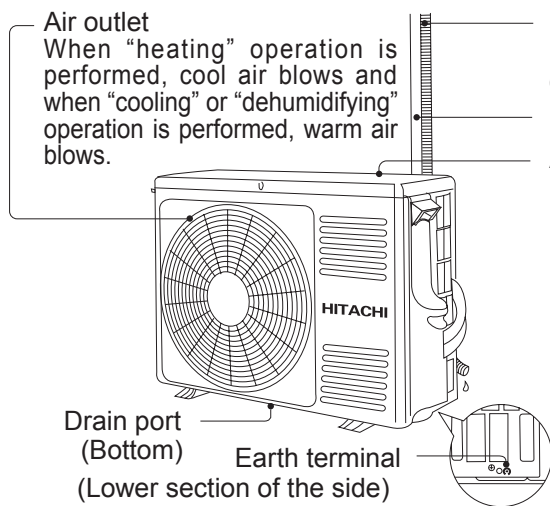

- Air outlet
When "heating" operation is performed, cool air blows and when "cooling" or "dehumidifying" operation is performed, warm air blows.
- Drain hose
Drains the dehumidified water from the indoor unit to the outdoor during "cooling" or "dehumidifying" operation.
- Piping and Wiring
- Air inlets (Rear and left sides)

About the outdoor unit:

- When "Stop" is selected during operation of the indoor unit, the fan of the outdoor unit continues turning for 10 to 60 seconds to cool the electric parts down.
- In heating operation, condensate or water due to defrosting will flow. Do not cover the drain port of the outdoor unit because such water may freeze in the chilly area.
- When the outdoor unit is hung on the ceiling, install the bush and drain pipe on the drain port and drain water.

MODEL NAME AND DIMENSIONS

MODEL	WIDTH (mm)	HEIGHT (mm)	DEPTH (mm)
RAS-E25YHA/RAS-E35YHA	780	280	218
RAC-E25YHA/RAC-E35YHA	750	548	288

NAMES AND FUNCTIONS OF EACH PART

INDOOR UNIT INDICATIONS

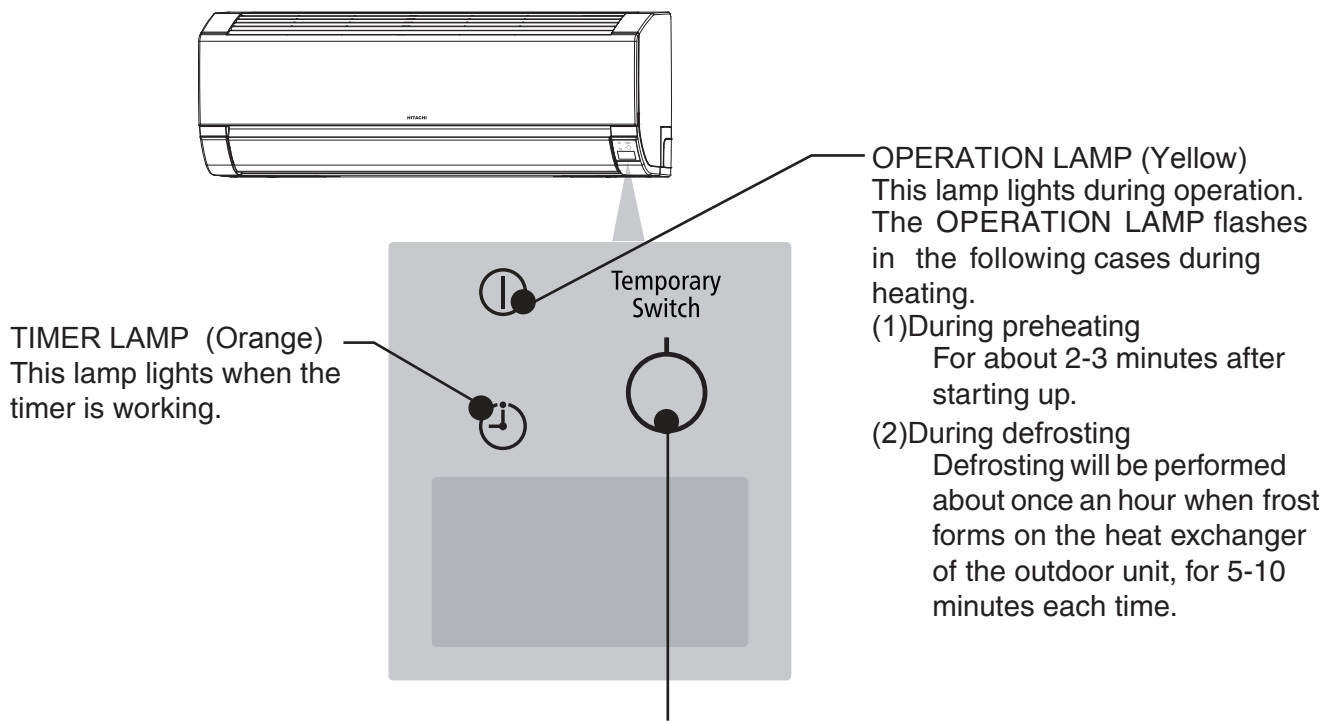

TIMER LAMP (Orange)
This lamp lights when the timer is working.

OPERATION LAMP (Yellow)
This lamp lights during operation. The OPERATION LAMP flashes in the following cases during heating.

- (1) During preheating
For about 2-3 minutes after starting up.
- (2) During defrosting
Defrosting will be performed about once an hour when frost forms on the heat exchanger of the outdoor unit, for 5-10 minutes each time.

TEMPORARY SWITCH

Use this switch to start and stop when the remote controller does not work.

- By pressing the temporary switch, the operation is done in automatic mode.
- When the operation is done using the temporary switch after the power source is turned off and turn on again, the operation is done in automatic mode.

⚠ CAUTION
Turn off the circuit breaker or pull out the power plug if the unit is not be operated for a long period.

☆ If the power stays on and the unit is not operated, power is slightly consumed in the control circuit. The power is saved by turning off the power switch (or the circuit breaker when the power is supplied from the outdoor unit).

■ Attaching the Wasabi Air Cleaning Mesh (Accessories) to the filter frame.

- Attach the Wasabi Air Cleaning Mesh to the C-case by gently compress its both sides and release after insertion into filter frame.
- The cooling capacity is slightly weakened and the cooling speed becomes slower when the Wasabi Air Cleaning Mesh are used.
- Wasabi Air Cleaning Mesh are washable and reusable up to 20 times by using vacuum cleaner or water rinse under running tap water. When you want to renew it, please ask your sales agent. Optional air cleansing and deodorizing filters.

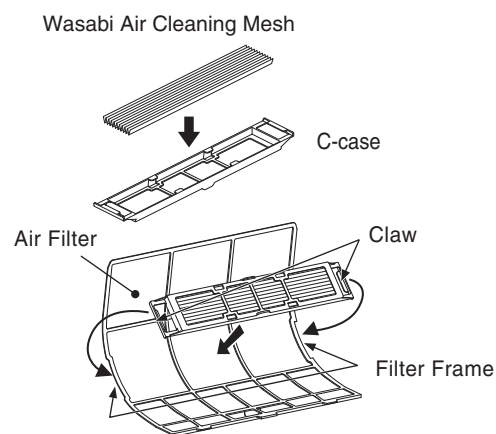

NAMES AND FUNCTIONS OF EACH PART

REMOTE CONTROLLER

- This controls the operation of the indoor unit.
The range of control is about 7 meters. If indoor lighting is controlled electronically, the range of control may be shorter, in some cases, the control signal may not be received.
This unit can be fixed on a wall using the fixture provided. Before fixing it, make sure the indoor unit can be controlled from the remote controller.
- Handle the remote controller with care.
Dropping it or getting it wet may compromise its signal transmission capability.
- After new batteries are inserted into the remote controller, the unit will initially require approximately 10 seconds to respond to commands and operate.

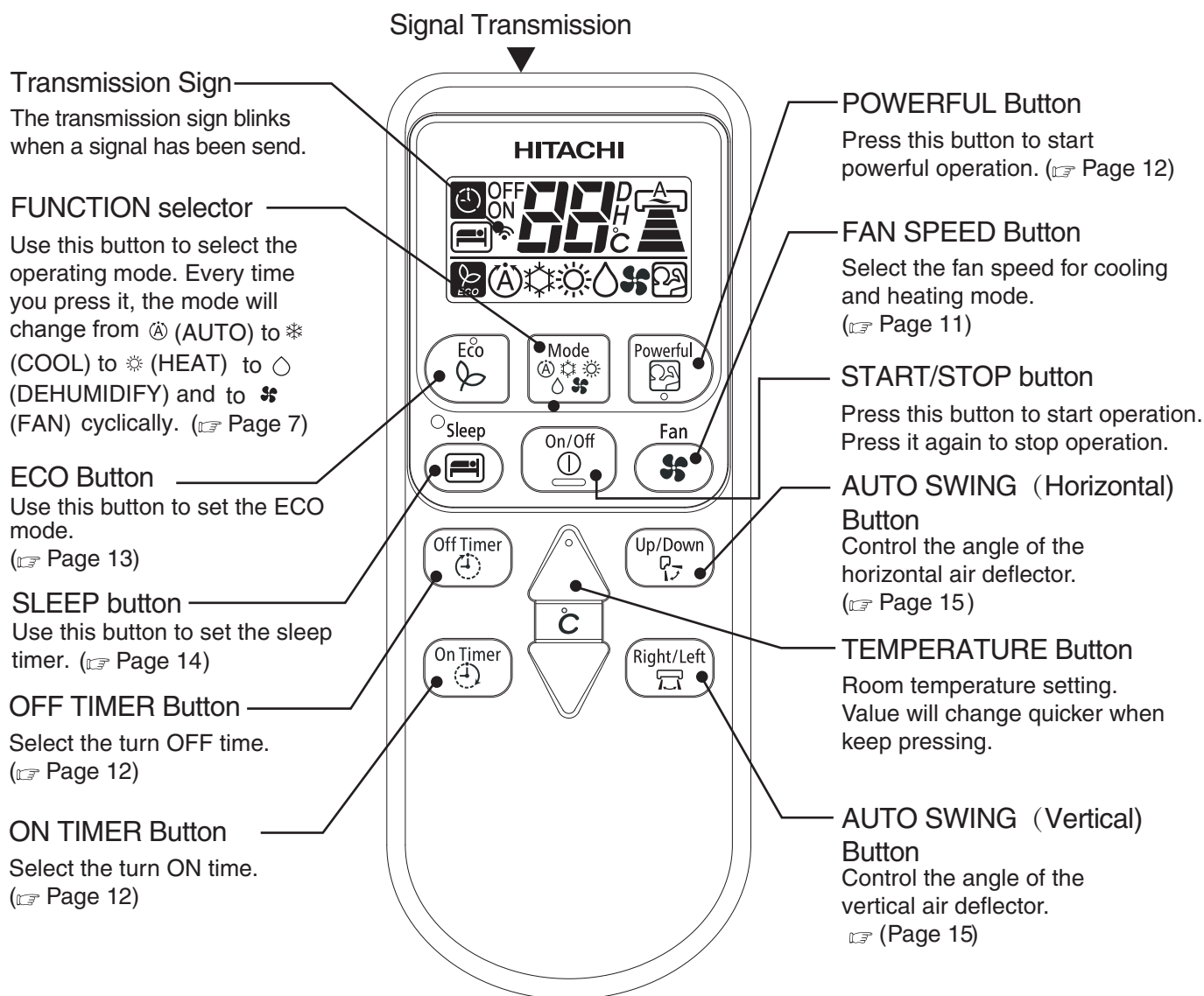

Precautions for Use

- Do not put the remote controller in the following places.
 - In direct sunlight
 - In the vicinity of a heater.
- Handle the remote controller carefully. Do not drop it on the floor, and protect it from water.
- Once the outdoor unit stops, it will not restart for about 3 minutes (unless you turn the power switch off and on or unplug the power cord and plug it in again).
This is to protect the device and does not indicate a failure.
- If you press the FUNCTION selector button during operation, the device may stop for about 3 minutes for protection.

VARIOUS FUNCTIONS

■ Auto Restart Control

- If there is a power failure, operation will be automatically restarted when the power is resumed with previous operation mode and airflow direction.
(As the operation is not stopped by remote controller.)
 - If you intend not to continue the operation when the power is resumed, switch off the power supply. When you switch on the circuit breaker, the operation will be automatically restarted with previous operation mode and airflow direction.
- Note: 1. If you do not require Auto Restart Control, please consult your sales agent.
2. Auto Restart Control is not available when Timer or Sleep Timer mode is set.

AUTOMATIC OPERATION

The device will automatically determine the mode of operation, HEAT or COOL depending on the current room temperature. The selected mode of operation will change when the room temperature varies. However, the mode of operation will not change when indoor unit is connected to multi type outdoor unit.

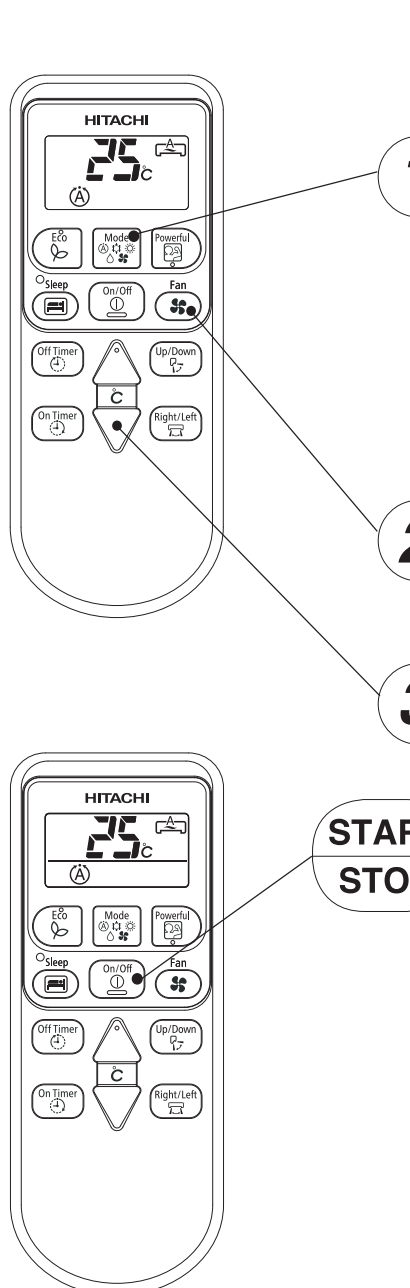

1 Press the MODE selector button so that the display indicates the **(A)** (AUTO) mode of operation.

- When AUTO has been selected, the device will automatically determine the mode of operation, HEAT or COOL depending on the current room temperature. However the mode of operation will not change when indoor unit is connected to multi type outdoor unit.
- If the mode automatically selected by the unit is not satisfactory, manually change the mode setting (HEAT, DEHUMIDIFY, COOL or FAN).

2 Set the desired FAN SPEED with the **(FAN SPEED)** button (the display indicates the setting).

(AUTO) → (HIGH) → (MED) → (LOW) → (SILENT) → (AUTO)

3 Set the desired room temperature with the TEMPERATURE buttons (the display indicates the setting).
The temperature setting and the actual room temperature may vary depending on conditions.

START STOP Press the **(START/STOP)** button.
Operation starts with a beep.
Press the button again to stop operation.

■ As the settings are stored in the memory of the remote controller, you only have to press the **(START/STOP)** button next time.

Press the **(FAN SPEED)** button to select AUTO, HIGH, MED, LOW or SILENT.

HEATING OPERATION

- Use the device for heating when the outdoor temperature is under 27°C. When it is too warm (over 27°C), the heating function may not work in order to protect the device.
- In order to keep reliability of the device, please use this device above -15°C of the outdoor temperature.

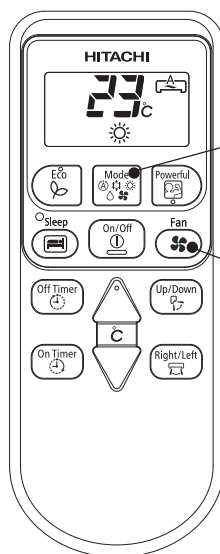

1 Press the FUNCTION selector so that the display indicates ☀ (HEAT).

Set the desired FAN SPEED with the 🌀 (FAN SPEED) button (the display indicates the setting).

🌀 (AUTO) : The fan speed changes automatically according to the temperature of the air which blows out.

🌀 (HI) : Economical as the room will become warm quickly. But you may feel a chill at the beginning.

🌀 (MED) : Quiet.

🌀 (LOW) : More quiet.

🌀 (SILENT) : Silent.

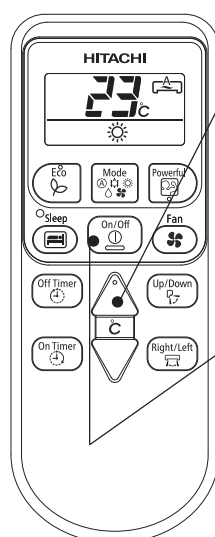

3 Set the desired room temperature with the TEMPERATURE buttons (the display indicates the setting).

The temperature setting and the actual room temperature may vary somewhat depending on conditions.

START STOP Press the ⏻ (START/STOP) button. Heating operation starts with a beep. Press the button again to stop operation.

- As the settings are stored in memory in the remote controller, you only have to press the ⏻ (START/STOP) button next time.

■ Defrosting

Defrosting will be performed about once an hour when frost forms on the heat exchange of the outdoor unit, for 5~10 minutes each time.

During defrosting operation, the operation lamp blinks in cycle of 3 seconds on and 0.5 second off.

The maximum time for defrosting is 20 minutes.

(If the piping length used is longer than usual, frost will likely to form.)

DEHUMIDIFYING OPERATION

Use the device for dehumidifying when the room temperature is over 16°C.
When it is under 15°C, the dehumidifying function will not work.

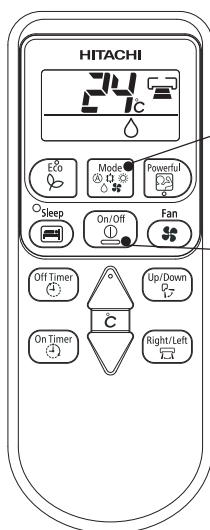

1

Press the FUNCTION selector so that the display indicates
◊ (DEHUMIDIFY).
Press the  (FAN SPEED) button to select LOW and SILENT.

START
STOP

Press the  (START/STOP) button.

- When you want to change the operation mode, please use the FUNCTION selector.
- Set the desired temperature is available.
- You also can use the FUNCTION selector to select this operation.

■ Dehumidifying Function

- Dehumidifying takes place with a target temperature which is slightly lower than the room temperature setting. (However, target temperature is 16°C for a temperature setting of 16°C.) If the room temperature becomes lower than the target value, operation stops. If the room temperature becomes higher than the target value, operation restarts.
- The preset room temperature may not be reached depending on the number of people present in the room conditions.

COOLING OPERATION

Use the device for cooling when the outdoor temperature is -10 to 46°C.
If humidity is very high (over 80%) indoors, some dew may form on the air outlet grille of the indoor unit.

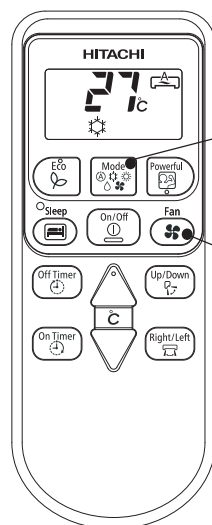

1

Press the FUNCTION selector so that the display indicates * (COOL).

2

Set the desired FAN SPEED with the * (FAN SPEED) button (the display indicates the setting).

(AUTO) : The FAN SPEED is HI at first and varies to MED automatically when the preset temperature has been reached.

(HI) : Economical as the room will become cool quickly.

(MED) : Quiet.

(LOW) : More quiet.

(SILENT) : Silent.

3

Set the desired room temperature with the TEMPERATURE buttons (the display indicates the setting).

The temperature setting and the actual room temperature may vary somewhat depending on conditions.

START
STOP

Press the (START/STOP) button. Cooling operation starts with a beep. Press the button again to stop operation. The cooling function does not start if the temperature setting is higher than the current room temperature (even though the (OPERATION) lamp lights).

The cooling function will start as soon as you set the temperature below the current room temperature.

■ As the settings are stored in memory in the remote controller, you only have to press the (START/STOP) button next time.

FAN OPERATION

You can use the device simply as an air circulator. Use this function to dry the interior of the indoor unit at the end of summer.

1 Press the FUNCTION selector so that the display indicates (FAN).

2 Press the (FAN SPEED) button.

(HI) : The strongest air blow.
 (MED) : Quiet.
 (LOW) : More quiet.
 (SILENT) : Silent.

START/STOP Press the (START/STOP) button. Fan operation starts with a beep.
 Press the button again to stop operation.

FAN SPEED (AUTO) ... When the AUTO fan speed mode is set in the cooling/heating operation:

For the heating operation	<ul style="list-style-type: none"> The fan speed will automatically change according to the temperature of discharged air. As room temperature reaches the preset temperature, a very light breeze will blow.
For the cooling operation	<ul style="list-style-type: none"> Operation starts in the "HI" mode to reach the preset temperature. As room temperature approaches the preset temperature, fan speed automatically switches to "LOW".

TIMER RESERVATION

- ON Timer and OFF Timer are available.

Timer Reservation

- 1**  OFF TIME setting

 - Select the OFF TIME by pressing the  (OFF) Button.
 - Setting time will change according to the below sequence when you press the button.

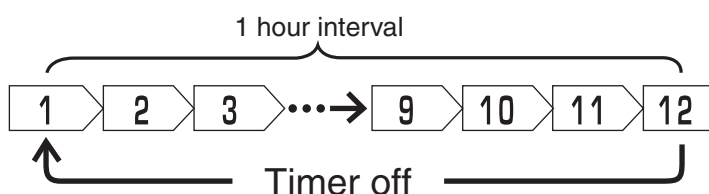

- 2**  ON TIME setting

 - Select the ON TIME by pressing the  (ON) Button.
 - Setting time will change according to the below sequence when you press the button.

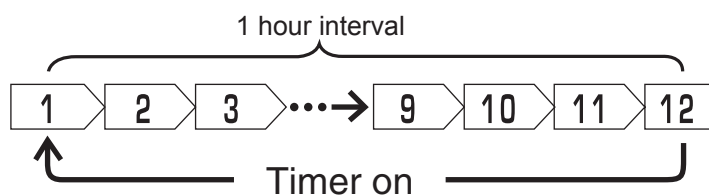

- Operation stop at setting time

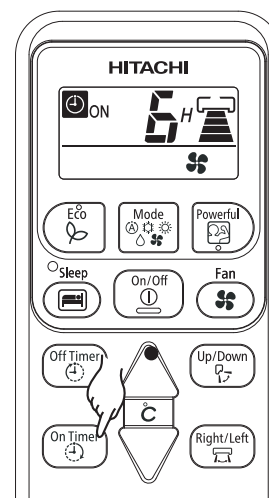
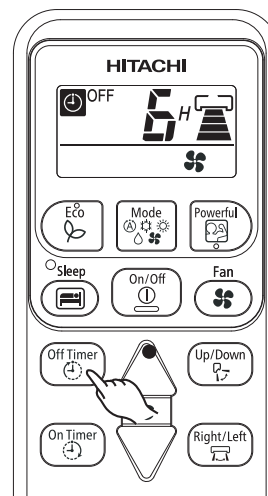

POWERFUL OPERATION

- By pressing  (POWERFUL) button during HEATING, DEHUMIDIFYING, COOLING, FAN, AUTOMATIC operation, the air conditioner performs at maximum power.
- During POWERFUL operation, cooler or warmer air will be blown out from indoor unit for COOLING or HEATING operation respectively.

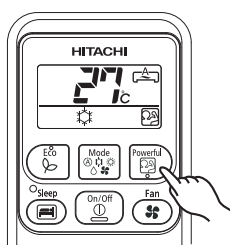



START

Press the  (POWERFUL) button during operation.

- "  " is displayed on the LCD.
- POWERFUL operation ends in 20 minutes. Then the system automatically operates with the previous settings used before POWERFUL operation.

CANCEL

- Press the  (START/ STOP) button. or
- Press the  (POWERFUL) button again.
- "  " disappears from the LCD.

NOTE

- When ECO mode is selected, POWERFUL operation is cancelled.
- During POWERFUL operation, capacity of the air conditioner will not increase
 - if the air conditioner is already running at maximum capacity.
 - just before defrost operation (when the air conditioner is running in HEATING operation).
- After auto restart, POWERFUL operation is cancelled and previous operation shall start.

ECO OPERATION

- Energy saving operation by changing set temperature and by limiting the maximum power consumption value.

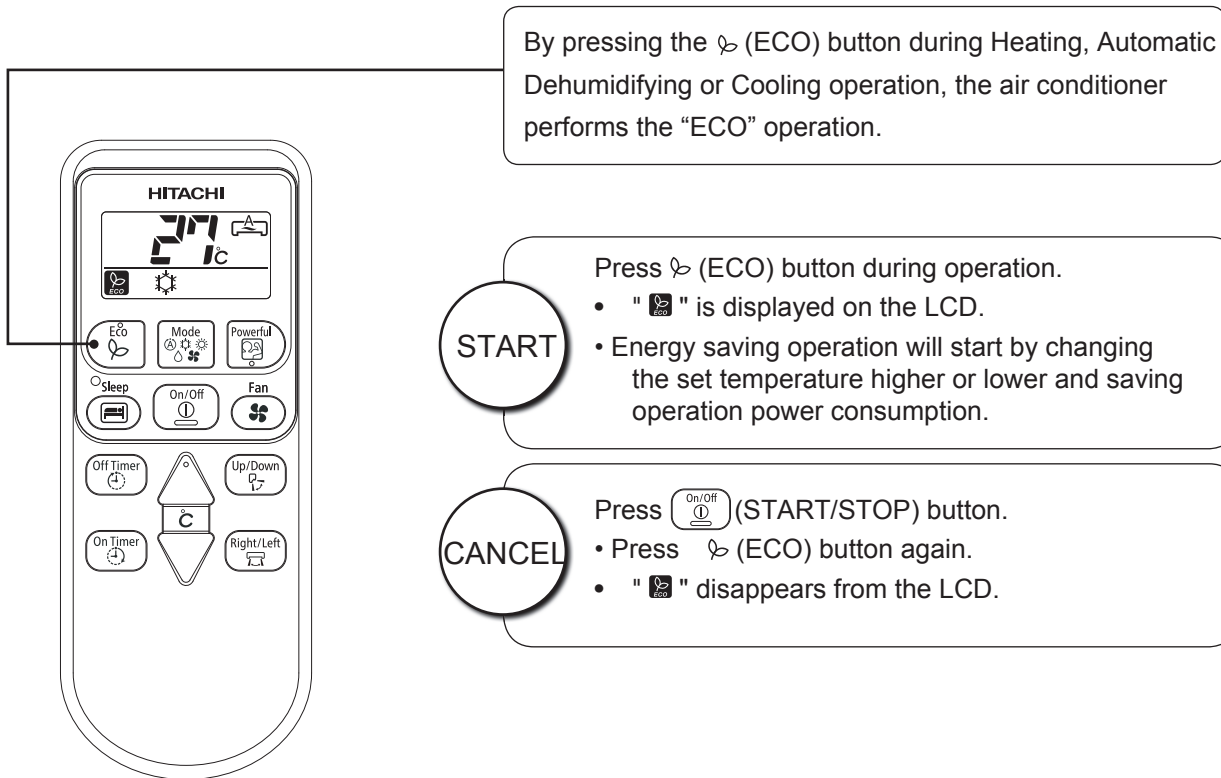

NOTE

- In case the power consumption is already low, ECO operation will not reduce the power consumption.
- By pressing (POWERFUL) button, ECO operation is cancelled.
- After auto restart, ECO operation is cancelled and previous operation mode shall start.

HOW TO SET THE SLEEP TIMER

By pressing  (SLEEP) button during AUTO, HEATING, DEHUMIDIFYING, COOLING or FAN operation, the unit shifts the room temperature and reduces the fan speed.

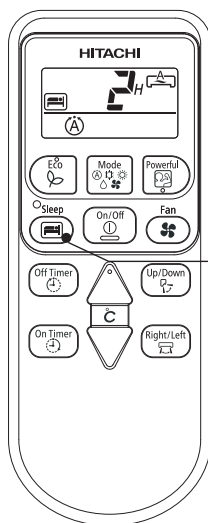

● SLEEP



Mode	Indication
Sleep Timer	

Sleep Timer: The device will continue working for the desired number of hours and then turn off.
 Point the signal window of the remote controller toward the indoor unit, and press the SLEEP button.
 The timer information will be displayed on the remote controller. The TIMER lamp lights with a beep from the indoor unit.

To cancel SLEEP TIMER operation.

Press  (START/STOP) button.

- Room air conditioner will switch off.

Press  (SLEEP) button again until off time, “” and number of hour disappear from the remote controller display.

- A beep sound emitted from indoor unit and the (TIMER) lamp on the indoor unit turns off.
- SLEEP TIMER operation is cancelled.

NOTE

If you set the sleep timer when the off-time or on-timer has been set earlier, the sleep timer becomes effective instead of the off - or on/off-timer set earlier.

ADJUSTING THE AIR DEFLECTORS

- 1** Adjustment of the conditioned air in the upward and downward directions.

The horizontal air deflector is automatically set to the proper angle suitable for each operation. The deflector can be swung up and down continuously and also set to the desired angle using the “Up/Down (AUTO SWING(HORIZONTAL))” button.

- If the “Up/Down (AUTO SWING(HORIZONTAL))” button is pressed once, the horizontal air deflector swings up and down. If the button is pressed again, the deflector stops in its current position. Several seconds (about 6 seconds) may be required before the deflector starts to move.
- Use the horizontal air deflector within the adjusting range shown in the right.
- When the operation is stopped, the horizontal air deflector moves and stops at the position where the air outlet closes.

CAUTION

- In “Cooling” operation, do not keep the horizontal air deflector swinging for a long time. Some dew may form on the horizontal air deflector and dew may drop.

- 2** Adjustment of the conditioned air to the left and right.

- If the “Right/Left (AUTO SWING(VERTICAL))” button is pressed once, the deflectors will start to swing right and left. If the button is pressed again, the deflector will stop in the current position. Several seconds (about 6 seconds) may be required before the deflector starts to move.

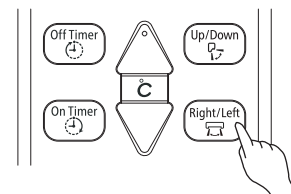
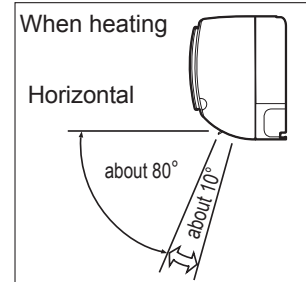
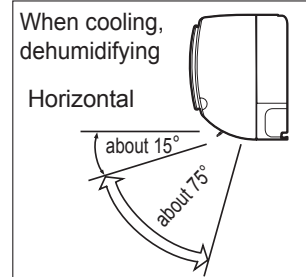
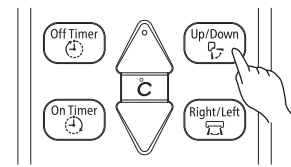

HOW TO EXCHANGE THE BATTERIES IN THE REMOTE CONTROLLER

- 1** Remove the cover as shown in the figure and take out the old batteries.



- 2** Install the new batteries. The direction of the batteries should match the marks in the case.

CAUTION

1. Do not use new and old batteries, or different kinds of batteries together.
2. Take out the batteries when you do not use the remote controller for 2 or 3 months.

Push and pull to the direction of arrow

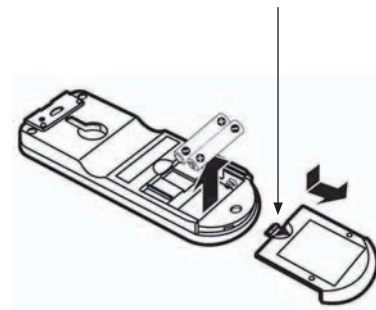

MAINTENANCE

⚠ CAUTION

Cleaning and maintenance must be carried out only by qualified service personal. Before cleaning, stop operation and switch off the power supply.

1. AIR FILTER

Please clean the filter once about every two weeks. By doing so, the power rates are saved. In case the air filter is full of dust, the air flow will decrease and the cooling capacity will be reduced. Further, noise may occur. Be sure to clean the filter following the procedure below.

PROCEDURE

- ① Open the front panel carefully and remove the filter.

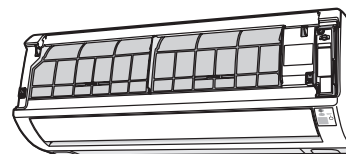

- ② Vacuum dust from the air filter using vacuum cleaner. If there is too much dust, wash the filter with a detergent and rinse it thoroughly. After that, dry it in the shade.

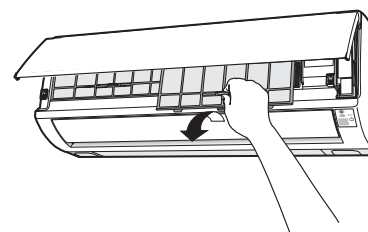

- ③
- Set the filter with "FRONT" mark facing front, and slot them into the original state.
 - After attaching the filters, push the front panel at three arrow portions as shown in figure and close it.

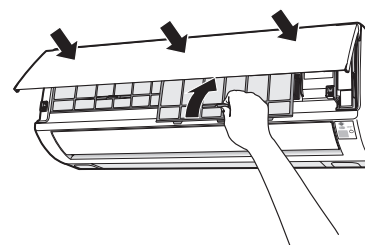

⚠ CAUTION

- Do not wash with hot water at more than 40°C. The filter may shrink.
- When washing it, shake off moisture completely and dry it in the shade; do not expose it directly to the sun. The filter may shrink.
- Don't operate the unit without filter. Fault may occur if you continue.

2. CLEANING OF FRONT PANEL

- Remove the front panel and wash with clean water. Wash it with a soft sponge. After using neutral detergent, wash thoroughly with clean water.
- When front panel is not removed, wipe it with a soft dry cloth. Wipe the remote controller thoroughly with a soft dry cloth.
- Wipe the water thoroughly. If water remains at indicators or signal receiver of indoor unit, it causes trouble.



Method of removing the front panel.
Be sure to hold the front panel with both hands to detach and attach it.

Removing the Front Panel

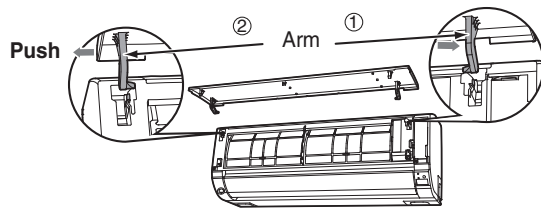

1. Push the end of the right-side arm outward to release the tab.
2. Move the left-side arm outward to release the left tab, and then pull the panel towards you.

Attaching the Front Panel

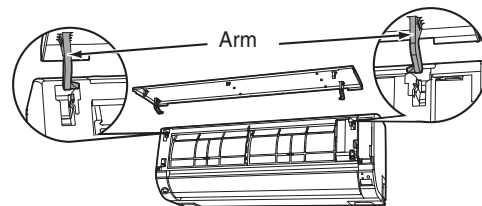

1. Insert the shaft of the left arm along the step on the unit into the hole.
2. Securely insert the shaft of the right arm along the step on the unit into the hole.
3. Make sure that the front panel is securely attached, and then close the front panel.

CAUTION

- Do not splash or direct water to the body of the unit when cleaning it as this may cause short circuit.
- Never use hot water (above 40°C), benzine, gasoline, acid, thinner or a brush, because they will damage the plastic surface and the coating.



3. MAINTENANCE AT BEGINNING OF LONG OFF PERIOD

- Run the unit by setting the operation mode to  (FAN) and the fan speed to HI for about half a day on a fine day, and dry the whole of the unit.
- Switch off the power plug or turn off the circuit breaker.

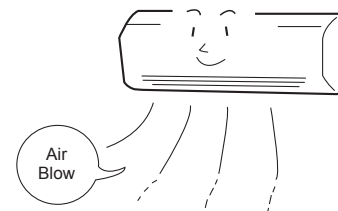

INFORMATION

CAPABILITIES

Heating Capability

- This room air conditioner utilizes a heat pump system that absorbs exterior heat and brings it into a room to be heated. As the ambient temperature gets lower, heating capability will also lower. In such a situation, the inverter works to increase compressor rpm to keep the unit's heating capability from decreasing. If the unit's heating performance is still unsatisfactory, other heating appliances should be used to augment this unit's performance.
- The air conditioner is designed to heat an entire room so that it may take some time before you feel warm. Timer operation is recommended for effective preheating ahead of the desired time.

CAUTION

Do not use a stove or any other high temperature devices in proximity to the indoor unit.



Cooling and Dehumidifying Capabilities







- If the heat present in a room exceeds the unit's cooling capacity (for example, if there are many people in the room or other heating appliances are used), the preset room temperature may not be reached.

REFRIGERANT INFORMATION

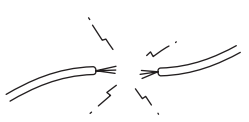
- **For the refrigerant charge information, please refer to the outdoor unit installation manual or specification label.**

REGULAR INSPECTION

PLEASE CHECK THE FOLLOWING POINTS EVERY EITHER HALF YEARLY OR YEARLY. CONTACT YOUR SALES AGENT SHOULD YOU NEED ANY HELP.

1		 WARNING	Check to see if the unit's earth line has been connected correctly. If the earth line is disconnected or faulty, unit failure or electric shock hazard may result.
2		 WARNING	Check to see if the mounting frame has rusted excessively or if the outdoor unit has tilted or become unstable. It could collapse or fall, causing injury.
3		 WARNING	Check to see if the power plug is securely inserted into the wall socket. If the power plug is not inserted into the wall socket securely or becomes hot, an electric shock or fire may result. If dust or dirt is found on the power plug, clean the plug and insert it into the wall socket.

AFTER SALES SERVICE AND WARRANTY

WHEN ASKING FOR SERVICE, CHECK THE FOLLOWING POINTS.

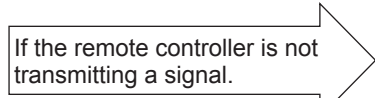
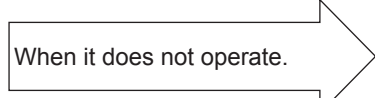
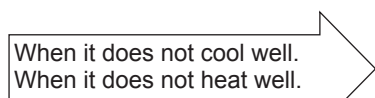
CONDITION	CHECK THE FOLLOWING POINTS
 If the remote controller is not transmitting a signal. (Remote controller display is dim or blank.)	<ul style="list-style-type: none"> • Do the batteries need replacement? • Is the polarity of the inserted batteries correct?
 When it does not operate.	<ul style="list-style-type: none"> • Is the fuse all right? • Is the voltage extremely high or low? • Is the circuit breaker "ON"? • Is the power plug inserted? • Do you have any power cut?
 When it does not cool well. When it does not heat well.	<ul style="list-style-type: none"> • Is the air filter blocked with dust? • Is the set temperature suitable? • Have horizontal air deflectors been adjusted to their correct positions according to the operation mode selected? • Are the air inlets or air outlets of indoor and outdoor units blocked? • Is the fan speed "LOW" or "SILENT"?

■ The following phenomena do not indicate unit failure.

During heating, the operation indicator blinks and air blow stops	<Operation start> The unit is preparing to blow warm air. Please wait. <In operation> The outdoor unit is defrosting. Please wait.
Hissing or fizzy sounds	Refrigerant flow noise in the pipe or valve sound generated when flow rate is adjusted.
Squeaking noise	Noise generated when the unit expands or contracts due to temperature changes.
Rustling noise	Noise generated with the indoor unit fan's rpm changing such as operation start times.
Clicking noise	Noise of the motorized valve when the unit is switched on.



Perking noise	Noise of the ventilation fan sucking in air present in the drain hose and blowing out dehumidifying water that had accumulated in the condensed water collector. For details, consult your sales agent.
Changing operation noise	Operation noise changes due to power variations according to room temperature changes.
Mist emission	Mist is generated as the air within the room is suddenly cooled by conditioned air.
Steam emitted from the outdoor unit	Water generated during defrosting operation evaporates and steam is emitted.
Odors	Caused as the smells and particles of smoke, food, cosmetics, etc. present in room air become attached the unit and blown off into the room again.
The outdoor unit continues to operate even if operation is stopped.	Defrosting is underway (as the heating operation is stopped, the microcomputer checks frost accumulated in the outdoor unit and instructs the unit to perform automatic defrosting if necessary).
The OPERATION lamp is blinking.	Shows preheating or defrosting operation is underway. As the protective circuit or preheat sensor operates when unit operation is stopped during preheating and then restarted, or when operation mode is switched from cooling to heating, the lamp continues to blink.
Does not reach the temperature setting	Actual room temperature may deviate slightly from the remote controller's temperature setting depending on the number of people in the room, indoor or outdoor conditions.

- If the unit still fails to operate normally after performing the above inspections, turn the circuit breaker off, or pull the power plug out, and contact your sales agent immediately.

Contact your sales agent immediately if the following phenomena should occur:

- The circuit breaker switches off or the fuse blows frequently.
- The switch operation is not stable.
- Foreign matter or water accidentally enters the unit interior.
- The power cord gets excessively hot or its insulation is torn or stripped.
- TIMER lamp on the indoor unit display blinks.



(As the nature of the failure can be identified by the blinking cycle, check the blinking cycle before turning off the circuit breaker.)



Notes

- In quiet operation or stopping the running, the following phenomena may occasionally occur, but they are not abnormal for the operation.
 - (1) Slight flowing noise of refrigerant in the refrigerating cycle.
 - (2) Slight rubbing noise from the fan casing which is cooled and then gradually warmed as operation stops.
- The odor will possibly be emitted from the room air conditioner because the various odor, emitted by smoke, foodstuffs, cosmetics and so on, sticks to it. So please clean the air filter and the evaporator regularly to reduce the odor.

- Please contact your sales agent immediately if the air conditioner still fails to operate normally after the above inspections. Inform your agent of the model of your unit, production number, date of installation. Please also inform him regarding the fault.

Please note:

On switching on the equipment, particularly when the room light is dimmed, a slight brightness fluctuation may occur. This is of no consequence.

The conditions of the local Power Supply Companies are to be observed.



MEMO

Series of horizontal lines for writing.



MEMO

Lined area for writing.

