

# HIKOKI

---

NT 1865DBAL • NT 1865DBSL • NT 1850DBSL

---

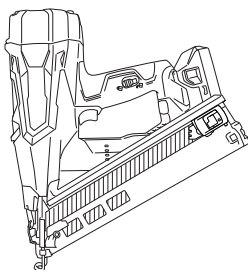

NT 1865DBAL

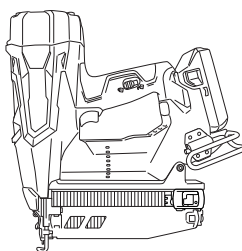

NT 1865DBSL

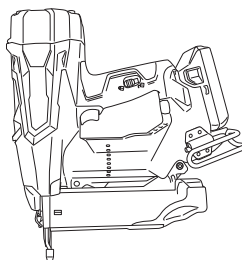

NT 1850DBSL



Handling instructions

## GENERAL POWER TOOL SAFETY WARNINGS

### WARNING

Read all safety warnings and all instructions.

Failure to follow the warnings and instructions may result in electric shock, fire and/or serious injury.

Save all warnings and instructions for future reference.

The term "power tool" in the warnings refers to your mains-operated (corded) power tool or battery-operated (cordless) power tool.

#### 1) Work area safety

- a) **Keep work area clean and well lit.**  
*Cluttered or dark areas invite accidents.*
- b) **Do not operate power tools in explosive atmospheres, such as in the presence of flammable liquids, gases or dust.**  
*Power tools create sparks which may ignite the dust or fumes.*
- c) **Keep children and bystanders away while operating a power tool.**  
*Distractions can cause you to lose control.*

#### 2) Electrical safety

- a) **Power tool plugs must match the outlet. Never modify the plug in any way. Do not use any adapter plugs with earthed (grounded) power tools.**  
*Unmodified plugs and matching outlets will reduce risk of electric shock.*
- b) **Avoid body contact with earthed or grounded surfaces, such as pipes, radiators, ranges and refrigerators.**  
*There is an increased risk of electric shock if your body is earthed or grounded.*
- c) **Do not expose power tools to rain or wet conditions.**  
*Water entering a power tool will increase the risk of electric shock.*
- d) **Do not abuse the cord. Never use the cord for carrying, pulling or unplugging the power tool. Keep cord away from heat, oil, sharp edges or moving parts.**  
*Damaged or entangled cords increase the risk of electric shock.*
- e) **When operating a power tool outdoors, use an extension cord suitable for outdoor use.**  
*Use of a cord suitable for outdoor use reduces the risk of electric shock.*
- f) **If operating a power tool in a damp location is unavoidable, use a residual current device (RCD) protected supply.**  
*Use of an RCD reduces the risk of electric shock.*

#### 3) Personal safety

- a) **Stay alert, watch what you are doing and use common sense when operating a power tool. Do not use a power tool while you are tired or under the influence of drugs, alcohol or medication.**  
*A moment of inattention while operating power tools may result in serious personal injury.*
- b) **Use personal protective equipment. Always wear eye protection.**  
*Protective equipment such as dust mask, non-skid safety shoes, hard hat, or hearing protection used for appropriate conditions will reduce personal injuries.*
- c) **Prevent unintentional starting. Ensure the switch is in the off position before connecting to**

**power source and/or battery pack, picking up or carrying the tool.**

*Carrying power tools with your finger on the switch or energising power tools that have the switch on invites accidents.*

- d) **Remove any adjusting key or wrench before turning the power tool on.**  
*A wrench or a key left attached to a rotating part of the power tool may result in personal injury.*
  - e) **Do not overreach. Keep proper footing and balance at all times.**  
*This enables better control of the power tool in unexpected situations.*
  - f) **Dress properly. Do not wear loose clothing or jewellery. Keep your hair, clothing and gloves away from moving parts.**  
*Loose clothes, jewellery or long hair can be caught in moving parts.*
  - g) **If devices are provided for the connection of dust extraction and collection facilities, ensure these are connected and properly used.**  
*Use of dust collection can reduce dust-related hazards.*
- #### 4) Power tool use and care
- a) **Do not force the power tool. Use the correct power tool for your application.**  
*The correct power tool will do the job better and safer at the rate for which it was designed.*
  - b) **Do not use the power tool if the switch does not turn it on and off.**  
*Any power tool that cannot be controlled with the switch is dangerous and must be repaired.*
  - c) **Disconnect the plug from the power source and/or the battery pack from the power tool before making any adjustments, changing accessories, or storing power tools.**  
*Such preventive safety measures reduce the risk of starting the power tool accidentally.*
  - d) **Store idle power tools out of the reach of children and do not allow persons unfamiliar with the power tool or these instructions to operate the power tool.**  
*Power tools are dangerous in the hands of untrained users.*
  - e) **Maintain power tools. Check for misalignment or binding of moving parts, breakage of parts and any other condition that may affect the power tool's operation. If damaged, have the power tool repaired before use.**  
*Many accidents are caused by poorly maintained power tools.*
  - f) **Keep cutting tools sharp and clean.**  
*Properly maintained cutting tools with sharp cutting edges are less likely to bind and are easier to control.*
  - g) **Use the power tool, accessories and tool bits etc. in accordance with these instructions, taking into account the working conditions and the work to be performed.**  
*Use of the power tool for operations different from those intended could result in a hazardous situation.*
- #### 5) Battery tool use and care
- a) **Recharge only with the charger specified by the manufacturer.**  
*A charger that is suitable for one type of battery pack may create a risk of fire when used with another battery pack.*
  - b) **Use power tools only with specifically designated battery packs.**  
*Use of any other battery packs may create a risk of injury and fire.*

- c) **When battery pack is not in use, keep it away from other metal objects, like paper clips, coins, keys, nails, screws or other small metal objects, that can make a connection from one terminal to another.**

*Shorting the battery terminals together may cause burns or a fire.*

- d) **Under abusive conditions, liquid may be ejected from the battery; avoid contact. If contact accidentally occurs, flush with water. If liquid contacts eyes, additionally seek medical help.**

*Liquid ejected from the battery may cause irritation or burns.*

**6) Service**

- a) **Have your power tool serviced by a qualified repair person using only identical replacement parts.**

*This will ensure that the safety of the power tool is maintained.*

**PRECAUTION**

**Keep children and infirm persons away. When not in use, tools should be stored out of reach of children and infirm persons.**

**CORDLESS FINISH NAILER / BRAD NAILER SAFETY WARNINGS**

- 1. Always assume that the tool contains fasteners.**  
Careless handling of the nailer can result in unexpected firing of fasteners and personal injury.
- 2. Do not point the tool towards yourself or anyone nearby.**  
Unexpected triggering will discharge the fastener causing an injury.
- 3. Do not actuate the tool unless the tool is placed firmly against the workpiece.**  
If the tool is not contact with the workpiece, the fastener may be deflected away from your target.
- 4. Disconnect the tool from the power source when the fastener jams in the tool.**  
While removing a jammed fastener, the nailer may be accidentally activated if it is plugged in.
- 5. Use caution while removing a jammed fastener.**  
The mechanism may be under compression and the fastener may be forcefully discharged while attempting to free a jammed condition.
- 6. Do not use this nailer for fastening electrical cables.**  
It is not designed for electric cable installation and may damage the insulation of electric cables thereby causing electric shock or fire hazards.

**ADDITIONAL SAFETY WARNINGS**

- 1. Safe operation through correct usage.**  
This tool was designed for driving nails into wood and similar materials. Use it for its intended purpose only.
- 2. Be careful of ignition and explosions.**  
Since sparks may fly during nailing, it is dangerous to use this tool near lacquer, paint, benzine, thinner, gasoline, gas, adhesives and similar inflammable substances as they may ignite or explode. Under no circumstances should this tool therefore be used in the vicinity of such inflammable material.
- 3. Always wear eye protection (protective goggles).**



When operating the power tool, always wear eye protection, and ensure that surrounding people wear eye protection too. Eye protection should not be inferior to the specification set in AS/NZS 1337 Eye protectors for industrial applications.

The possibility of fragments of the nails that were not properly hit entering the eye is a threat to sight. Always wear eye protection while operating this tool. Use either eye protection or a wide vision mask over prescription glasses.

Employers should always enforce the use of eye protection equipment.

**4. Protect your ears and head.**

When engaged in nailing work please wear ear muffs and head protection. Also, depending on condition, ensure that surrounding people also wear ear muffs and head protection. Hearing protection equipment should be of a reputable make and manufactured to an acceptable standard, for example AS/NZS 1270 Acoustics-Hearing protectors.

**5. Pay attention to those working close to you.**

It would be very dangerous if nails that were not properly driven in should hit other people. Therefore, always pay attention to the safety of the people around you when using this tool. Always make sure that nobody's body, hands or feet are close to the nail outlet.

**6. Never point the nail outlet towards people.**



Always assume the tool contains fasteners.

If the nail outlet is pointed towards people, serious accidents may be caused if you mistakenly discharge the tool. When connecting and disconnecting the battery, during nail loading or similar operations, be sure the nail outlet is not pointed towards anyone (including yourself). Even when no nails are loaded at all, it is dangerous to discharge the tool while pointing it at someone, so never attempt to do so. No horseplay. Respect the tool as a working implement.

**7. Check push lever before use.**

Make sure the push lever operates properly. (The push lever may be called "Safety".) Never use the Nailer unless the push lever is operating properly, otherwise the Nailer could drive a fastener unexpectedly. Do not tamper with or remove the push lever, otherwise the push lever becomes inoperable.

**8. Choice of triggering method is important.**

Read and understand section titled "HOW TO USE THE NAILER" on page 13.

**9. Prior to using this product, make sure that it is operating properly in accordance with the content of "Testing the nailer" on page 11.**

**10. Use specified nails only.**

Never use nails other than those specified and described in these instructions.

**11. Be careful when connecting the battery.**

When connecting the battery and loading nails in order not to fire the tool by mistake, make sure of the followings.

- Do not touch the trigger.
- Do not allow the firing head to contact with any surface.
- Keep the firing head down.

Strictly observe the above instructions, and always make sure that no part of the body, hands or legs is ever in front of the nail outlet.

**12. Do not carelessly place your finger on the trigger.**

Do not place your finger on the trigger except when actually nailing. If you carry this tool or hand it to someone while having your finger on the trigger, you may inadvertently discharge a nail and thus cause an accident.

**13. Press the nail outlet firmly against the material to be nailed.**

When driving in nails, press the nail outlet firmly against the material to be nailed. If the outlet is not applied properly, the nails may rebound.

**14. Keep hands and feet away from the firing head when using.**



It is very dangerous for a nail to hit the hands or feet by mistake.

**15. Beware of the tool's kickback.**

Do not approach the top of the tool with your head etc. during operation. This is dangerous because the tool may recoil violently if the nail currently being driven in comes into contact with a previous nail or a knot in the wood.

**16. Be careful of double fire due to recoil.**

If the push lever is unintentionally allowed to re-contact the workpiece following recoil, an unwanted fastener will be driven.

In order to avoid this undesirable double fire,

- Intermittent operation (Trigger firing)
  - 1) Set the switching device to FULL SEQUENTIAL ACTUATION MECHANISM.
  - 2) Pull the trigger rapidly and firmly.
- Continuous operation (Push lever firing) (New Zealand models of NT1865DBAL and NT1865DBSL specifications excluded)
  - 1) Do not press the nailer against the wood with excessive force.
  - 2) Separate the nailer from the wood as it recoils after fastening.

**17. Take care when nailing thin boards or the corners of wood.**

When nailing thin boards, the nails may pass right through, as may also be the case when nailing the corners of wood due to deviation of the nails. In such cases, always make sure that there is no one (and nobody's hands or feet; etc.) behind the thin board or next to the wood you are going to nail.

**18. Simultaneous nailing on both sides of the same wall is dangerous.**

Under no circumstances should nailing be performed on both sides of a wall at the same time. This would be very dangerous since the nails might pass through the wall and thus cause injuries.

**19. Do not use the power tool on scaffoldings, ladders.**

The power tool shall not be used for specific application for example:

- when changing one driving location to another involves the use of scaffoldings, stairs, ladders or ladder alike constructions, e.g. roof laths,
- closing boxes or crates,
- fitting transportation safety systems e.g. on vehicles and wagons

**20. Remove all remaining fasteners and battery from nailer when:**

- 1) doing maintenance and inspection;
- 2) checking proper operation of push lever and trigger;
- 3) attaching or removing the nose cap;
- 4) clearing a jam;
- 5) it is not in use;
- 6) leaving work area;
- 7) moving it to another location; and
- 8) handing it to another person.

Never attempt to clear a jam or repair the Nailer unless you have removed battery and all remaining fasteners from the Nailer.

The Nailer should never be left unattended since people who are not familiar with the Nailer might handle it and injure the themselves.

**21. Remove battery from nailer when:**

- 1) loading nails;
- 2) turning the adjuster.

**22. Disconnect the battery.**

When attaching and detaching the nose cap, disconnect the battery.

When attaching the accessory nose cap to the tip of the push lever and when detaching it, make sure to disconnect the battery beforehand. It is very dangerous for a nail to be fired by mistake.

**23. The operating environment for this device is between 0°C and 40°C so ensure use within this temperature range. The device may fail to operate below 0°C or above 40°C.**

**24. Always charge the battery at an ambient temperature of 0–40°C.**

A temperature of less than 0°C will result in over charging which is dangerous. The battery cannot be charged at a temperature greater than 40°C.

The most suitable temperature for charging is that of 20–25°C.

**25. Do not use the charger continuously.**

When one charging is completed, leave the charger for about 15 minutes before the next charging of battery.

**26. Do not allow foreign matter to enter the hole for connecting the rechargeable battery.**

**27. Never disassemble the rechargeable battery or charger.**

**28. Never short-circuit the rechargeable battery.**

Short-circuiting the battery will cause a great electric current and overheat. It results in burn or damage to the battery.

**29. Do not dispose of the battery in fire.**

If the battery is burnt, it may explode.

**30. Using an exhausted battery will damage the charger.**

**31. Bring the battery to the shop from which it was purchased as soon as the post-charging battery life becomes too short for practical use.**

Do not dispose of the exhausted battery.

**32. Do not insert objects into the air ventilation slots of the charger.**

Inserting metal objects or flammable into the charger air ventilation slots will result in an electrical shock hazard or damage to the charger.

**33. NEVER allow magnets (or similar magnetic devices) to be adjacent to the nailer, because the nailer has a magnetic sensor inside.**

Doing so will cause a failure or risk of injury by malfunction.

**34. Resting the unit after continuous work.**

**35. The power tool is equipped with a temperature protection circuit to protect the motor. Continuous work may cause the temperature of the unit to rise, activating the temperature protection circuit and automatically stopping operation. If this happens, allow the power tool to cool before resuming use.**

**36. This product may cease to operate when an abnormality is detected. In such cases, check the items listed under "TROUBLESHOOTING" on page 15.**

**37. Do not give a strong shock to the switch panel or break it. It may lead to a trouble.**

**38. When transporting the nailer, it should be stored in the provided case or a sturdy container such as a packing box to avoid accidental damage. In addition, the handling instructions and maintenance tools should be stored in the same container with the tool.**

## CAUTION ON LITHIUM-ION BATTERY

To extend the lifetime, the lithium-ion battery equips with the protection function to stop the output.

In the cases of 1 to 3 described below, when using this product, even if you are pulling the switch, the motor may stop. This is not the trouble but the result of protection function.

1. When the battery power remaining runs out, the motor stops.  
In such a case, charge it up immediately.
2. If the tool is overloaded, the motor may stop. In this case, release the switch of tool and eliminate causes of overloading. After that, you can use it again.
3. If the battery is overheated under overload work, the battery power may stop.  
In this case, stop using the battery and let the battery cool. After that, you can use it again.

Furthermore, please heed the following warning and caution.

#### WARNING

In order to prevent any battery leakage, heat generation, smoke emission, explosion and ignition beforehand, please be sure to heed the following precautions.

1. Make sure that swarf and dust do not collect on the battery.
- During work make sure that swarf and dust do not fall on the battery.
- Make sure that any swarf and dust falling on the power tool during work do not collect on the battery.
- Do not store an unused battery in a location exposed to swarf and dust.
- Before storing a battery, remove any swarf and dust that may adhere to it and do not store it together with metal parts (screws, nails, etc.).
2. Do not pierce battery with a sharp object such as a nail, strike with a hammer, step on, throw or subject the battery to severe physical shock.
3. Do not use an apparently damaged or deformed battery.
4. Do not use the battery in reverse polarity.
5. Do not connect directly to an electrical outlets or car cigarette lighter sockets.
6. Do not use the battery for a purpose other than those specified.
7. If the battery charging fails to complete even when a specified recharging time has elapsed, immediately stop further recharging.
8. Do not put or subject the battery to high temperatures or high pressure such as into a microwave oven, dryer, or high pressure container.
9. Keep away from fire immediately when leakage or foul odor are detected.
10. Do not use in a location where strong static electricity generates.
11. If there is battery leakage, foul odor, heat generated, discolored or deformed, or in any way appears abnormal during use, recharging or storage, immediately remove it from the equipment or battery charger, and stop use.
12. Do not immerse the battery or allow any fluids to flow inside. Conductive liquid ingress, such as water, can cause damage resulting in fire or explosion. Store your battery in a cool, dry place, away from combustible and flammable items. Corrosive gas atmospheres must be avoided.

#### CAUTION

1. If liquid leaking from the battery gets into your eyes, do not rub your eyes and wash them well with fresh clean water such as tap water and contact a doctor immediately.  
If left untreated, the liquid may cause eye-problems.
2. If liquid leaks onto your skin or clothes, wash well with clean water such as tap water immediately.  
There is a possibility that this can cause skin irritation.
3. If you find rust, foul odor, overheating, discolor, deformation, and/or other irregularities when using the battery for the first time, do not use and return it to your supplier or vendor.

#### WARNING

If a conductive foreign matter enters in the terminal of lithium ion battery, the battery may be shorted, causing fire. When

storing the lithium ion battery, obey surely the rules of following contents.

- Do not place conductive debris, nail and wires such as iron wire and copper wire in the storage case.
- To prevent shorting from occurring, load the battery in the tool or insert securely the battery cover for storing until the ventilator is not seen.

## REGARDING LITHIUM-ION BATTERY TRANSPORTATION

When transporting a lithium-ion battery, please observe the following precautions.

#### WARNING

Notify the transporting company that a package contains a lithium-ion battery, inform the company of its power output and follow the instructions of the transportation company when arranging transport.

- Lithium-ion batteries that exceed a power output of 100Wh are considered to be in the freight classification of Dangerous Goods and will require special application procedures.
- For transportation abroad, you must comply with international law and the rules and regulations of the destination country.

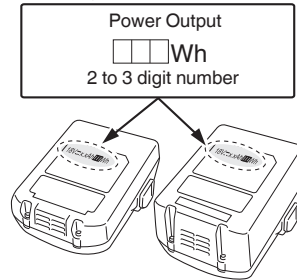

## USB DEVICE CONNECTION PRECAUTIONS (UC18YSL3)

When an unexpected problem occurs, the data in a USB device connected to this product may be corrupted or lost. Always make sure to back up any data contained in the USB device prior to use with this product.

Please be aware that our company accepts absolutely no responsibility for any data stored in a USB device that is corrupted or lost, nor for any damage that may occur to a connected device.

#### WARNING

- Prior to use, check the connecting USB cable for any defect or damage.  
Using a defective or damaged USB cable can cause smoke emission or ignition.
- When the product is not being used, cover the USB port with the rubber cover.  
Buildup of dust etc. in the USB port can cause smoke emission or ignition.

#### NOTE

- There may be an occasional pause during USB recharging.
- When a USB device is not being charged, remove the USB device from the charger.  
Failure to do so may not only reduce the battery life of a USB device, but may also result in unexpected accidents.
- It may not be possible to charge some USB devices, depending on the type of device.





## NAMES OF PARTS (Fig. 1 – Fig. 30)























①	Top cover
②	Trigger
③	LED light
④	Firing head (outlet)
⑤	Push lever
⑥	Nail feeder (A)
⑦	Nail feeder (B)
⑧	Magazine
⑨	Hook
⑩	Battery
⑪	Switch lock lever
⑫	Handle
⑬	Stop lever
⑭	Battery indicator switch
⑮	Battery indicator
⑯	Nailing operation switch (New Zealand models of NT1865DBAL and NT1865DBSL specifications excluded)
⑰	Power indicator
⑱	Power switch
⑲	Nailing operation indicator
⑳	Nail strip
㉑	Magazine cover
㉒	Groove
㉓	Blade guide
㉔	Adjuster
㉕	Hook plate
㉖	Nose cap
㉗	Lock lever
㉘	Guide plate

## SYMBOLS

### WARNING

The following show symbols used for the machine.  
Be sure that you understand their meaning before use.

	NT 1865DBAL: Cordless Finish Nailer NT 1865DBSL: Cordless Finish Nailer NT 1850DBSL: Cordless Brad Nailer
	To reduce the risk of injury, user must read instruction manual
	Direct current
	Weight

	Switching ON
	Switching OFF
	Disconnect the battery
	Power switch
	Power switch OFF
	Power switch ON Power indicator: Light in green
	Nailing operation switch (New Zealand models of NT1865DBAL and NT1865DBSL specifications excluded)
	FULL SEQUENTIAL ACTUATION MECHANISM
	FULL SEQUENTIAL ACTUATION MECHANISM mode Nailing operation indicator: Light in blue
	FULL SEQUENTIAL ACTUATION MECHANISM mode (New Zealand models of NT1865DBAL and NT1865DBSL specifications excluded) Nailing operation indicator: Light in blue
	CONTACT ACTUATION MECHANISM (New Zealand models of NT1865DBAL and NT1865DBSL specifications excluded)
	CONTACT ACTUATION MECHANISM mode Nailing operation indicator: Blink in blue (New Zealand models of NT1865DBAL and NT1865DBSL specifications excluded)
	Trigger locked
	Trigger unlocked
	Battery indicator switch
	The battery remaining power is enough Battery indicator: 2 LEDs (Red) light
	The battery remaining power is about half. Battery indicator: 1 LED (Red) lights
	The battery remaining power is nearly empty. Recharge the battery as soon as possible. Battery indicator: 1 LED (Red) blink
	Contact HiKOKI for inspection. Battery indicator: 2 LEDs blink in Orange, after 10 seconds, automatically turn off Power switch.
	Shallow side
	Deep side
	Warning
	Prohibited action

## SPECIFICATIONS

### 1. Cordless Finish Nailer

Model		NT1865DBAL		NT1865DBSL	
Motor		DC Brushless		DC Brushless	
Applicable Nail		15 Ga		16 Ga	
Applicable Nail Length		32 mm to 65 mm		25 mm to 65 mm	
Nail Loading capacity [nails]		100 (1 strip)		100 (2 strips)	
Firing mode		Full sequential / Contact (Selectable) **		Full sequential / Contact (Selectable) **	
Cycle rate	[nails/second]	3 (Intermittent)		3 (Intermittent)	
Battery	Model	BSL1830C	BSL1860	BSL1830C	BSL1860
	Type	Li-ion battery			
	Voltage	DC 18V			
Weight		3.5 kg	3.8 kg	3.4 kg	3.6 kg
Dimension Height × Length × Width		344 mm × 300 mm × 104 mm	344 mm × 310 mm × 104 mm	315 mm × 298 mm × 104 mm	315 mm × 310 mm × 104 mm

### 2. Cordless Brad Nailer

Model		NT1850DBSL	
Motor		DC Brushless	
Applicable Nail		18 Ga	
Applicable Nail Length		16mm to 50mm *	
Nail Loading capacity [nails]		100 (1 strip)	
Firing mode		Full sequential / Contact (Selectable)	
Cycle rate	[nails/second]	3 (Intermittent)	
Battery	Model	BSL1830C	BSL1860
	Type	Li-ion battery	
	Voltage	DC 18V	
Weight		3.3 kg	3.6 kg
Dimension Height × Length × Width		323 mm × 298 mm × 104 mm	323 mm × 310 mm × 104 mm

\* Excluding nails that measure 35mm in length

\*\*Only full sequential mode is available for New Zealand models of NT1865DBAL and NT1865DBSL specifications

### 3. Battery Charger

Model	UC18YSL3
Charging voltage	DC 14.4 – 18 V
Weight	0.6 kg





## NOTE

Due to HiKOKI's continuing program of research and development, the specifications herein are subject to change without prior notice.

## NAIL SELECTION

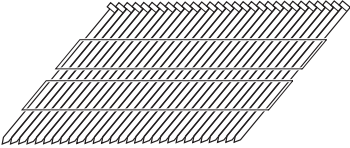
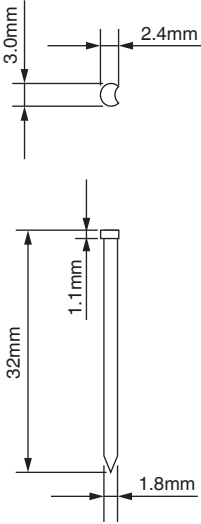
Only nails shown in the Table below can be driven with this Nailer.

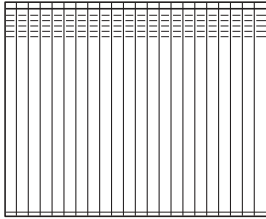
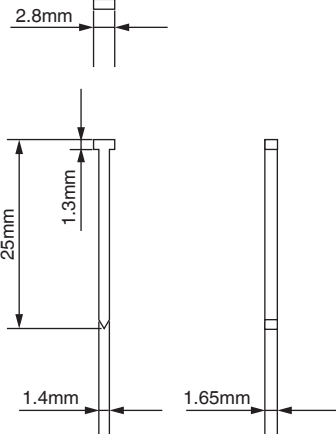
Dimensions of nails

	Min.	Max.
<p>15 Gauge finish nails (Angle: 34°)</p> 		
<p>16 Gauge finish nails (straight)</p> 		



<NT1850DBSL>

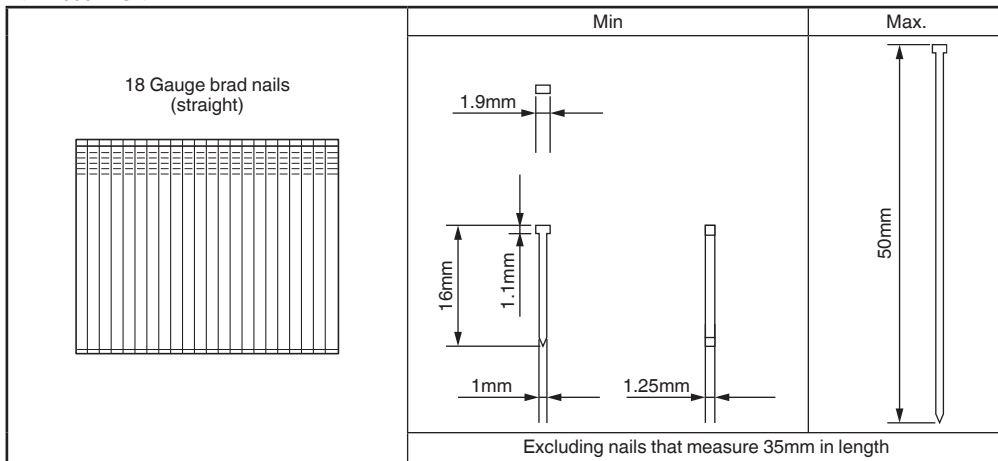

**STANDARD ACCESSORIES**

In addition to the main unit (1 unit), the package contains the accessories listed on page 17.

Standard accessories are subject to change without notice.

**APPLICATIONS**

<NT1865DBAL, NT1865DBSL>

- Nailing as finishing process for areas around the doors, windows as well as edgings.
- Securing the bottom of drawers. Making various cases and cabinets.

<NT1850DBSL>

- Cabinet and picture frame assembly, furniture trim.
- On-site and mobile home trim and molding.

**CHARGING**

Before using the power tool, charge the battery as follows.

1. **Connect the charger's power cord to the receptacle.**  
When connecting the plug of the charger to a receptacle, the pilot lamp will blink in red (At 1- second intervals).
2. **Insert the battery into the charger.**  
Firmly insert the battery into the charger as shown in Fig. 2 (on page 18).
3. **Charging**

When inserting a battery in the charger, the charge indicator lamp will blink in blue.

When the battery becomes fully recharged, the charge indicator lamp will light up in green. (See Table 3)

(1) Charge indicator lamp indication

The indications of the charge indicator lamp will be as shown in Table 3, according to the condition of the charger or the rechargeable battery.

**Table 3**

Indications of the charge indicator lamp				
Charge indicator lamp (RED / BLUE / GREEN / PURPLE)	Before charging	Blinks (RED)	Lights for 0.5 seconds. Does not light for 0.5 seconds. (off for 0.5 seconds)	Plugged into power source
	While charging	Blinks (BLUE)	Lights for 0.5 seconds. Does not light for 1 second. (off for 1 second)	Battery capacity at less than 50%
		Blinks (BLUE)	Lights for 1 second. Does not light for 0.5 seconds. (off for 0.5 seconds)	Battery capacity at less than 80%
		Lights (BLUE)	Lights continuously	Battery capacity at more than 80%
	Charging complete	Lights (GREEN)	Lights continuously (Continuous buzzer sound: about 6 seconds)	
	Overheat standby	Blinks (RED)	Lights for 0.3 seconds. Does not light for 0.3 seconds. (off for 0.3 seconds)	Battery overheated. Unable to charge. (Charging will commence when battery cools)
	Charging impossible	Flickers (PURPLE)	Lights for 0.1 seconds. Does not light for 0.1 seconds. (Intermittent buzzer sound: about 2 seconds)	Malfunction in the battery or the charger

- (2) Regarding the temperatures and charging time of the rechargeable battery  
The temperatures and charging time will become as shown in **Table 4**.

**Table 4**

Battery		Charger	UC18YSL3	
Charging voltage		V	14.4	18
Type of battery			Li-ion	
Temperatures at which the battery can be recharged			-10°C – 50°C	
Charging time for battery capacity, approx. (At 20°C)				
1.3 Ah	min.	15 (4 cells)		15 (5 cells)
1.5 Ah	min.	15 (4 cells)		15 (5 cells)
2.0 Ah	min.	20 (4 cells)		20 (5 cells)
2.5 Ah	min.	25 (4 cells)		25 (5 cells)
3.0 Ah	min.	20 (8 cells) / 30 * BSL1430C		20 (10 cells) / 30 * BSL1830C
4.0 Ah	min.	26 (8 cells)		26 (10 cells)
5.0 Ah	min.	32 (8 cells)		32 (10 cells)
6.0 Ah	min.	38 (8 cells)		38 (10 cells)

**NOTE**

The recharging time may vary according to the ambient temperature and power source voltage.

- 4. Disconnect the charger's power cord from the receptacle.**

- 5. Hold the charger firmly and pull out the battery.**

**NOTE**

Be sure to pull out the battery from the charger after use, and then keep it.

**Regarding electric discharge in case of new batteries, etc.**

As the internal chemical substance of new batteries and batteries that have not been used for an extended period is not activated, the electric discharge might be low when using them the first and second time. This is a temporary phenomenon, and normal time required for recharging will be restored by recharging the batteries 2 – 3 times.

**How to make the batteries perform longer.**

- (1) Recharge the batteries before they become completely exhausted.

When you feel that the power of the tool becomes weaker, stop using the tool and recharge its battery. If you continue to use the tool and exhaust the electric current, the battery may be damaged and its life will become shorter.

- (2) Avoid recharging at high temperatures.

A rechargeable battery will be hot immediately after use. If such a battery is recharged immediately after use, its internal chemical substance will deteriorate, and the battery life will be shortened. Leave the battery and recharge it after it has cooled for a while.

**CAUTION**

- If the battery is charged while it is heated because it has been left for a long time in a location subject to direct sunlight or because the battery has just been used, the charge indicator lamp of the charger lights for 0.3 seconds, does not light for 0.3 seconds (off for 0.3 seconds). In such a case, first let the battery cool, then start charging.
- When the charge indicator lamp flickers (at 0.2-second intervals), check for and take out any foreign objects in the charger's battery connector. If there are no foreign objects, it is probable that the battery or charger is malfunctioning. Take it to your authorized Service Center.

- Since the built-in micro computer takes about 3 seconds to confirm that the battery being charged with UC18YSL3 is taken out, wait for a minimum of 3 seconds before reinserting it to continue charging. If the battery is reinserted within 3 seconds, the battery may not be properly charged.

**BEFORE USE**

Action	Figure	Page
Removing and inserting the battery	2	18
Charging	3	19
Charging a USB device from a electrical outlet	28-a	23
Charging a USB device and battery from a electrical outlet	28-b	23
How to recharge USB device	29	24
When charging of USB device is completed	30	24
Selecting accessories	—	25

**1. How to operate operation panel**

- (1) Power switch ON (See Fig. 4)

Under the condition of "Power switch OFF", push and hold on Power switch more than 1 second, then power indicator lights in Green.

**NOTE**

Do not press the push lever and/or pull the trigger during the process of turning the power switch ON.

Doing so will prevent the power switch from turning ON.

[Auto power off]

When the power is turned on but the Nailer is not used for 30 minutes, the Nailer is automatically turned off. To turn on again, press the power switch.

**WARNING**

Never leave the Nailer with the power on. This could result in an accident.

- (2) Power switch OFF (See Fig. 4)

Under the condition of "Power switch ON", push and hold on Power switch more than 1 second, then power indicator goes off.

Under the condition of "Power switch ON", functions below are active.

- (3) Select Nailing operation mode  
(Full sequential actuation / Contact actuation)  
After power switch turn ON, always set in Full sequential actuation mode as initial. (Nailing operation indicator light in blue.) (See Fig. 5)

To change nailing operation mode, push Nailing operation switch once. Every pushing, mode will change between "Full sequential" and "Contact". (See Fig. 6)  
Lighting (Blue):



FULL SEQUENTIAL ACTUATION MECHANISM,  
Blinking (Blue):  
CONTACT ACTUATION MECHANISM

#### NOTE

New Zealand models of NT1865DBAL and NT1865DBSL specifications are only equipped for full sequential actuation mechanism mode and the nailing operation mode cannot be switched. These New Zealand models are not equipped with a nailing operation switch.

- (4) Check Remaining battery level

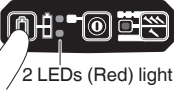
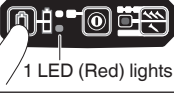
When pressing the battery indicator switch, the battery indicator shows Remaining battery level by status of LED lamp as below.

Status of indicator	
 2 LEDs (Red) light	The battery remaining power is enough.
 1 LED (Red) lights	The battery remaining power is about half.
 1 LED (Red) blinks	The battery remaining power is nearly empty. Recharge the battery as soon as possible.

- (5) Other functions

In case of operation error, LED lamps show as below.

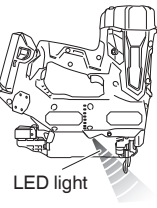
Status of indicator	
 LED light	Machine is in too cold (below -5°C or too hot condition). Allow the nailer to cool or warm-up thoroughly in adequate condition.
LED light blink in an interval. • In case of too hot condition, Blink in 1 second interval. • In case of too cold condition, Blink in 0.5 second interval. After 10 seconds, automatically turn off LED light and Power switch.	

	Contact HiKOKI for inspection.
2 LEDs blink in Orange, after 10 seconds, automatically turn off Power switch.	

- (6) How to use the LED light (See Fig. 7)



While the power switch on, the LED light will automatically light up the tip portion of the tool.

#### CAUTION

- Do not expose directly your eye to the light by looking into the light.  
If your eye is continuously exposed to the light, your eye will be hurt.
- Wipe off any dirt or grime attached to the lens of the LED light with a soft cloth, being careful not to scratch the lens.  
Scratches on the lens of the LED light can result in decreased brightness.

#### 2. Trigger Lock Mechanism (See Fig. 8)

##### WARNING

Make sure the trigger is locked when not firing nails.  
This Nailers has a lock mechanism to prevent the nails from being fired.  
Set the switch lock lever at the  position to lock the trigger.  
Slide the switch lock lever to the  position when the Nailers is to be used, and to the  position when it is not in use.

#### 3. Testing the nailer

##### WARNING

- Make sure the trigger is locked when not firing nails. (See Fig. 8)
- Never use Nailers unless push lever is operating properly. The machine employs a preventive mechanism for unloaded operation.  
The machine enters a state where the push lever cannot be pushed up. This takes place when the magazine is not loaded with nails or when the remaining number of nails becomes less than 6 or 9.

#### CAUTION

Use caution not to throw the push lever tip onto wood.  
Before actually beginning the nailing work, test the Nailers by using the checklist below. Conduct the tests in the following order.

If abnormal operation occurs, stop using the Nailers and contact a HiKOKI authorized service center immediately.

- (1) REMOVE ALL NAILS AND BATTERY FROM NAILER.
  - ALL SCREWS MUST BE TIGHTENED.
  - THE PUSH LEVER AND TRIGGER MUST MOVE SMOOTHLY with pulling back the nail feeder (B). (NT1850DBSL: Unnecessary to pulling back nail feeder)
- (2) Installing the battery.  
Do not operate the push lever or trigger while installing the battery. (See Fig. 2)
- (3) Turn on the Power switch. (See Fig. 1)  
Turn on the Power switch by push and hold on Power switch more than 1 second.  
Make sure the power indicator is lighting in green, and nailing operation indicator is lighting in blue. (FULL SEQUENTIAL ACTUATION MECHANISM)

#### NOTE

Do not press the push lever and/or pull the trigger during the process of turning the power switch ON.  
Doing so will prevent the power switch from turning ON.

[Auto power off]

When the power is turned on but the Nailer is not used for 30 minutes, the Nailer is automatically turned off. To turn on again, press the power switch.

#### WARNING

Never leave the Nailer with the power on. This could result in an accident.

Nailing operation indicator

Lighting (Blue):

FULL SEQUENTIAL ACTUATION MECHANISM,

Blinking (Blue):

CONTACT ACTUATION MECHANISM

(New Zealand models of NT1865DBAL and NT1865DBSL specifications excluded)

Make sure the battery indicator is not blinking.

If the battery indicator is blinking in red, the battery doesn't have enough power and it needs to be charged.

- (4) Remove the finger from the trigger and press the push lever against the workpiece with pulling back the nail feeder (B).

THE NAILER MUST NOT OPERATE.

- (5) Separate the push lever from the workpiece.

Next, point the nailer downward, with pulling back the nail feeder (B), pull the trigger and then wait in that position for 5 seconds or longer.

THE NAILER MUST NOT OPERATE.

- (6) ① Without touching the trigger, depress the push lever against the workpiece with pulling back the nail feeder (B).

Next, pull the trigger.

THE NAILER MUST OPERATE.

- ② Hold the trigger back and depress the push lever against the workpiece again.

THE NAILER MUST NOT OPERATE.

- ③ Separate the finger from the trigger.

Next, ① is operated again.

THE NAILER MUST OPERATE.

- (7) Separate the push lever from the workpiece, pull the trigger.

Depress the push lever against the workpiece within 2 seconds.

THE NAILER MUST NOT OPERATE.

- (8) (New Zealand models of NT1865DBAL and NT1865DBSL specifications excluded)

Set the nailing operation indicator blinking ON mode. (CONTACT ACTUATION MECHANISM)

Push the nailing operation switch once, make sure that the indicator is blinking Blue.

Separate the push lever from the workpiece, pull the trigger.

Depress the push lever against the workpiece within 2 seconds.

THE NAILER MUST OPERATE.

- (9) If no abnormal operation is observed, you may load nails in the Nailer.

Drive nails into the workpiece that is the same type to be used in the actual application.

THE NAILER MUST OPERATE PROPERLY.

#### 4. Checking push lever operations

##### WARNING

Make sure the trigger is locked when not firing nails.

Always make sure the trigger is locked and the battery removed from the power tool when checking push lever operations.

Check to make sure the push lever slides smoothly when operated.

Clean the sliding area on the push lever if it doesn't slide smoothly.

#### 5. Load nails

##### WARNING

When loading nails into Nailer,

1) remove battery from the nailer;

2) do not pull trigger;

3) do not depress push lever; and

4) keep nailer pointed downward.

<NT1865DBAL, NT1865DBSL>

2-Action Nail Feeding!

- (1) Insert nail strip into the back of the magazine. (See Fig. 9)

- (2) Slide the nail strip forward in the magazine. (See Fig. 10)

- (3) Push the nail feeder (A) to engage the nail feeder (B) to the nail strip. (See Fig. 11)

##### NOTE

○ Quietly push the nail feeder (A) and nail feeder (B) against the nail.

If the nail feeder (A) and nail feeder (B) are released from backward the magazine and bumped against the nail, the connecting adhesive of the nail can be damaged.

○ Use nail strip of more than 10 nails.

○ Use an unbroken nail strip with nails of all the same length.

The Nailer is now ready to operate.

Removing the nails:

- ① Pull the nail feeder (B) backward. (See Fig. 12)

- ② Return the nail feeder (B) forward quietly while pushing the nail feeder (A).

- ③ Pull out nails from the back of the magazine. (See Fig. 13)

<NT1850DBSL>

- (1) Lightly press the stop lever and gently pull out the magazine cover. (See Fig. 14)

- (2) Set nail strip into the magazine and keep the points of nails in contact with Groove. (See Fig. 15)

##### NOTE

The nails shown in page 9 can be loaded onto the side guide groove of the magazine without any adjustment.

Always keep the points of nails in contact with Groove.

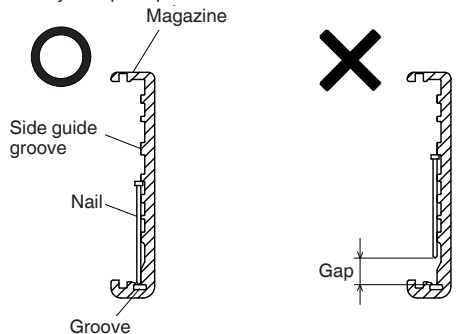

- (3) Slide the nail strip into the blade guide. (See Fig. 16)

- (4) Confirm that nail strip is placed with side guide grooves and Groove properly, then push the magazine cover forward to be latched.

## HOW TO USE THE NAILER

### WARNING

- NEVER point tool at yourself or others in work area.
- Keep fingers AWAY from trigger when not driving nails to avoid accidental firing.
- Do not use the electrical cord if damaged. Have it repaired immediately.
- Choice of triggering method is important. Please read and understand "1. Nailing procedures" found below.
- Before starting work, check the nailing operation switching device. This HiKOKI nailer includes a nailing operation switching device. Before starting work, make sure that the switching device is properly set. If the switching device is not set properly, the nailer will not operate correctly.
- Never place your face, hands or feet near firing head when using.
- Do not drive nails on top of other nails or with Nailer at too steep of an angle; nails can ricochet and hurt someone.
- Do not drive nails into thin boards or near corners and edges of workpiece. Nails can be driven through or away from workpiece and hit someone.
- Never drive nails from both sides of a wall at the same time. Nails can be driven into and through the wall and hit a person on the opposite side.
- Never use Nailer which is defective or operating abnormally.
- Do not use Nailer as hammer.
- Remove all remaining fasteners and battery from nailer when:
  - 1) doing maintenance and inspection;
  - 2) checking proper operation of push lever and trigger;
  - 3) attaching or removing the nose cap;
  - 4) cleaning a jam;
  - 5) it is not in use;
  - 6) leaving work area;
  - 7) moving it to another location; and
  - 8) handing it to another person.
- Remove battery from Nailer when:
  - 1) loading nails;
  - 2) turning the adjuster.

This HiKOKI nailer is equipped with a nailer operation switching device.

Use FULL SEQUENTIAL ACTUATION MECHANISM or CONTACT ACTUATION MECHANISM in accordance with the work to be performed.

### NOTE

New Zealand models of NT1865DBAL and NT1865DBSL specifications are only equipped for the FULL SEQUENTIAL ACTUATION MECHANISM.

Explanation of the various nailing operations

- FULL SEQUENTIAL ACTUATION MECHANISM:

First, press the push lever against the wood; next, pull the trigger to drive the nail.  
Follow the same sequence to continue driving nails.  
After nailing once, nailing will not be possible again until the trigger is released and pressed again.
- CONTACT ACTUATION MECHANISM:

CONTACT ACTUATION can follow two different sequences, depending on your use.  
To drive several nails:
  1. Pull the trigger.
  2. Press the push lever against the wood to drive the nail.
  3. If the trigger is held back, a nail will be driven each time the push lever is pressed against the wood.

To drive a single nail:

1. Press the push lever against the wood.
2. Pull the trigger to drive the nail.
3. Remove your finger from the trigger and remove the nailer from the wood.

[Dry-fire lockout mechanism]

The NT1865DBAL, NT1865DBSL employs a preventive mechanism for unloaded operation.

The NT1865DBAL, NT1865DBSL enters a state where the push lever cannot be pushed up. This takes place when the magazine is not loaded with nails or when the remaining number of nails becomes less than 6 or 9.

### CAUTION

Use caution not to throw the push lever tip onto wood when the push lever cannot be pushed up.

#### 1. Nailing procedures

This Nailer is equipped with the push lever and does not operate unless the push lever is depressed.

There are two methods of operation to drive nails with this Nailer.

They are:

1. Intermittent operation (Trigger fire):
2. Continuous operation (Push lever fire):

### NOTE

New Zealand models of NT1865DBAL and NT1865DBSL specifications are only equipped for the intermittent operation (trigger fire) method. These New Zealand models cannot be switched to the continuous operation (push lever fire) method.

- (1) Intermittent operation (Trigger fire)  
Use the FULL SEQUENTIAL ACTUATION MECHANISM setting. (See Fig. 17)

### WARNING

- For intermittent operation, Set the nailing operation switch to FULL SEQUENTIAL ACTUATION MECHANISM (Nailing operation indicator is light in blue.) (i.e. Set to SINGLE ACTUATION MECHANISM.)
- To avoid double firing or accidental firing due to recoil.
  - 1) Set to FULL SEQUENTIAL ACTUATION MECHANISM.
  - 2) Pull the trigger rapidly and firmly.
- ① Set the nailing operation switch to FULL SEQUENTIAL ACTUATION MECHANISM (Nailing operation indicator is light in blue.)  
(to set to FULL SEQUENTIAL ACTUATION MECHANISM.)  
(Set the switching device to the nailing operation indicator light in blue mode completely as shown in the Fig. 17. Otherwise, it will be set to CONTACT ACTUATION MECHANISM.)
- ② Position the nail outlet on the workpiece with finger off the trigger.
- ③ Depress the push lever firmly until it is completely depressed.
- ④ Pull the trigger to drive a nail.
- ⑤ Remove finger from the trigger and lift the tool off the wood surface completely.

To continue nailing in a separate location, move the nailer along the wood, repeating steps ② - ⑤ as required.

### NOTE

Operations ③ and ④ should be done within 2 seconds of each other. If more than 2 seconds pass after ③, the Nailer will not work properly. If this happens, retry from ③.

- (2) Continuous operation (Push lever fire)  
Using CONTACT ACTUATION MECHANISM (See Fig. 18)

### WARNING

To avoid double firing or accidental firing due to recoil.

- 1) Do not press the nailer against the wood with excessive force.
- 2) Separate the nailer from the wood as it recoils after nailing.

- ① Set the nailing operation switch to CONTACT ACTUATION MECHANISM (Nailing operation indicator is blink in blue.)  
(to set to CONTACT ACTUATION MECHANISM).  
(Set the switching device to the nailing operation indicator blink in blue completely as shown in the Fig. 18. Otherwise, it will not operate properly.)

- ② Pull the trigger with the Nailer off the workpiece.
- ③ Depress the push lever against the workpiece to drive a nail.

- ④ Move the Nailer along the workpiece with a bouncing motion.

Each depression of the push lever will drive a nail.

As soon as the desired number of nails have been driven, remove finger from the trigger.

#### NOTE

Operations ② and ③ should be done within 2 seconds of each other. If more than 2 seconds pass after ②, the Nailer will not work properly. If this happens, retry from ②.

#### WARNING

- Keep your finger off the trigger except during nailing operation, because serious injury could result if the push lever accidentally contacts you or others in work area.
- Keep hands and body away from the discharge area. This HiKOKI nailer may bounce from the recoil of driving a nail and unwanted subsequent nail may be driven, possibly causing injury.

#### NOTE

- If all warnings and instructions are followed, safe operation is possible with all two systems: FULL SEQUENTIAL ACTUATION MECHANISM, CONTACT ACTUATION MECHANISM.

- Always handle nails and package carefully. If nails are dropped, collating bond may be broken, which will cause mis-feeding and jamming.

- After nailing:

- 1) remove battery from the Nailer;
- 2) remove all nails from the Nailer;

#### 2. Adjusting the nailing depth

To assure that each nail penetrates to the same depth, be sure that the Nailer is always held firmly against the workpiece.

If nails are driven too deep or shallow into the workpiece, adjust the nailing in the following order.

- ① Remove the battery from the Nailer.
- ② If nails are driven too deep, turn the adjuster to the shallow side. (See Fig. 19)

Adjustments are in half-turn increments.

If nails are driven too shallow, turn the adjuster to the deep side. (See Fig. 20)

- ③ Stop turning the adjuster when a suitable position is reached for a nailing test.

- ④ Connect the battery to the Nailer.

ALWAYS WEAR SAFETY GLASSES.

#### WARNING

Safety glasses should not be inferior to the specification set in AS/NZS 1337 Eye protectors for industrial applications.

Perform a nailing test.

- ⑤ Remove the battery from the Nailer.

- ⑥ Choose a suitable position for adjuster.

#### 3. Using the hook (See Fig. 21, 22, 23)

#### WARNING

When using the hook, turn off the power switch (green light "OFF"). Pay sufficient attention so that the main equipment does not fall.

If the tool falls, there is a risk of accident.

Hook can be installed on the left or right side.

- ① Remove the battery, then remove all remaining nails from the magazine.

- ② Securely hold the main unit and remove the screw using a screwdriver. (See Fig. 21)

- ③ Remove the hook and hook plate. (See Fig. 22)

- ④ Install the hook on the other side and securely fasten with screw. (See Fig. 23)

#### NOTE

Hook can be used as a hanger.

#### 4. Using the nose cap (See Fig. 24, 25)

#### WARNING

When attaching or detaching the nose cap, be sure to remove your finger from the trigger and remove all remaining fasteners and the battery from the nailer.

If you like to protect the surface of workpiece against scratches or markings made by the push lever, attach the accessory nose cap to the push lever.

- ① Remove all remaining fasteners and battery from nailer.

- ② Put the nose cap to the toe of the push lever.

- ③ The nose cap is marked to indicate the exit point of the nail, making alignment easier.

- ④ When not using the nose cap, secure in the storage compartment located on the reverse side of the magazine.

#### NOTE

The nose cap may reduce nailing depth due to its thickness. Re-adjustment of nailing depth is required.

#### 5. Clearing a jam

If nails are jammed in firing head, remove it, and adjust the nailing in the following order.

#### CAUTION

Remove the battery from the Nailer.

- ① Remove the battery from the Nailer.

- ② Remove all nails.

- ③ Release the Lock lever and open guide plate. (See Fig. 26)

- ④ Remove the jammed nail with a slotted-head screwdriver. (See Fig. 27)

#### CAUTION

- NEVER hit the driver blade.

- NEVER point the tool at yourself or another person, to avoid risk of injury by mis-firing.

Even if the battery is removed from the nailer, there is still energy of compressed air remaining inside.

- ⑤ Close guide plate and latch.

#### NOTE

In case of frequent jam, contact a HiKOKI authorized service center.

## MAINTENANCE AND INSPECTION

#### CAUTION

Be sure to remove all remaining fasteners and battery from the nailer before maintenance and inspection.

#### 1. Inspecting the magazine

- ① Remove battery from the Nailer.

- ② Clean the magazine. Remove dust and wooden chips which may have accumulated in the magazine.

#### CAUTION

Check that the nail feeder slides smoothly by pulling it with finger.

If not smooth, nails can be driven at an irregular angle and hurt someone.

#### 2. Inspecting the mounting screws

Regularly inspect all mounting screws and ensure that they are properly tightened. Should any of the screws be loose, retighten them immediately. Failure to do so could result in serious hazard.

#### 3. Maintenance of the motor

The motor unit winding is the very "heart" of the power tool. Exercise due care to ensure the winding does not become damaged and/or wet with oil or water.

#### 4. Cleaning on the outside

When the power tool is stained, wipe with a soft dry cloth or a cloth moistened with soapy water. Do not use chloric solvents, gasoline or paint thinner, for they melt plastics.

## 5. Storage

Store the power tool in a place in which the temperature is less than 40°C and out of reach of children.

### NOTE

Storing lithium-ion batteries.

Make sure the lithium-ion batteries have been fully charged before storing them.

Prolonged storage (3 months or more) of batteries with a low charge may result in performance deterioration, significantly reducing battery usage time or rendering the batteries incapable of holding a charge.

However, significantly reduced battery usage time may be recovered by repeatedly charging and using the batteries two to five times.

If the battery usage time is extremely short despite repeated charging and use, consider the batteries dead and purchase new batteries.

## CAUTION

In the operation and maintenance of power tools, the safety regulations and standards prescribed in each country must be observed.

### Important notice on the batteries for the HiKOKI cordless power tools

Please always use one of our designated genuine batteries. We cannot guarantee the safety and performance of our cordless power tool when used with batteries other than these designated by us, or when the battery is disassembled and modified (such as disassembly and replacement of cells or other internal parts).

### NOTE

Due to HiKOKI's continuing program of research and development, the specifications herein are subject to change without prior notice.

## Maintenance chart

ACTION	WHY	HOW
Clean magazine and feeder mechanism.	Prevent a jam.	Blow clean daily.
Keep push lever working properly.	Promote operator safety and efficient Nailer operation.	Blow clean daily.







## TROUBLESHOOTING

Use the inspections in the table below if the tool does not operate normally. If this does not remedy the problem, consult your dealer or the HiKOKI Authorized Service Center.

PROBLEM	CHECK METHOD	CORRECTION
Power switch doesn't turn on. Turn on once, but turn off automatically.	Low battery charge.	Charge the battery.
	Damaged internal electronics.	Contact HiKOKI for replacement.
	Push lever and/or trigger is ON state ?	Keep push lever and trigger in OFF state.
	Keep no operation over 30 minutes ? (Auto-power off function)	Push and hold power switch more than 1 second to switch "ON"
Nailer doesn't operate (Power switch ON).	Nailer not enough pressed against workpiece.	Hold nailer firmly and press to the workpiece completely.
	Trigger not enough pulled.	Pull the trigger firmly.
	More than 2 seconds pass from push lever ON to trigger ON (or trigger ON to push lever ON).	Make sure that less than 2 seconds pass between push lever ON and trigger ON (or between trigger ON and push lever ON).
	Preventive mechanism activated. (No nails, or too few fasteners remaining) (NT1865DBAL / NT1865DBSL only)	Reload the nails into magazine.
	Switch lock lever (Trigger lock function) is "ON" position.	Set Switch lock lever to "OFF" position. (Refer to <b>Fig. 8</b> )
	Machine is too cold (below -5°C) or too hot. (LED light blinks at regular intervals, and power switch goes off after 10 seconds.) (Refer to page 11)	Allow the nailer to cool or warm-up thoroughly in adequate condition.
	Damaged internal electronics.	Contact HiKOKI for replacement.

PROBLEM	CHECK METHOD	CORRECTION
Nailer operates, but no nail is driven.	Magazine is dirty.	Blow and wipe clean the magazine.
	Check for a jam.	Clear a jam (refer to <b>Fig. 26, 27</b> ).
	Driver blade worn or damaged?	Contact HiKOKI for replacement.
	Ribbon spring weakened or damaged?	Replace ribbon spring.
	Nail feeder damaged?	Replace nail feeder.
	Check for proper nails.	Use only recommended nails.
Weak drive. Slow to cycle.	Check position of nailing depth adjustment adjuster.	Readjust according to <b>Fig. 19, 20</b> .
	Driver blade worn?	Contact HiKOKI for replacement.
	Compressed air pressure has become low.	Contact HiKOKI for replacement.
	Damaged internal electronics.	Contact HiKOKI for replacement.
Drives too deep.	Check position of nailing depth adjustment adjuster.	Readjust according to <b>Fig. 19, 20</b> .
Skipping nails. Intermittent feed.	Check for proper nails.	Use only recommended nails.
	Nail feeder damaged?	Replace nail feeder.
	Ribbon spring weakened or damaged?	Replace ribbon spring.
	Driver blade worn or damaged?	Contact HiKOKI for replacement.
Nails jam. Driven nail is bent.	Check for proper nails.	Use only recommended nails.
	Driver blade worn or damaged?	Contact HiKOKI for replacement.
The charge indicator lamp is rapidly flickers purple, and battery charging doesn't begin.	The battery is not inserted all the way.	Insert the battery firmly.
	There is foreign matter in the battery terminal or where the battery is attached.	Remove the foreign matter.
The charge indicator lamp blinks red, and battery charging doesn't begin.	The battery is not inserted all the way.	Insert the battery firmly.
	The battery is overheated.	If left alone, the battery will automatically begin charging if its temperature decreases, but this may reduce battery life. It is recommended that the battery be cooled in a well-ventilated location away from direct sunlight before charging it.
Battery usage time is short even though the battery is fully charged.	The battery's life is depleted.	Replace the battery with a new one.
The battery takes a long time to charge.	The temperature of the battery, the charger, or the surrounding environment is extremely low.	Charge the battery indoors or in another warmer environment.
	The charger's vents are blocked, causing its internal components to overheat.	Avoid blocking the vents.
	The cooling fan is not running.	Contact a HiKOKI Authorized Service Center for repairs.
Charging of a USB device pauses midway.	The charger was plugged into an electrical socket while the USB device was being charged using the battery as the power source.	This is not a malfunction. The charger pauses USB charging for about 5 seconds when it is differentiating between power sources.
	A battery was inserted into the charger while the USB device was being charged using a power socket as the power source.	
Charging of the USB device pauses midway when the battery and the USB device are being charged at the same time.	The battery has become fully charged.	This is not a malfunction. The charger pauses USB charging for about 5 seconds while it checks whether the battery has successfully completed charging.
Charging of the USB device doesn't start when the battery and the USB device are being charged at the same time.	The remaining battery capacity is extremely low.	This is not a malfunction. When the battery capacity reaches a certain level, USB charging automatically begins.

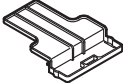
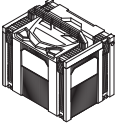
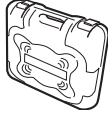

	NT1865DBAL		NT1865DBSL		NT1850DBSL	
		(NN)		(NN)		(NN)
	1	1	1	1	1	1
 /  BSL1830C / BSL1860	2	—	2	—	2	—
 UC18YSL3	1	—	1	—	1	—
	1	1	1	1	—	—
	—	—	—	—	2	2
	1	—	1	—	1	—
 / 	1	—	1	—	1	—

1

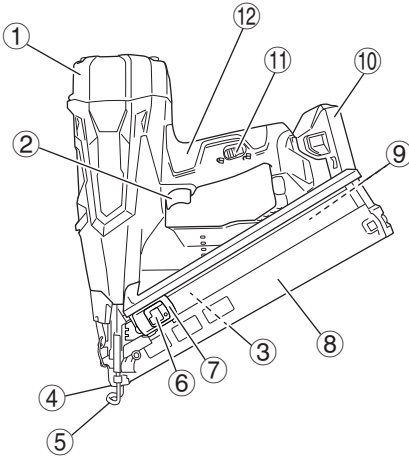

<NT1865DBAL>

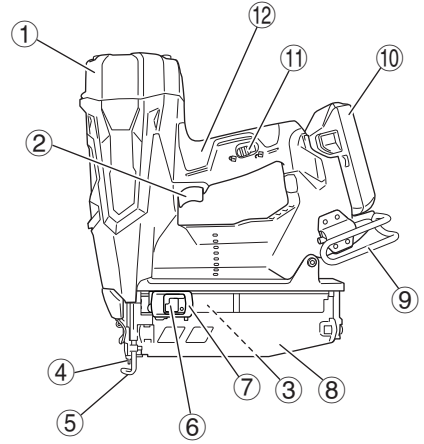

<NT1865DBSL>

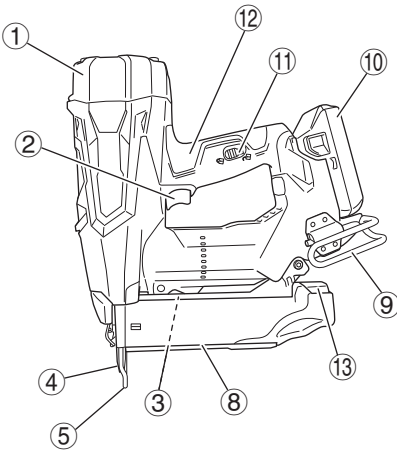

<NT1850DBSL>

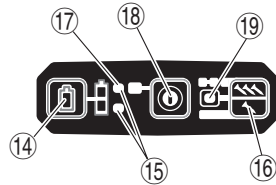

New Zealand models of NT1865DBAL and NT1865DBSL

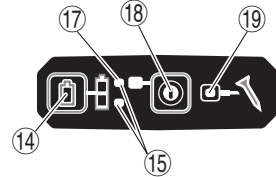

2

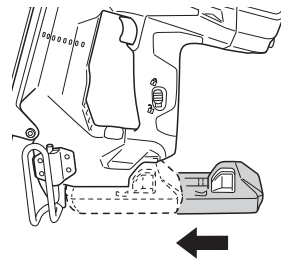
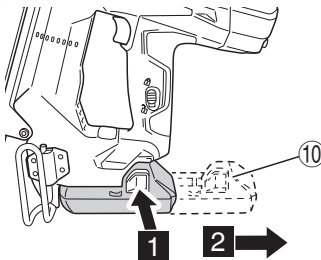

3

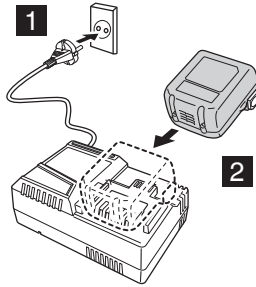

<UC18YSL3>

4

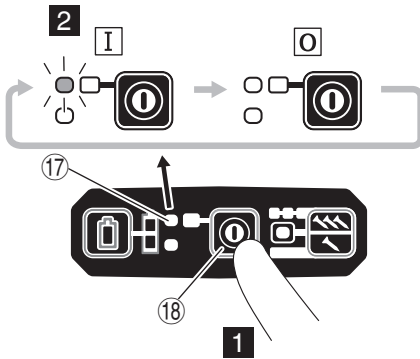

5

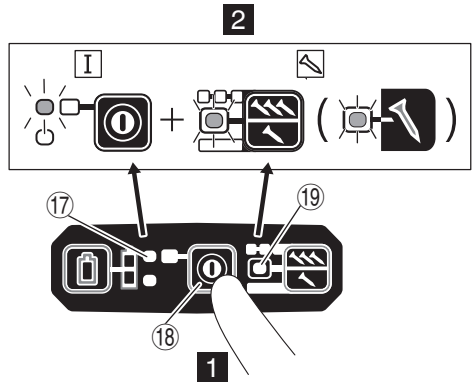

6

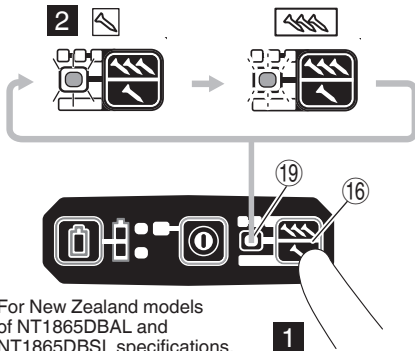

For New Zealand models  
of NT1865DBAL and  
NT1865DBSL specifications,  
nailing operation mode cannot  
be switched.

7

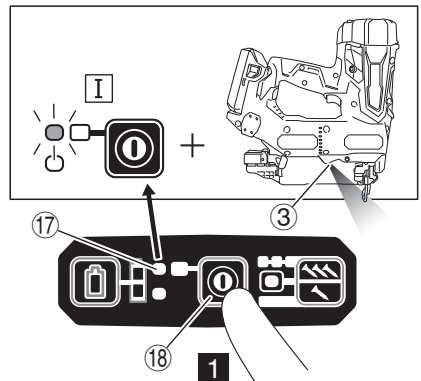

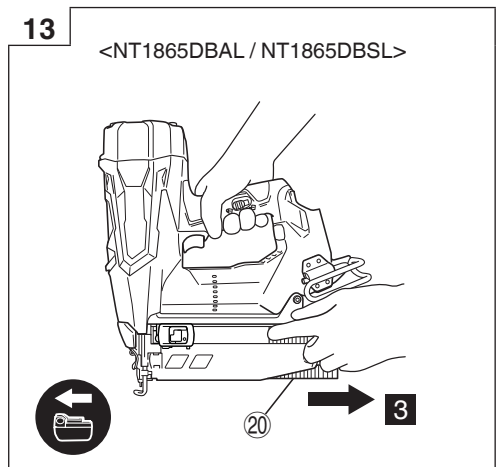
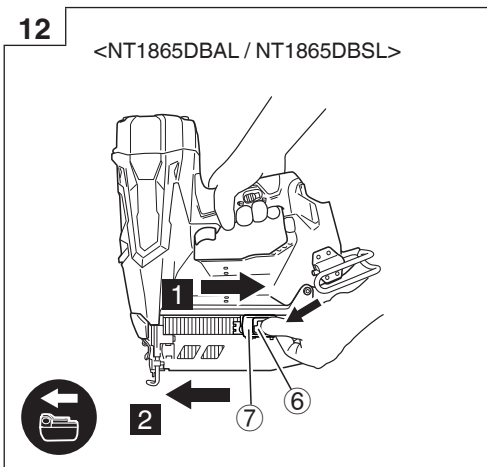
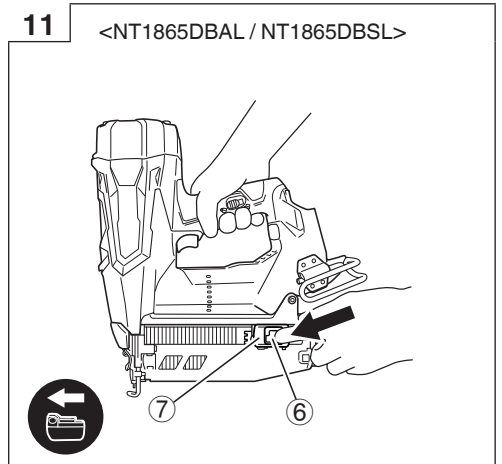
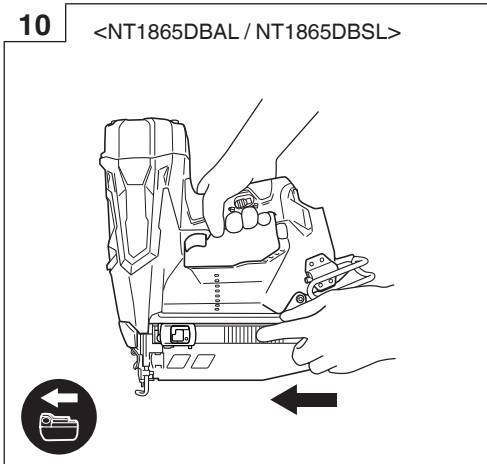
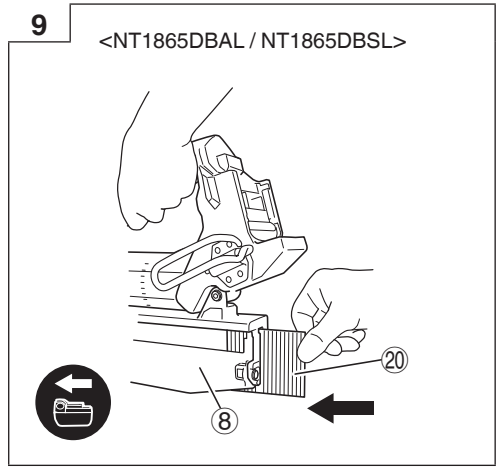
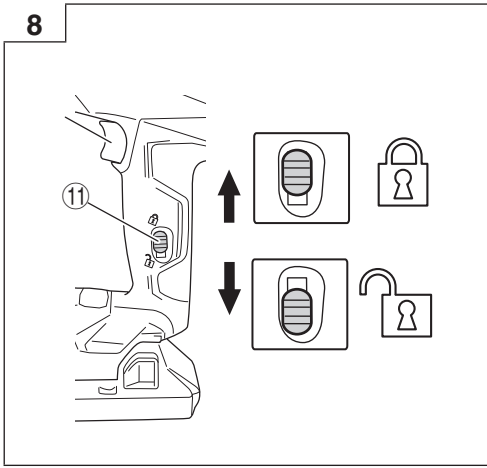

14

<NT1850DBSL>

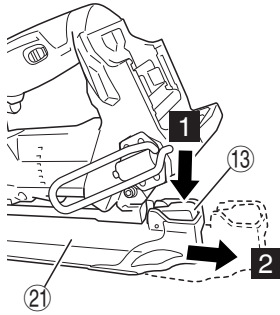

15

<NT1850DBSL>

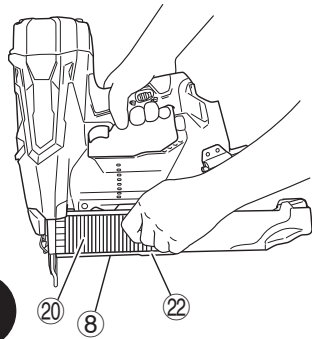

16

<NT1850DBSL>

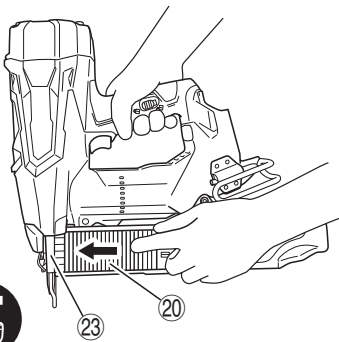

17

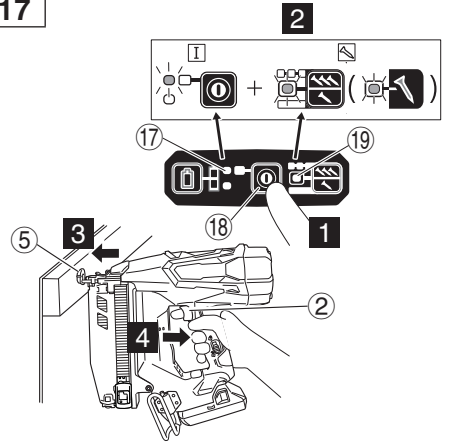

18

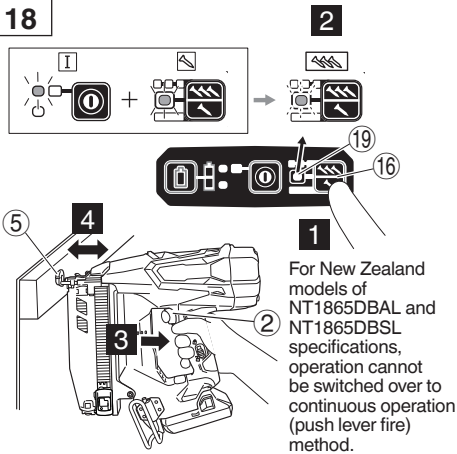

19

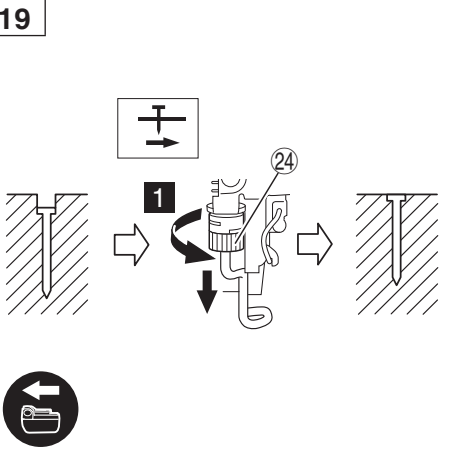

20

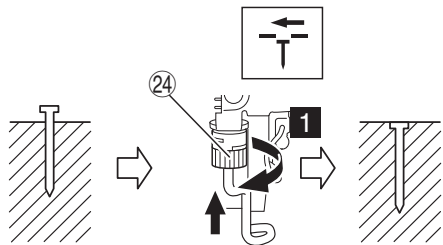

21

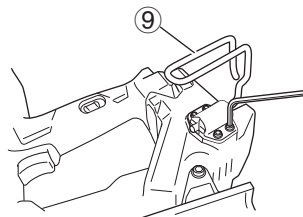

22

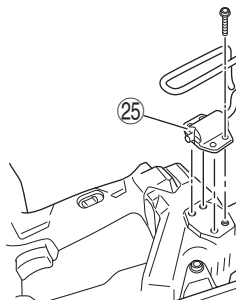

23

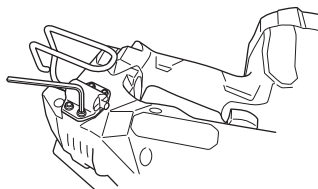

24

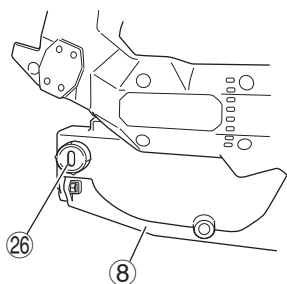
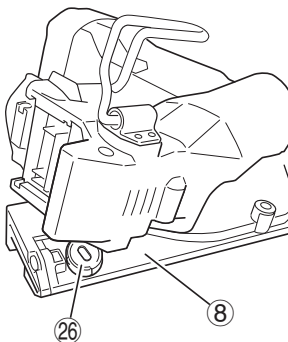
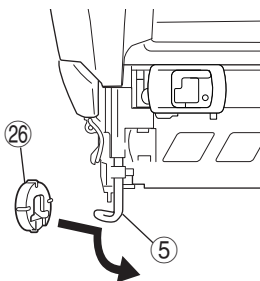

<NT1865DBAL>

<NT1865DBSL>

25

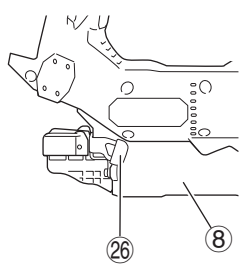
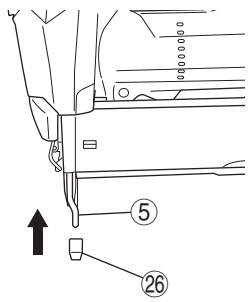

<NT1850DBSL>

26

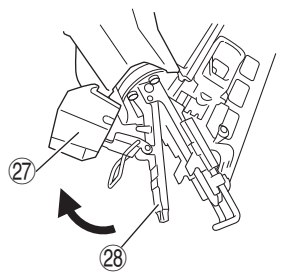

27

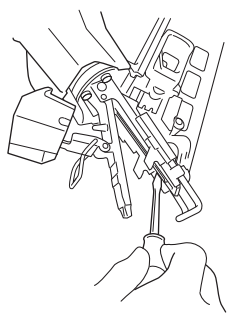

28

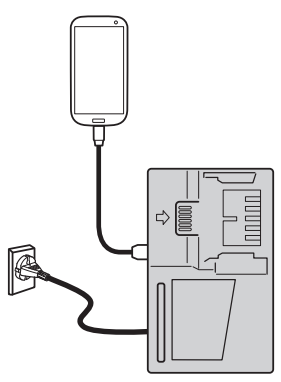

a

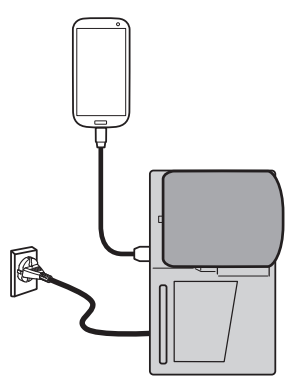

b

29

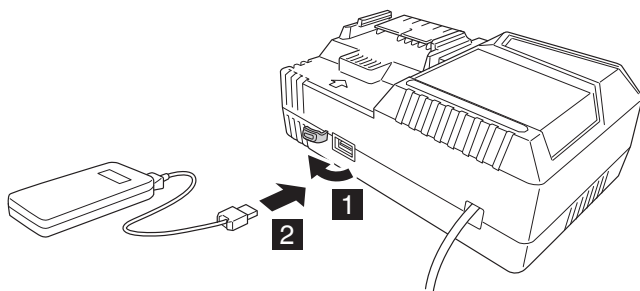

30

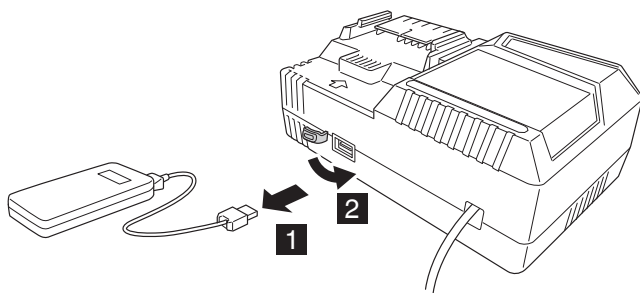



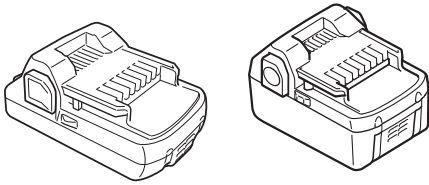

18V (Li-ion)

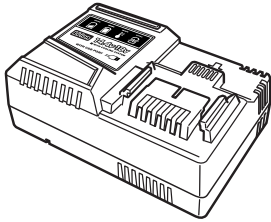

UC18YSL3 (14.4V - 18V)

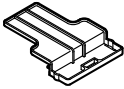

329897

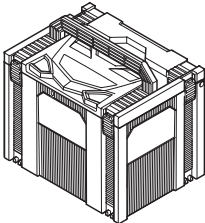

337528

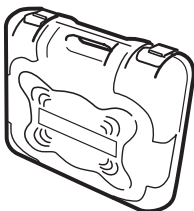

371896

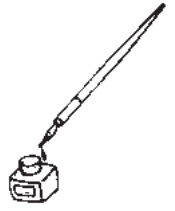

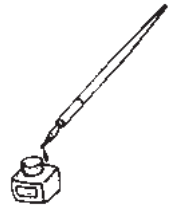

# Koki Holdings Co., Ltd.

Shinagawa Intercity Tower A, 15-1, Konan 2-chome,  
Minato-ku, Tokyo, Japan