

HIKOKI

CV 14DBL • CV 18DBL

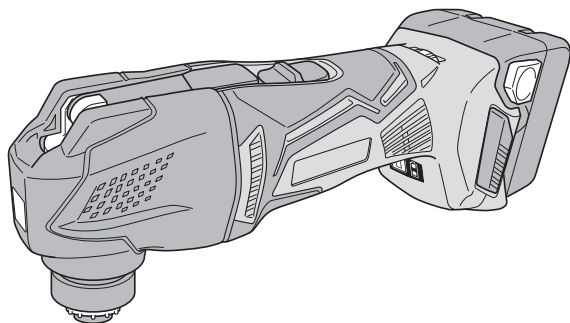

CV14DBL



Handling instructions

GENERAL POWER TOOL SAFETY WARNINGS

⚠ WARNING

Read all safety warnings and all instructions.

Failure to follow the warnings and instructions may result in electric shock, fire and/or serious injury.

Save all warnings and instructions for future reference.

The term "power tool" in the warnings refers to your mains-operated (corded) power tool or battery-operated (cordless) power tool.

1) Work area safety

- a) **Keep work area clean and well lit.**
Cluttered or dark areas invite accidents.
- b) **Do not operate power tools in explosive atmospheres, such as in the presence of flammable liquids, gases or dust.**
Power tools create sparks which may ignite the dust or fumes.
- c) **Keep children and bystanders away while operating a power tool.**
Distractions can cause you to lose control.

2) Electrical safety

- a) **Power tool plugs must match the outlet. Never modify the plug in any way. Do not use any adapter plugs with earthed (grounded) power tools.**
Unmodified plugs and matching outlets will reduce risk of electric shock.
- b) **Avoid body contact with earthed or grounded surfaces, such as pipes, radiators, ranges and refrigerators.**
There is an increased risk of electric shock if your body is earthed or grounded.
- c) **Do not expose power tools to rain or wet conditions.**
Water entering a power tool will increase the risk of electric shock.
- d) **Do not abuse the cord. Never use the cord for carrying, pulling or unplugging the power tool. Keep cord away from heat, oil, sharp edges or moving parts.**
Damaged or entangled cords increase the risk of electric shock.
- e) **When operating a power tool outdoors, use an extension cord suitable for outdoor use.**
Use of a cord suitable for outdoor use reduces the risk of electric shock.
- f) **If operating a power tool in a damp location is unavoidable, use a residual current device (RCD) protected supply.**
Use of an RCD reduces the risk of electric shock.

3) Personal safety

- a) **Stay alert, watch what you are doing and use common sense when operating a power tool. Do not use a power tool while you are tired or under the influence of drugs, alcohol or medication.**
A moment of inattention while operating power tools may result in serious personal injury.
- b) **Use personal protective equipment. Always wear eye protection.**
Protective equipment such as dust mask, non-skid safety shoes, hard hat, or hearing protection used for appropriate conditions will reduce personal injuries.
- c) **Prevent unintentional starting. Ensure the switch is in the off position before connecting to power source and/or battery pack, picking up or carrying the tool.**

Carrying power tools with your finger on the switch or energising power tools that have the switch on invites accidents.

- d) **Remove any adjusting key or wrench before turning the power tool on.**
A wrench or a key left attached to a rotating part of the power tool may result in personal injury.
 - e) **Do not overreach. Keep proper footing and balance at all times.**
This enables better control of the power tool in unexpected situations.
 - f) **Dress properly. Do not wear loose clothing or jewellery. Keep your hair, clothing and gloves away from moving parts.**
Loose clothes, jewellery or long hair can be caught in moving parts.
 - g) **If devices are provided for the connection of dust extraction and collection facilities, ensure these are connected and properly used.**
Use of dust collection can reduce dust-related hazards.
- ### **4) Power tool use and care**
- a) **Do not force the power tool. Use the correct power tool for your application.**
The correct power tool will do the job better and safer at the rate for which it was designed.
 - b) **Do not use the power tool if the switch does not turn it on and off.**
Any power tool that cannot be controlled with the switch is dangerous and must be repaired.
 - c) **Disconnect the plug from the power source and/or the battery pack from the power tool before making any adjustments, changing accessories, or storing power tools.**
Such preventive safety measures reduce the risk of starting the power tool accidentally.
 - d) **Store idle power tools out of the reach of children and do not allow persons unfamiliar with the power tool or these instructions to operate the power tool.**
Power tools are dangerous in the hands of untrained users.
 - e) **Maintain power tools. Check for misalignment or binding of moving parts, breakage of parts and any other condition that may affect the power tool's operation. If damaged, have the power tool repaired before use.**
Many accidents are caused by poorly maintained power tools.
 - f) **Keep cutting tools sharp and clean.**
Properly maintained cutting tools with sharp cutting edges are less likely to bind and are easier to control.
 - g) **Use the power tool, accessories and tool bits etc. in accordance with these instructions, taking into account the working conditions and the work to be performed.**
Use of the power tool for operations different from those intended could result in a hazardous situation.
- ### **5) Battery tool use and care**
- a) **Recharge only with the charger specified by the manufacturer.**
A charger that is suitable for one type of battery pack may create a risk of fire when used with another battery pack.
 - b) **Use power tools only with specifically designated battery packs.**
Use of any other battery packs may create a risk of injury and fire.

- c) **When battery pack is not in use, keep it away from other metal objects, like paper clips, coins, keys, nails, screws or other small metal objects, that can make a connection from one terminal to another.**

Shorting the battery terminals together may cause burns or a fire.

- d) **Under abusive conditions, liquid may be ejected from the battery; avoid contact. If contact accidentally occurs, flush with water. If liquid contacts eyes, additionally seek medical help.**

Liquid ejected from the battery may cause irritation or burns.

6) **Service**

- a) **Have your power tool serviced by a qualified repair person using only identical replacement parts.**

This will ensure that the safety of the power tool is maintained.

PRECAUTION

Keep children and infirm persons away. When not in use, tools should be stored out of reach of children and infirm persons.

CORDLESS MULTI TOOL SAFETY WARNINGS

1. **Hold power tool by insulated gripping surfaces, when performing an operation where the cutting accessory may contact hidden wiring.**
Cutting accessory contacting a "live" wire may make exposed metal parts of the power tool "live" and could give the operator an electric shock.

ADDITIONAL SAFETY WARNINGS

- Always hold the tool firmly with one hand on housing (Fig. 10). Do not touch the metal part.
- Make sure that the area to be cut is absolutely free of any hidden obstructions including electrical wiring, water, or gas pipes. Cutting into the aforementioned may result in electric shock or short circuit, gas leak or other hazards that can cause serious accidents or injuries.
- Make sure to securely hold the tool during operation. Failure to do so can result in accidents or injuries.
- Secure the workpiece. A workpiece clamped with clamping devices or in a vice is held more secure than by hand.
- Setting up and checking the work environment. Check if the work environment is suitable by following the precaution.
- Dust particles such as silica or asbestos are hazardous to your health. When working with materials containing these components, take appropriate dust-proofing measures.
- Working with metal can cause sparks. Make sure there are no flammable and combustible materials in the vicinity and that they are stored in a safe location.
- Do not allow foreign matter to enter the hole for connecting the rechargeable battery.
- Never disassemble the rechargeable battery and charger.
- Never short-circuit the rechargeable battery. Shortcircuiting the battery will cause a great electric current and overheat. It results in burn or damage to the battery.
- Do not dispose of the battery in fire. If the battery is burnt, it may explode.

- Bring the battery to the shop from which it was purchased as soon as the post-charging battery life becomes too short for practical use. Do not dispose of the exhausted battery.
- Do not insert object into the air ventilation slots of the charger. Inserting metal objects or inflammables into the charger air ventilation slots will result in electrical shock hazard or damaged charger.
- After use for continuous cutting or grinding works, rest the unit for 15 minutes or so when replacing the battery. The temperature of the motor, switch, etc., will rise if the work is started again immediately after battery replacement, eventually resulting in burnout.
- The motor may stop in the event the tool is overloaded. In this should occur, release the tool's switch and eliminate the cause of the overload.
- The use of the battery in a cold condition (below 0 degree Centigrade) can sometimes result in the weakened tightening torque and reduced amount of work. This, however, is a temporary phenomenon, and returns to normal when the battery warms up.
- Do not look directly into the light. Such actions could result in eye injury.
- Do not touch the application tool, its attachment area or other metal surfaces immediately after use as they will be hot. Doing so may result in burns or injury. The metal is hot and can easily burn your skin.
- Make sure that there is no one below when operating the tool in high locations. Dropping the tool or materials may result in accident or injury.
- Never apply any unreasonable force to the application tool when working. Doing so may break the application tool or damage the motor.
- Do not leave the tool running unattended on the floor, table or other locations. Doing so may result in injury.
- When attaching application tools, be careful not to get your fingers or other extremities caught in the lever.
- If the application tool seems to be loose or uneven after attaching it to the unit, follow the instructions in Fig. 5 and re-attach the tool. Operating the unit with a loose or uneven application tool may result in injury.
- When switching on the tool, make sure the application tool is not in contact with any processing materials. Failure to do so may result in injury.
- For cutting efficiency, switch the mode of the application tool according to task conditions and materials to be cut.
- After use, be sure not to place the tool near chips or sawdust before it comes to a full stop as the tool may suck in those particles.
- Do not polish wood with sanding paper used for metal polishing.
- Do not use worn or clogged sanding paper.

CAUTION ON LITHIUM-ION BATTERY

To extend the lifetime, the lithium-ion battery equips with the protection function to stop the output.

In the cases of 1 to 3 described below, when using this product, even if you are pulling the switch, the motor may stop. This is not the trouble but the result of protection function.

- When the battery power remaining runs out, the motor stops.
In such a case, charge it up immediately.
 - If the tool is overloaded, the motor may stop. In this case, release the switch of tool and eliminate causes of overloading. After that, you can use it again.
 - If the battery is overheated under overload work, the battery power may stop.
In this case, stop using the battery and let the battery cool. After that, you can use it again.
- Furthermore, please heed the following warning and caution.

WARNING

In order to prevent any battery leakage, heat generation, smoke emission, explosion and ignition beforehand, please be sure to heed the following precautions.

1. Make sure that swarf and dust do not collect on the battery.
- During work make sure that swarf and dust do not fall on the battery.
- Make sure that any swarf and dust falling on the power tool during work do not collect on the battery.
- Do not store an unused battery in a location exposed to swarf and dust.
- Before storing a battery, remove any swarf and dust that may adhere to it and do not store it together with metal parts (screws, nails, etc.).
2. Do not pierce battery with a sharp object such as a nail, strike with a hammer, step on, throw or subject the battery to severe physical shock.
3. Do not use an apparently damaged or deformed battery.
4. Do not use the battery in reverse polarity.
5. Do not connect directly to an electrical outlets or car cigarette lighter sockets.
6. Do not use the battery for a purpose other than those specified.
7. If the battery charging fails to complete even when a specified recharging time has elapsed, immediately stop further recharging.
8. Do not put or subject the battery to high temperatures or high pressure such as into a microwave oven, dryer, or high pressure container.
9. Keep away from fire immediately when leakage or foul odor are detected.
10. Do not use in a location where strong static electricity generates.
11. If there is battery leakage, foul odor, heat generated, discolored or deformed, or in any way appears abnormal during use, recharging or storage, immediately remove it from the equipment or battery charger, and stop use.

CAUTION

1. If liquid leaking from the battery gets into your eyes, do not rub your eyes and wash them well with fresh clean water such as tap water and contact a doctor immediately.
If left untreated, the liquid may cause eye-problems.
2. If liquid leaks onto your skin or clothes, wash well with clean water such as tap water immediately.
There is a possibility that this can cause skin irritation.
3. If you find rust, foul odor, overheating, discolor, deformation, and/or other irregularities when using the battery for the first time, do not use and return it to your supplier or vendor.

WARNING

If a conductive foreign matter enters in the terminal of lithium ion battery, the battery may be shorted, causing fire. When storing the lithium ion battery, obey surely the rules of following contents.

- Do not place conductive debris, nail and wires such as iron wire and copper wire in the storage case.
- To prevent shorting from occurring, load the battery in the tool or insert securely the battery cover for storing until the ventilator is not seen.

REGARDING LITHIUM-ION BATTERY TRANSPORTATION

When transporting a lithium-ion battery, please observe the following precautions.

WARNING

Notify the transporting company that a package contains a lithium-ion battery, inform the company of its power output and follow the instructions of the transportation company when arranging transport.

- Lithium-ion batteries that exceed a power output of 100Wh are considered to be in the freight classification of Dangerous Goods and will require special application procedures.
- For transportation abroad, you must comply with international law and the rules and regulations of the destination country.

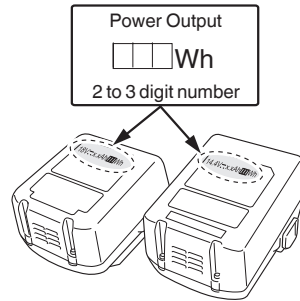

USB DEVICE CONNECTION PRECAUTIONS (ONLY WITH UC18YSL3 CHARGER)

When an unexpected problem occurs, the data in a USB device connected to this product may be corrupted or lost. Always make sure to back up any data contained in the USB device prior to use with this product.

Please be aware that our company accepts absolutely no responsibility for any data stored in a USB device that is corrupted or lost, nor for any damage that may occur to a connected device.

WARNING

- Prior to use, check the connecting USB cable for any defect or damage.
Using a defective or damaged USB cable can cause smoke emission or ignition.
- When the product is not being used, cover the USB port with the rubber cover.
Buildup of dust etc. in the USB port can cause smoke emission or ignition.





















NOTE

- There may be an occasional pause during USB recharging.
- When a USB device is not being charged, remove the USB device from the charger.
Failure to do so may not only reduce the battery life of a USB device, but may also result in unexpected accidents.
- It may not be possible to charge some USB devices, depending on the type of device.

SYMBOLS

WARNING

The following show symbols used for the machine. Be sure that you understand their meaning before use.

	CV14DBL / CV18DBL: Cordless Multi Tool
	Read all safety warnings and all instructions.
V	Rated voltage
n_0	No-load speed
/min	Oscillation per minute
	Oscillation angle, Total (left / right)
	Weight
	Switching ON
	Switching OFF
	Disconnect the battery
	Lock
	Unlock
	Pad
	Sanding paper
	Blade
	Cutsaw
	Accessory case
	Battery capacity
	Remaining battery indicator switch
	The battery remaining power is nearly empty. Recharge the battery soonest possible
	The battery remaining power is a half.
	The battery remaining power is enough.
	Prohibited action

APPLICATIONS

- Flush cutting and pocket cutting of various materials
- Peeling of tiles, caulking, etc.
- Polishing wood materials, etc.

SPECIFICATIONS

The specifications of this machine are listed in the Table on page 9.

NOTE

Due to HiKOKI's continuing program of research and development, the specifications herein are subject to change without prior notice.

CHARGING

Before using the power tool, charge the battery as follows.

1. **Connect the charger's power cord to the receptacle.** (Fig. 2)

<UC18YFSL>

When connecting the plug of the charger to a receptacle, the pilot lamp will blink in red (At 1-second intervals).

<UC18YSL3>

When connecting the plug of the charger to a receptacle, the charge indicator lamp will blink in red (At 1-second intervals).

CAUTION

Do not use the electrical cord if damaged. Have it repaired immediately.

2. **Insert the battery into the charger.** (Fig. 2)

Firmly insert the battery into the charger.

3. **Charging**

<UC18YFSL>

When inserting a battery in the charger, the pilot lamp will light up continuously in red.

When the battery becomes fully recharged, the pilot lamp will blink in red (At 1-second intervals). (See **Table 1-a**)

- Pilot lamp indication

The indications of the pilot lamp will be as shown in **Table 1-a**, according to the condition of the charger or the rechargeable battery.

<UC18YSL3>

When inserting a battery in the charger, the charge indicator lamp will blink in blue.

When the battery becomes fully recharged, the charge indicator lamp will light up in green. (See **Table 1-b**)

- Charge indicator lamp indication

The indications of the charge indicator lamp will be as shown in **Table 1-b**, according to the condition of the charger or the rechargeable battery.

STANDARD ACCESSORIES

In addition to the main unit (1 unit), the package contains the accessories listed on page 9.

Standard accessories are subject to change without notice.

Table 1-a

Indications of the pilot lamp				
Pilot lamp (red)	Before charging	Blinks	Lights for 0.5 seconds. Does not light for 0.5 seconds. (off for 0.5 seconds)	/
	While charging	Lights	Lights continuously	
	Charging complete	Blinks	Lights for 0.5 seconds. Does not light for 0.5 seconds. (off for 0.5 seconds)	
	Overheat standby	Blinks	Lights for 1 second. Does not light for 0.5 seconds. (off for 0.5 seconds)	Battery overheated. Unable to charge. (Charging will commence when battery cools)
	Charging impossible	Flickers	Lights for 0.1 seconds. Does not light for 0.1 seconds. (off for 0.1 seconds)	Malfunction in the battery or the charger

NOTE: When standby for cooling battery, UC18YFSL cools the overheated battery by cooling fan.

Table 1-b

Indications of the charge indicator lamp				
Charge indicator lamp (red / blue / green / purple)	Before charging	Blinks (red)	Lights for 0.5 seconds. Does not light for 0.5 seconds. (off for 0.5 seconds)	Plugged into power source
	While charging	Blinks (blue)	Lights for 0.5 seconds. Does not light for 1 second. (off for 1 second)	Battery capacity at less than 50%
		Blinks (blue)	Lights for 1 second. Does not light for 0.5 seconds. (off for 0.5 seconds)	Battery capacity at less than 80%
		Lights (blue)	Lights continuously	Battery capacity at more than 80%
	Charging complete	Lights (green)	Lights continuously (Continuous buzzer sound: about 6 seconds)	/
	Overheat standby	Blinks (red)	Lights for 0.3 seconds. Does not light for 0.3 seconds. (off for 0.3 seconds)	Battery overheated. Unable to charge. (Charging will commence when battery cools)
	Charging impossible	Flickers (purple)	Lights for 0.1 seconds. Does not light for 0.1 seconds. (off for 0.1 seconds) (Intermittent buzzer sound: about 2 seconds)	Malfunction in the battery or the charger

NOTE: When standby for cooling battery, UC18YSL3 cools the overheated battery by cooling fan.

- Regarding the temperatures and charging time of the battery. The temperatures and charging time will become as shown in **Table 2**.

Table 2

Battery \ Charger		UC18YFSL	UC18YSL3
		Charging voltage	V
Weight	kg	0.5	0.6
Temperatures at which the battery can be recharged		0°C – 50°C	-10°C – 50°C
Charging time for battery capacity, approx. (At 20°C)			
1.5 Ah	min.	22	15
2.0 Ah	min.	30	20
2.5 Ah	min.	35	25
3.0 Ah	min.	45	20
4.0 Ah	min.	60	26
5.0 Ah	min.	75	32
6.0 Ah	min.	90	38
Number of battery cells		4 – 10	

NOTE

The recharging time may vary according to the ambient temperature and power source voltage.

CAUTION

When the battery charger has been continuously used, the battery charger will be heated, thus constituting the cause of the failures. Once the charging has been completed, give 15 minutes rest until the next charging.

4. Disconnect the charger's power cord from the receptacle.

5. Hold the charger firmly and pull out the battery.

NOTE

Be sure to pull out the battery from the charger after use, and then keep it.

CAUTION

- If the battery is charged while it is heated because it has been left for a long time in a location subject to direct sunlight or because the battery has just been used, the pilot lamp of UC18YFSL charger lights for 1 second, does not light for 0.5 seconds (off for 0.5 seconds), or the charge indicator lamp of UC18YSL3 charger lights for 0.3 seconds, does not light for 0.3 seconds (off for 0.3 seconds). In such a case, first let the battery cool, then start charging.
- When the pilot lamp or charge indicator lamp flickers (at 0.2-second intervals), check for and take out any foreign objects in the charger's battery connector. If there are no foreign objects, it is probable that the battery or charger is malfunctioning. Take it to your authorized Service Center.
- Since the built-in micro computer takes about 3 seconds to confirm that the battery being charged with charger is taken out, wait for a minimum of 3 seconds before reinserting it to continue charging. If the battery is reinserted within 3 seconds, the battery may not be properly charged.
- If the pilot lamp or charge indicator lamp does not blink in red (every second) even though the charger cord is connected to the power, it indicates that the protection circuit of the charger may be activated. Remove the cord from the power and then connect it again after 30 seconds or so. If this does not cause the pilot lamp or charge indicator lamp to blink in red (every second), please take the charger to the HIKOKI Authorized Service Center.

MOUNTING AND OPERATION

Action	Figure	Page
Removing and inserting the battery	1	10
Charging	2	10
Remaining battery indicator	3	10
How to use the LED light	4	10
Mounting the application tool	5	11
Switch Operation	6	12
Adjusting operating speed*1	7	12
Sawing	8	12
Sanding	9	12
Charging a USB device from an electrical outlet	11-a	13
Charging a USB device and battery from an electrical outlet	11-b	13
How to recharge USB device	12	13
When charging of USB device is completed	13	13
Selecting accessories*2	—	14

The tool is equipped with two modes: "Standard Mode" and "AUTO Mode".

(1) Standard Mode

You can change the vibration frequency between 6000 to 20000 /min by adjusting the dial from "1" to "5".

(2) AUTO Mode

Depending on the workload, AUTO Mode "A" will automatically change the vibration frequency to 15000 /min or 20000 /min. This has the effect of lowering vibration and noise prior to and during operation.

Adjust the dial for the mode and speed that best suits your task conditions and materials.

*1 Operating speed

Mode	Dial	Vibration Frequency
Standard Mode	1 – 5	6000 – 20000 /min
AUTO Mode	A	No load: 15000 /min With load: 20000 /min

With AUTO Mode, the vibration frequency may not reach 20000 /min or return to 15000 /min depending on variables such as the type of work or the attachment in use.

*2 Select accessories that are suited to a specific task.

For details contact HIKOKI Authorized Service Center.

MAINTENANCE AND INSPECTION

1. Inspecting the application tool

Continued use of a dull or damaged application tool will result in reduced cutting efficiency and may cause overloading of the motor. Replace the application tool with a new one as soon as excessive abrasion is noted.

2. Inspecting the mounting screws

Regularly inspect all mounting screws and ensure that they are properly tightened. Should any of the screws be loose, retighten them immediately. Failure to do so could result in serious hazard.

3. Maintenance of the motor

The motor unit winding is the very "heart" of the power tool. Exercise due care to ensure the winding does not become damaged and/or wet with oil or water.

4. Cleaning on the outside

When the power tool is stained, wipe with a soft dry cloth or a cloth moistened with soapy water. Do not use chloric solvents, gasoline or paint thinner, for they melt plastics.

5. Storage

Store the power tool in a place in which the temperature is less than 40°C and out of reach of children.

NOTE

Storing lithium-ion batteries.

Make sure the lithium-ion batteries have been fully charged before storing them.

Prolonged storage (3 months or more) of batteries with a low charge may result in performance deterioration, significantly reducing battery usage time or rendering the batteries incapable of holding a charge.

However, significantly reduced battery usage time may be recovered by repeatedly charging and using the batteries two to five times.

If the battery usage time is extremely short despite repeated charging and use, consider the batteries dead and purchase new batteries.

CAUTION



In the operation and maintenance of power tools, the safety regulations and standards prescribed in each country must be observed.





Important notice on the batteries for the HiKOKI cordless power tools

Please always use one of our designated genuine batteries. We cannot guarantee the safety and performance of our cordless power tool when used with batteries other than these designated by us, or when the battery is disassembled and modified (such as disassembly and replacement of cells or other internal parts).

NOTE

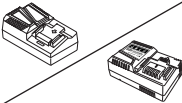
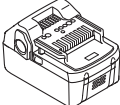
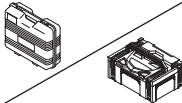
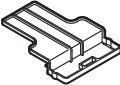
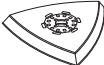
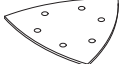
Due to HiKOKI's continuing program of research and development, the specifications herein are subject to change without prior notice.

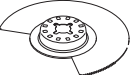
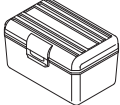
		CV14DBL	CV18DBL
V		14.4 V	18 V
n ₀	1 – 5	6000 – 20000 /min	6000 – 20000 /min
	A	15000 /min	15000 /min
		3.2° (1.6°)	3.2° (1.6°)
		1.6 kg (BSL1425)	1.7 kg (BSL1825)

	CV14DBL		CV18DBL	
		(NN)		(NN)
	1	–	1	–
	2	–	2	–
	1	–	1	–
	1	–	1	–
	1	0 / 1	1	0 / 1
	5	0 / 5	5	0 / 5 / 6 / 9
	1	0 / 1	1 / 4	0 / 1 / 4
	1	0 / 1	1 / 2	0 / 1 / 2
	1	–	1	0 / 1
	–	–	0 / 1	–

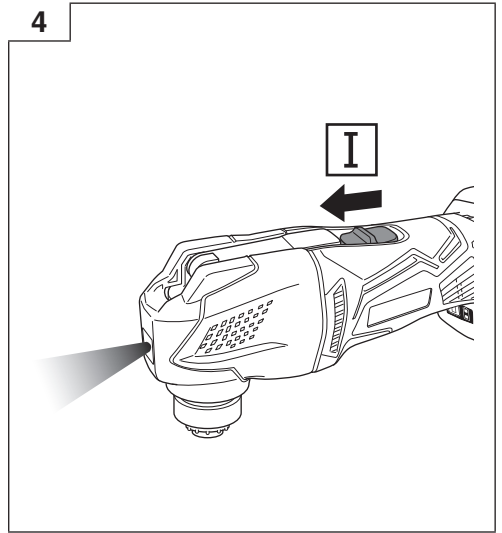
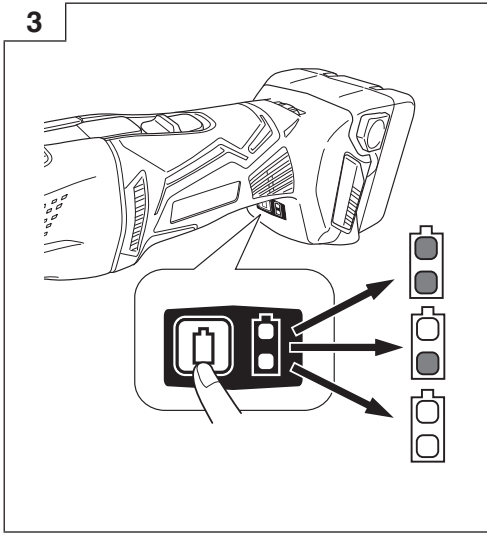
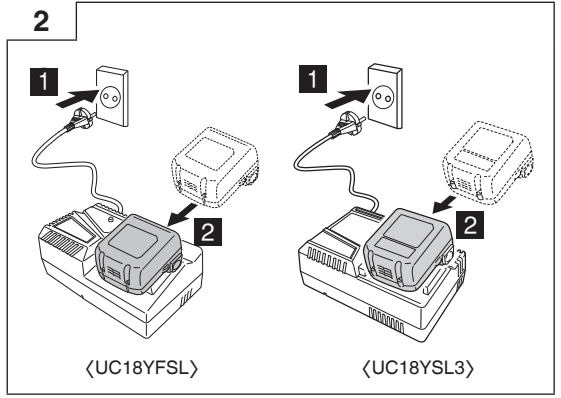
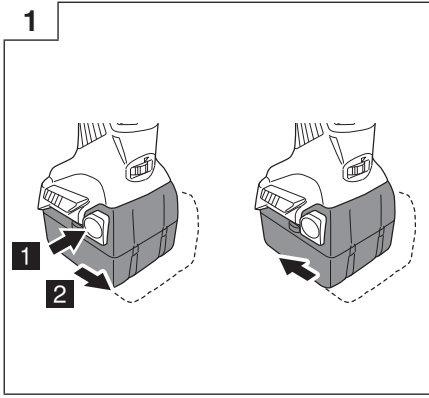

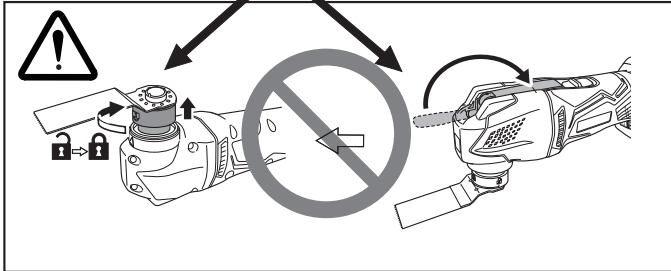
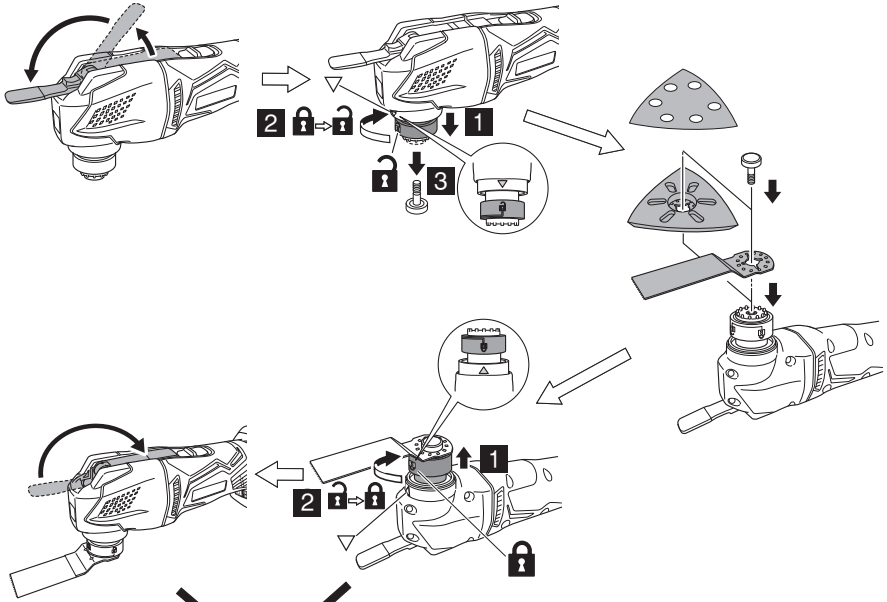

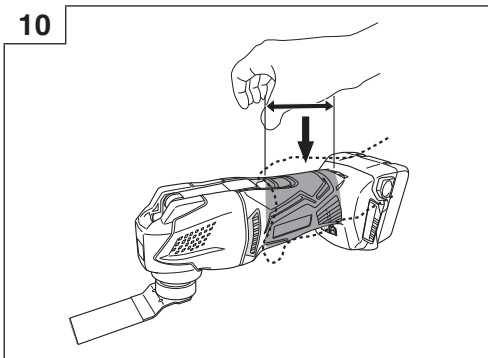
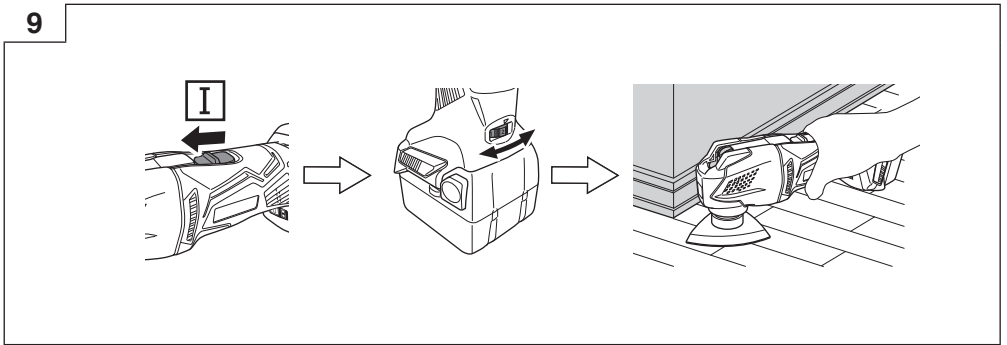
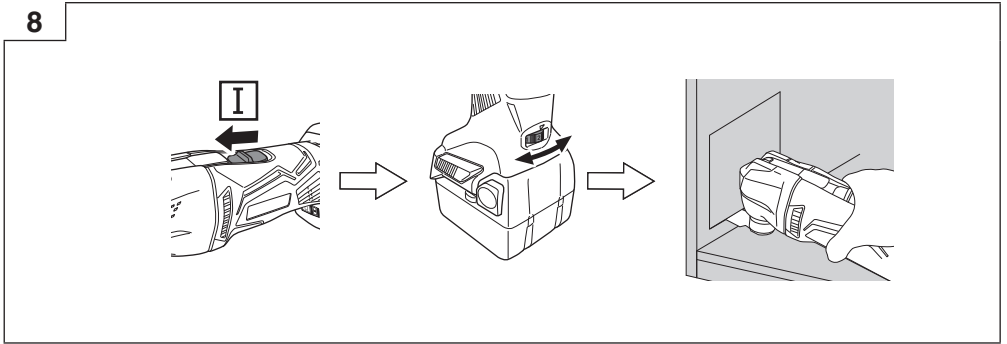
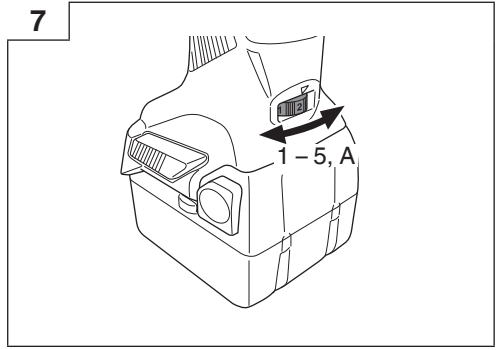
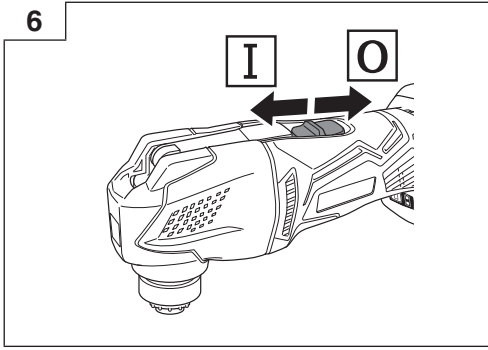

11

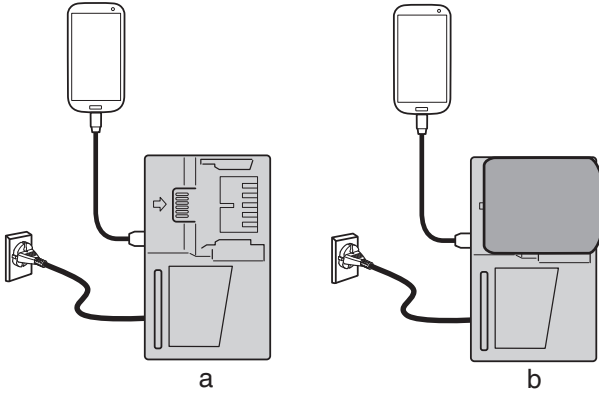

12

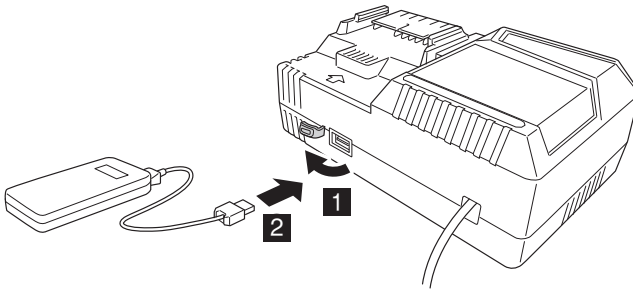

13

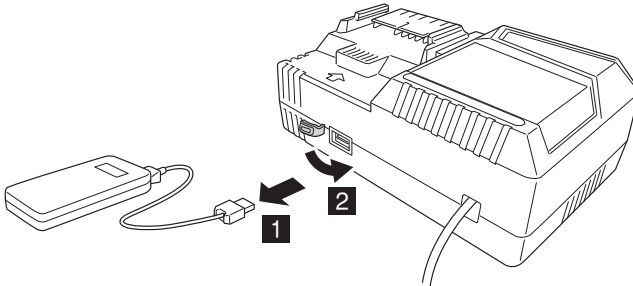

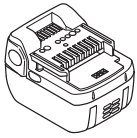

14.4V (Li-ion)

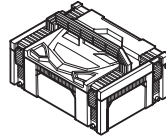
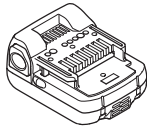

336471

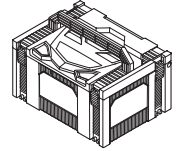

337108

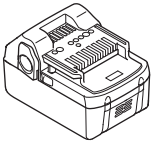

18V (Li-ion)

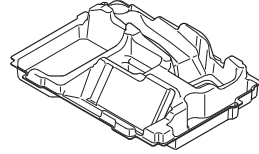
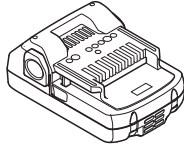

337937

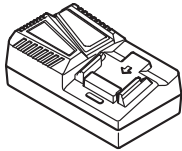

UC18YFSL (14.4V - 18V)

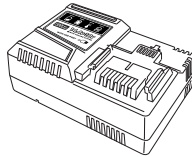

UC18YSL3 (14.4V - 18V)

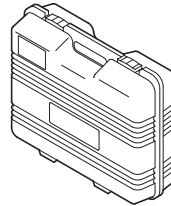

337684

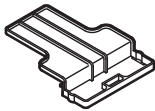

329897

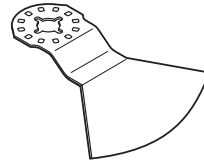

MU52PKR : 335901

MU52PK : 335902

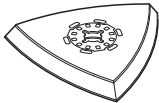

335903

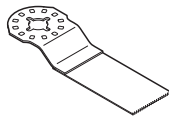

MW32P : 335871

MD28PB : 335881

MM32PB : 335883

MM20PB : 335884

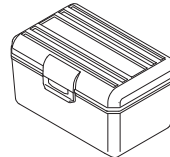

337685

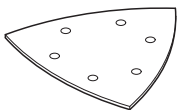

#60, 80, 100, 120, 180, 240

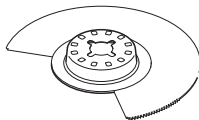

MW85S : 335868

MD85SB : 335880

MA85SH : 335897

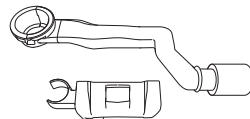

337936



Koki Holdings Co., Ltd.

Shinagawa Intercity Tower A, 15-1, Konan 2-chome,
Minato-ku, Tokyo, Japan