

CL200 Passage & Privacy

The CL200 range is durable sliding door hardware suitable for residential, commercial, and hospitality applications.

Privacy handles incorporate a patented magnetic latching system*, ensuring a smooth locking action. The symmetrical design makes handling easy - simply ensure the side handles are the desired orientation when fitting.

Two face plate widths are available. Handles can be adjusted to suit doors from 33 - 40mm or 40 - 46mm thick.

*Patent pending

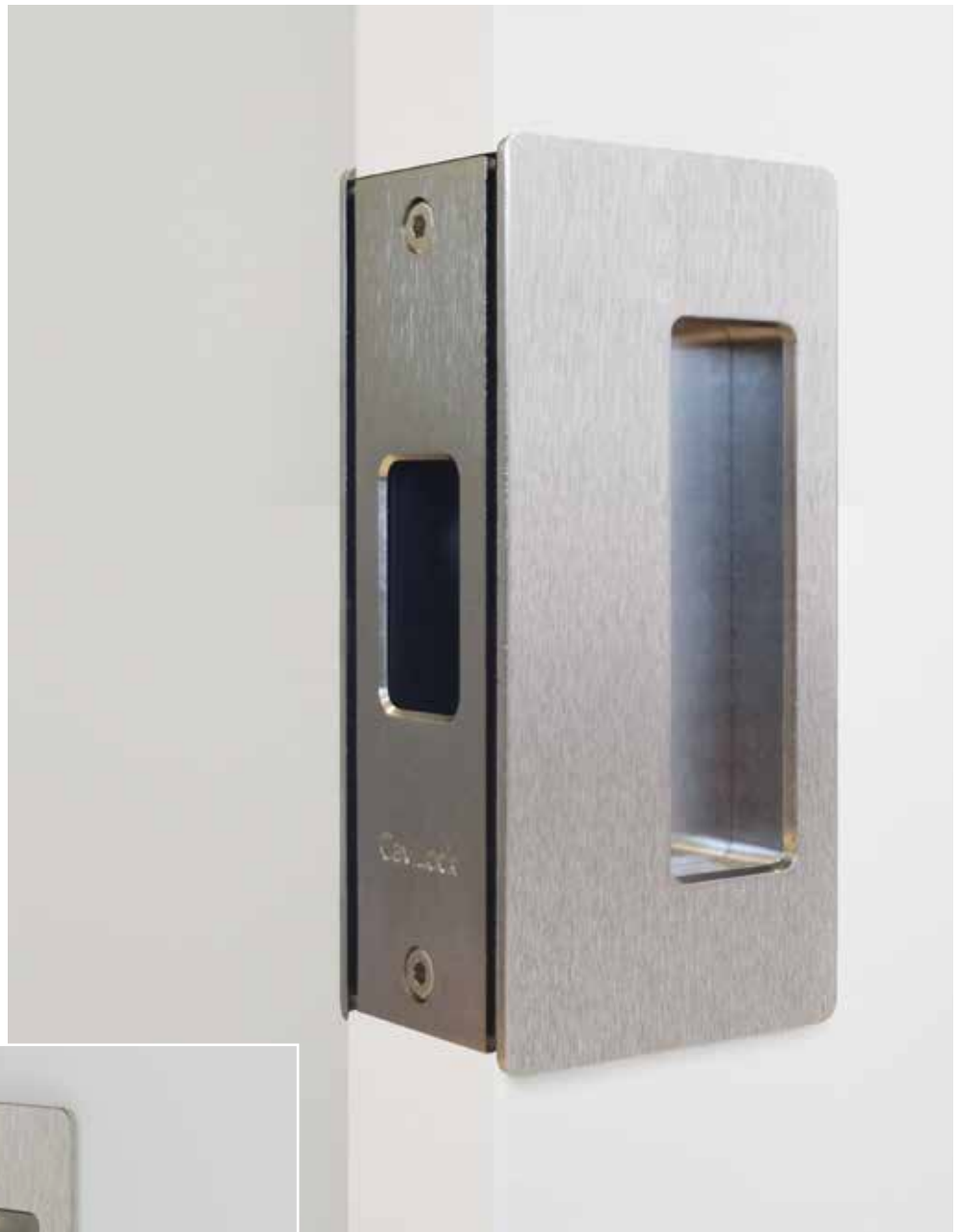

CaviLock CL200 Passage handle in Satin Chrome



CL200 Magnetic Privacy handle in Satin Nickel

Features

- ▮ Passage, Privacy and Bi-Parting options are available in a range of finishes.
- ▮ Suitable for use on timber or aluminium doors
- ▮ Integrated snib button allows more space in the side pull.
- ▮ Entire striker is encased by the finger pull, enabling the door to close completely flush.
- ▮ Large finger pull has more depth for greater purchase.
- ▮ Simple installation with easy to follow instructions.

Dimensions

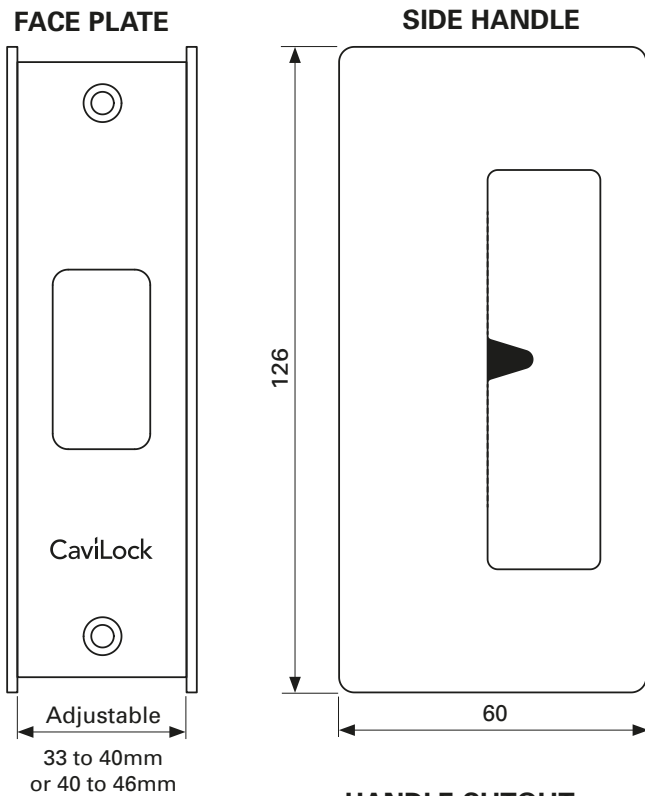

STRIKER

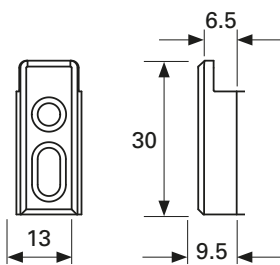

HANDLE CUTOUT

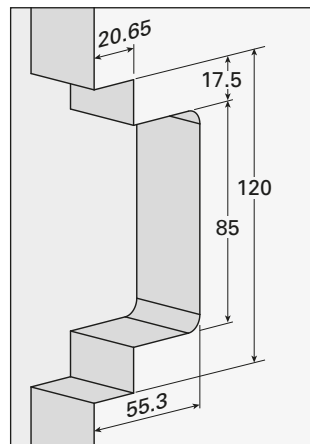

Configurations

CL205 A - Passage (non-latching)

Non-magnetic

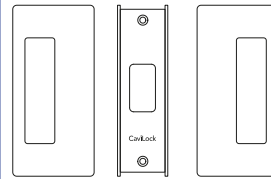

Passage handles are suitable for situations where locking or latching is not required. These handles do not have a striker or magnet.

CL205 D - Privacy Snib/Emergency

Magnetic Latch

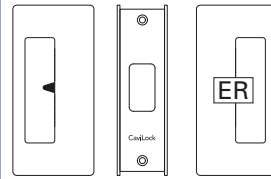

Privacy handles are supplied with a triangular shaped Snib on one side and Snib, Blank or Emergency Release on the other side.



Privacy Snib Button



Emergency Release

Snib/Snib

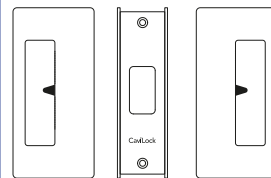

Snib One Side

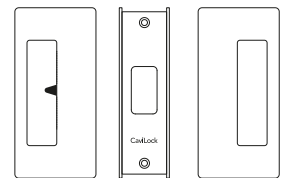

An alternative flush snib is available. Lead time applies.

Finish Options



Satin Chrome Bright Chrome Satin Nickel Oil Rubbed Bronze Matte Black

Non-standard finishes are available on request. Longer lead times and surcharges will apply.

CL205 C - Bi-Parting Mate (to latch with Privacy)

Magnetic Latch

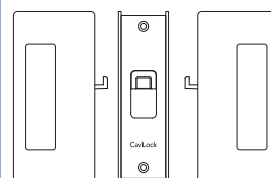

The Bi-Parting mate includes a striker on the face plate to enable it to magnetically latch with a privacy handle.

For Bi-Parting passage doors, order two single passage handles.

All copyright and other property in this document is reserved by Cavity Sliders Limited. Details and specifications are subject to change without notice. Whilst all care is taken to ensure the accuracy of all information, no responsibility will be accepted for any errors or omissions. © CAVILOCK is a Registered Trademark. Patent pending © Cavity Sliders Limited. CAVILOCK® CL200 MAGNETIC (O.D. 2017). 61260 - 09.2018

Drawings & pictures are not to scale. All dimensions in millimetres. © Cavity Sliders Limited.

info@csfordoors.co.nz
www.csfordoors.co.nz

Bay of Plenty / Waikato
T 07 928 0800
F 07 928 2525

Christchurch
T 03 348 6158
F 03 348 6150

Wellington
T 04 473 9994
F 04 473 9995

FOR DOORS
The Cavity Slider Experts

Auckland Head Office
T 09 276 0800
F 09 276 2525