

ION KITCHEN MIXER - BRUSHED NICKEL

44203.04

\$635

ELEMENTi

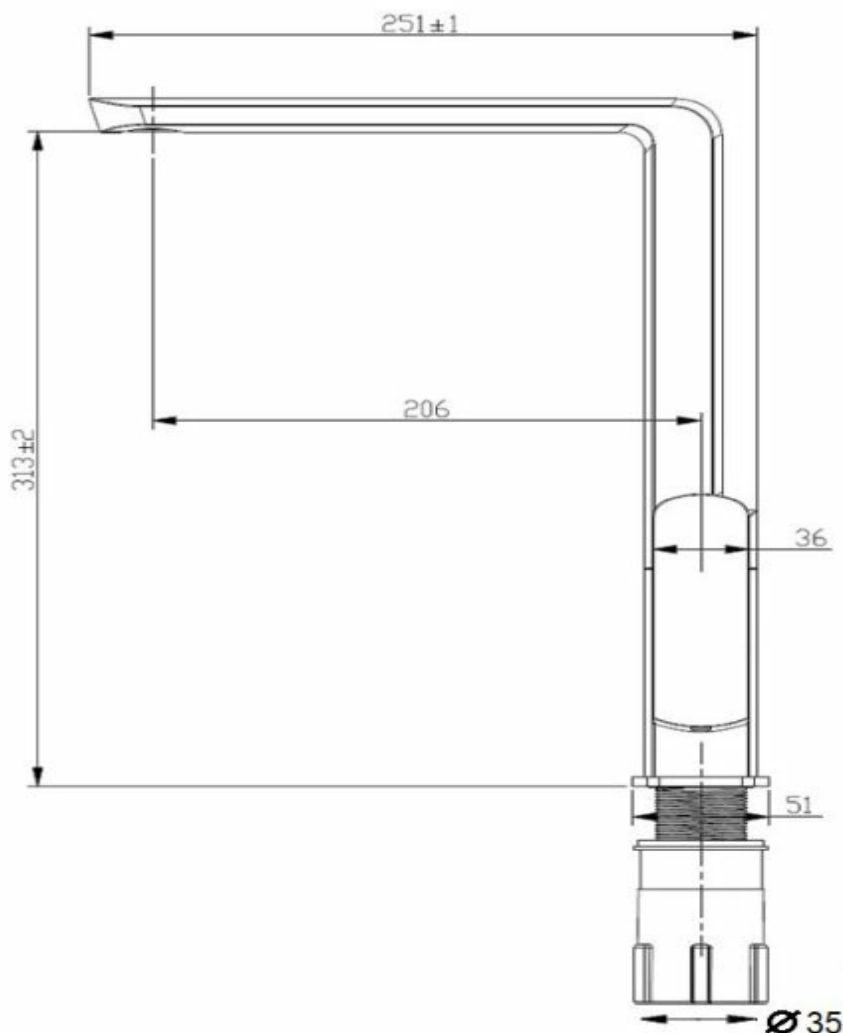

Residential/Light Commercial

Suitable for Residential/Light Commercial Use (Kitchens, Bathrooms and Laundries in Motels, Hotels and Retirement Villages)

10

Guarantee

10 Year Guarantee

5

Guarantee

5 Year Guarantee on coloured finish



4 Star WELS rating

More than 6.0 but not more than 7.5 litres per minute. Low/Unequal Pressure



5 Star WELS rating











More than 4.5 but not more than 6 litres per minute, Mains Pressure



Mains Pressure

Suitable for Mains Pressure.



	Multi Pressure	Suitable for Multi Pressure.
	Flawless Finish	Advanced plating provides a durable surface with a long lasting finish
	Effortless Control	Advanced cartridge technology provides a wide operating angle and smooth operation
	Smooth Flow	Aerator reduces scaling while delivering a smooth even flow
	Indicators	Includes standard and coloured indicators.
	Forward rotating handle	Forward rotating handle prevents the lever hitting the splashback.
	Chrome Plate	A base of copper is first applied followed by a layer of nickel and then finally a hard gloss coating of chromium to achieve a shiny hard wearing finish.
	Electroplated: Gun Metal	Electrical current is used to dissolve components into Lacquer that then adhere to the surface.
	Electroplated: Black	Electrical current is used to dissolve components into Lacquer that then adhere to the surface.
	Electroplated: Brushed Nickel	Electrical current is used to dissolve components into Lacquer that then adhere to the surface.

With flat profiling of the lever and spout combined with sleek lines and stylishly good looks, the new ION tapware collection from Elementi is a superior product in both looks (available in 4 finishes) and performance.