

DuratufTM

Quality - Made Affordable

ASSEMBLY INSTRUCTIONS



WS400 / BS400

BASE SIZE 1980mm x 1355mm



ASSEMBLY INSTRUCTIONS

Tools Required:

- Drill
- Drill Bit 3.5mm
- Riveter
- Hammer
- Nail Punch
- Tape Measure
- Ladder or Saw stool
- String Line
- Masonry Drill and 10mm Masonry Bit (for Bolt Down Kit only)

Before you start:

- Read all instructions carefully.
- Identify all parts and check quantities against checklist.
- If you are making your own floor refer to Raised Base Plate section now.

Safety:

- Do not attempt to build your shed in high winds.
- Beware of sharp edges.
- Protect your eyes and ears.
- Use electric tools with care. Use a Safety Trip Switch.
- It is easier and quicker if this shed is erected by two people.

Select your site:



- Your shed must be level. Achieve this by either levelling the ground or by using blocks.
- If your shed is to be positioned on wet or damp ground, we recommend that your shed is raised up off the ground slightly.

WS/BS400 PARTS LIST

COLOUR: _____

ROOF SIZE: 2.010 x 1.890

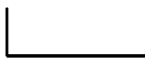
BASE SIZE: 1.980 x 1.355

QTY	LENGTH	DESCRIPTION	CHECKED OUT	CHECKED IN
4	1.890	Corner Wall Sheets	<input type="checkbox"/>	<input type="checkbox"/>
2	1.890	Wall Sheets	<input type="checkbox"/>	<input type="checkbox"/>
1	1.890	Roof Sheet	<input type="checkbox"/>	<input type="checkbox"/>
2	1.890	Folded Roof Sheets	<input type="checkbox"/>	<input type="checkbox"/>
TIMBER				
BASE PLATES				
2	1.980	Front & Back - Red 45 x 45 H4	<input type="checkbox"/>	<input type="checkbox"/>
2	1.355	Ends - Red 45 x 45 H4	<input type="checkbox"/>	<input type="checkbox"/>
TOP PLATES				
1	1.980	Back - Green 45 x 45 H1	<input type="checkbox"/>	<input type="checkbox"/>
1	1.980	Front - Green 70 x 45 H1	<input type="checkbox"/>	<input type="checkbox"/>
2	1.355	Ends - Green 45 x 45 H1	<input type="checkbox"/>	<input type="checkbox"/>
4	1.810	Studs - Yellow 45 x 45 H1	<input type="checkbox"/>	<input type="checkbox"/>
2	1.833	Studs - Blue 45 x 45 H1	<input type="checkbox"/>	<input type="checkbox"/>
4	1.265	End Wall Nogs 45 x 45 H1	<input type="checkbox"/>	<input type="checkbox"/>
2	0.106	Front Left Nog 45 x 45 H1	<input type="checkbox"/>	<input type="checkbox"/>
2	0.100	Front Right Nog 45 x 45 H1	<input type="checkbox"/>	<input type="checkbox"/>
2	1.890	Back Wall Nog 45 x 45 H1	<input type="checkbox"/>	<input type="checkbox"/>
FLASHINGS				
2	1.890	Door Jambs 	<input type="checkbox"/>	<input type="checkbox"/>
1	1.980	Top Plate Flashing 	<input type="checkbox"/>	<input type="checkbox"/>
1	2.010	Roof Flashing 	<input type="checkbox"/>	<input type="checkbox"/>
1		Hardware Pack	<input type="checkbox"/>	<input type="checkbox"/>
1		Assembly Instructions	<input type="checkbox"/>	<input type="checkbox"/>
1		Touch-up Paint & Brush	<input type="checkbox"/>	<input type="checkbox"/>

PACKED BY:

DATE: / /

WS400 TIMBER FRAME

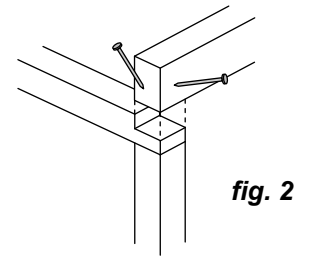
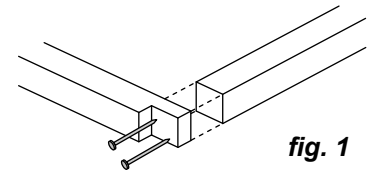
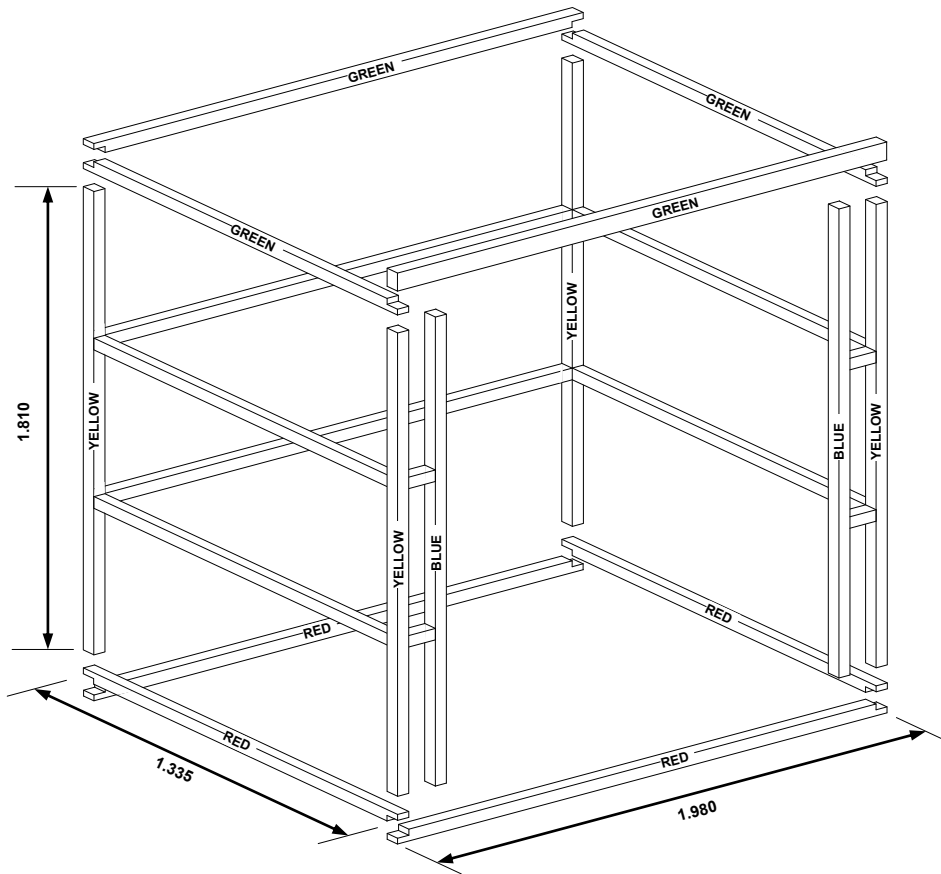

Note: For sheds being positioned on a Purpose Built Floor, shorten Studs by 30mm now (Refer to Floor Section).

Step 1: Select one End Base Plate 1.355m (Red), one End Top Plate 1.355m (Green) and two Studs (Yellow). Lay out on flat surface and nail together using two 75mm nails per joint (**fig. 1**). Evenly space two End Wall Nogs between Studs and nail in place. If fitting a seat in this shed, place bottom nogs so that the bottom of the nog is .400 up from the bottom of the base plate. Repeat with the other end frame.

Step 2: Select Back and Front Base Plates 1.980m (Red), Back Top Plate 1.980m (Green) and Front Top Plate (70x45mm). With one End Frame lying on the ground, nail plates to frame, two 75mm nails per joint. Ensure Red joins to Red and Green joins to Green. See (**fig. 2**) for nailing detail on Top Front Plate (70x45mm).

Step 3: Position remaining End Frame on top of plates. While someone supports frame, nail in place using two 75mm nails per joint.

Step 4: Carefully roll frame over onto its base. Nail on Back Wall Nogs evenly between Top and Bottom plate (this may be easier if the frame is rolled onto its Back wall). Nail Front Wall Studs (Blue) using Front Wall Nogs to get correct position, Nail remaining Front Wall Nogs in evenly (this may be easier if the frame is rolled onto its Front wall).

Step 5: Fit front Top Plate Flashing using four 30mm Clouts. Position Flashing so that the widest lip is on top.

1

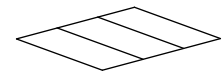

2

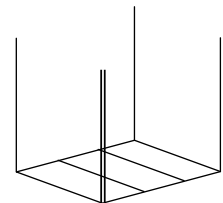

3

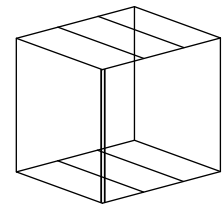

4

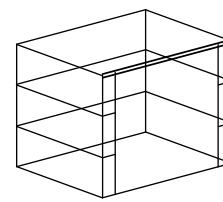

5

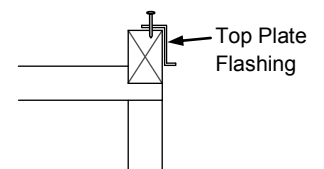

WS400 WALL CLADDING

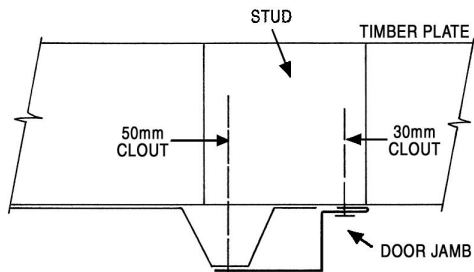
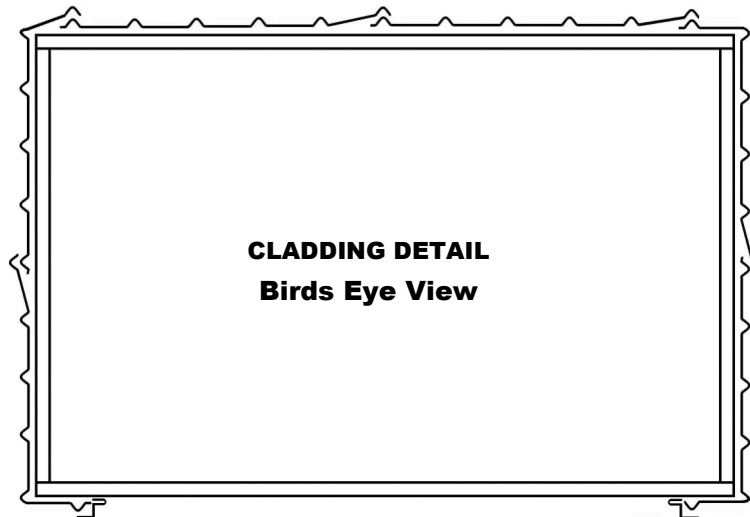

fig. 1

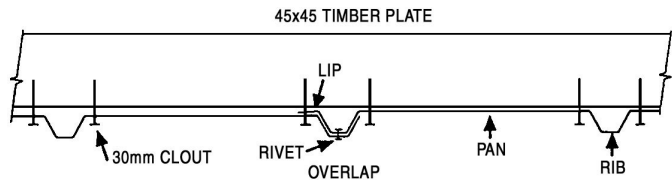
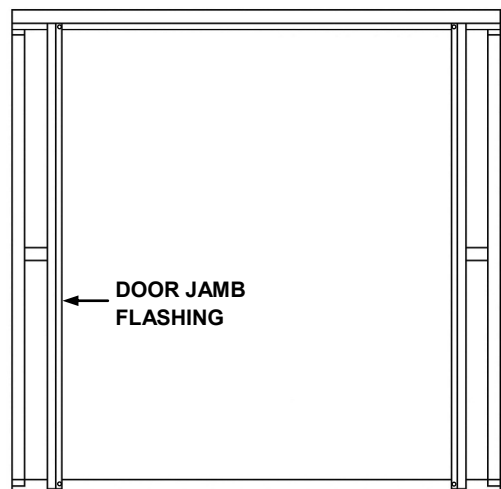

fig. 2

To Avoid Corrosion:

Where at all possible try not to trap metal filings between two sheets. Remove all metal filings before riveting. Carbon in pencils reacts with the Zinc/Aluminium coating on steel. Use ink to mark steel.

Step 1: Door Jambs: Position left hand Door Jamb Flashing so it lines up with door way stud and nail to Top Plate and Bottom Plate using a 30mm clout. Do not fit 50mm nails at this stage. Pre-drill holes to make nailing easier (*fig. 1*).



FRONT VIEW

WS400 WALL CLADDING

Step 2: NOTE: It is very important that the Wall Sheets are positioned exactly as shown in the **cladding detail** diagram on the previous page.

Position Corner Wall Sheets. Check that the Lip is on the correct side of the sheet. While holding Corner Wall Sheet flush with the top of the Top Plate, nail to plate using only one 30mm clout top and bottom.

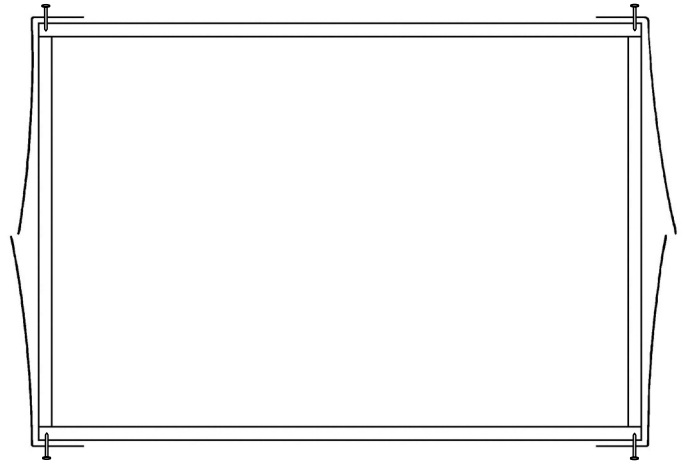

Birds Eye View

Step 3: Nail remaining Wall Sheets on ensuring lips are positioned as they are in the **Cladding Detail** and tops of sheets are flush with top of Top plate.

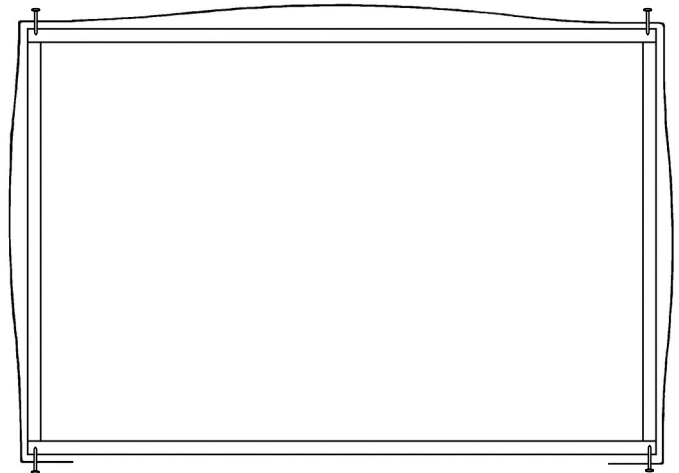

↑ = 30mm Clout

Step 4: Nail Wall Sheets to Plates, two 30mm Clouts per pan top and bottom.

Nail Wall Sheets to Wall Nogs, one clout per pan.

Step 5: Drill a hole through Door Jamb Flashings and Wall Sheets top and bottom. Nail with 50mm nails (**fig. 1**).

Nail left hand Door Jamb Flashing to Stud using three 30mm Clouts at equal spacings (**fig. 1**). Beside each 30mm Clout, rivet Door Jamb Flashing to Rib. Repeat with right hand Door Jamb Flashing.



WS400 ROOF

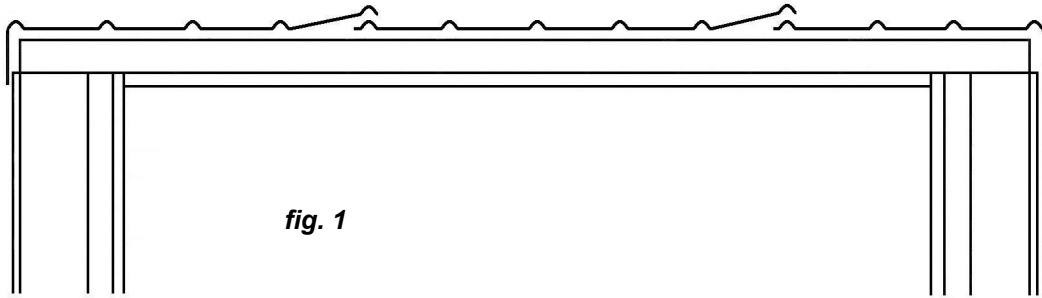

Step 1: Note: Condensation can form on the under side of shed roof. If building paper is required, fit now. Building paper will need to be supported by netting or roofing twine.

Position Roof Sheets as shown in **fig 1**. Make sure sheet joints at the back are flush. Rivet sheet joins, one rivet 200mm back from edge front and back. Fit one more rivet in centre of each join.

Step 2: Position Roof so that the front overhang measures 450mm. Rivet roof to wall sheets using one rivet every second Rib. Repeat at the other end ensuring overhang measures 450mm.



Step 3: Line up ribs on the roof with ribs on the walls. While someone holds the Front Plate straight, nail the roof to Top Plate using one 40mm Weatherseal nail beside each rib. Repeat at the back (a string line can be used to make this easier).



Step 4: Fit Roof Flashing as shown. When positioned correctly rivet through Roof Flashing into Roof Sheet joins.



WS400 FLOOR (Optional)

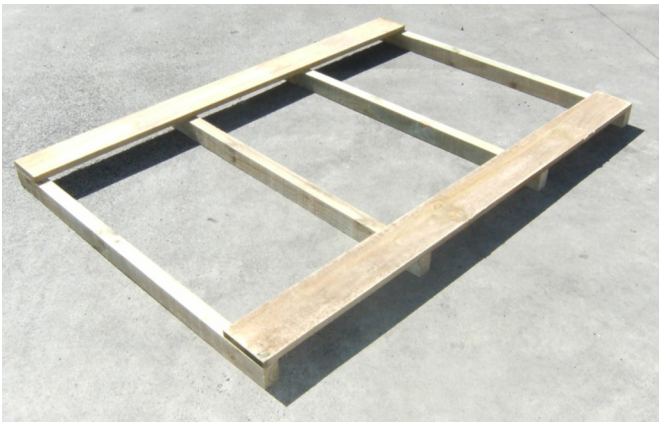

Step 1: Position two Floor Boards at front and back of the four bearers provided. Nail one 50mm nail into each corner. Check Floor is square by measuring diagonals. Once square put another nail in each end of the boards to hold position.

Step 2: Lay out remaining Floor Boards evenly allowing small gaps between boards for air circulation. Nail in each Floor Board, two 50mm nails each end and two into each Floor Joist.

Step 3: Place Shed on top of Floor and screw Shed to Floor using eight 75mm screws

SHELTER BENCH

Step 1: Make centre Brace by selecting two Brace Verticals (310mm) and two Brace Horizontals (405mm) and screw together with 75mm screws as shown

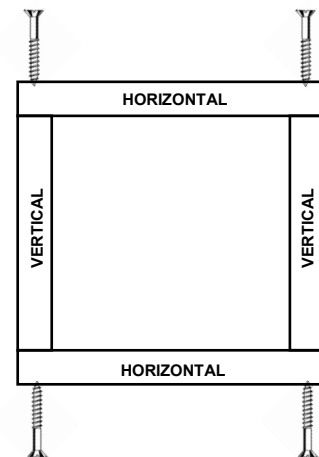

Step 2: Place three Seating boards on lower side nogs, hard against the back studs. Place Centre Brace centrally under Boards.

Screw each Board to nogs and Brace with two 75mm screws at each end and into Brace.

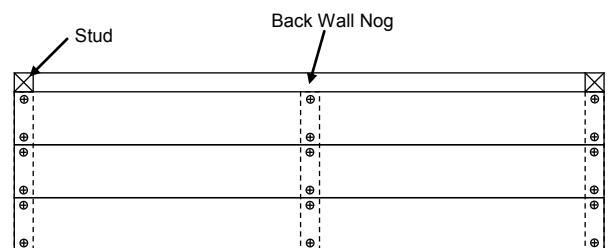

⊙ = Screws

Step 3: If you have installed a Floor screw bottom of Brace into Floor with two 75mm screws.

PURPOSE BUILT FLOOR

i.e. CONCRETE / PLYWOOD

For sheds being placed on a purpose built floor, we recommend that the studs are shortened by 30mm. The Wall Sheets will then protrude 20mm below the Base Plate. This will stop water flowing in between the Base Plate and Floor.

If you choose this option, the Floor should be made 15mm smaller than Base Size.

Note: Although it is not essential, fitting Damp Proof Course in between the Base Plate and the Floor will give added protection against moisture.

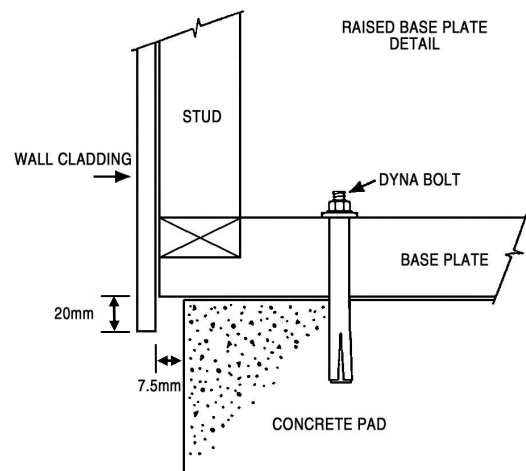

CLEAN UP

- Remove all metal filings with a soft brush or rag.
- Hose down roof and walls thoroughly.

PAINTING

- Painting Zinc/Aluminium coated steel will extend its life in most environments
- The surface must be dry and free of dirt, oil, grease and other contaminants prior to painting, but no weathering of the surface is required
- Zinc rich primers are recommended for use, along with a two coat finishing system. Paint suppliers should be consulted for the most suitable paint system to ensure compatibility of primers and topcoats.