

Duratuf[®] FORTRESS SHEDS

Quality - Made Affordable

ASSEMBLY INSTRUCTIONS



TUF 100

BASE SIZE 1140mm x 1690mm



ASSEMBLY INSTRUCTIONS

Tools Required:

- Drill
- Drill Bit 3.5mm
- Drill Bit 6mm (for clear roof panel only)
- Riveter
- Hammer
- Nail Punch
- Tape Measure
- Ladder or Saw stool
- String Line
- Masonry Drill and 10mm Masonry Bit (for Bolt Down Kit only)

Before you start:

- Read all instructions carefully.
- Identify all parts and check quantities against checklist.
- If you are making your own floor refer to Raised Base Plate section now.

Safety:

- Do not attempt to build your shed in high winds.
- Beware of sharp edges.
- Protect your eyes and ears.
- Use electric tools with care. Use a Safety Trip Switch.
- It is easier and quicker if this shed is erected by two people.

Select your site:



- Your shed must be level. Achieve this by either levelling the ground or by using blocks.
- If your shed is to be positioned on wet or damp ground, we recommend that your shed is raised up off the ground slightly.

TUF 100 PARTS LIST

COLOUR: _____ INV #: _____

ROOF SIZE: 1.175 x 1.890

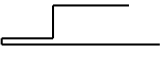
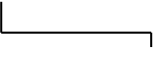
BASE SIZE: 1.140 x 1.690

QTY	LENGTH	DESCRIPTION	CHECKED OUT	CHECKED IN
3	1.890	Corner Wall Sheets	<input type="checkbox"/>	<input type="checkbox"/>
1	1.890	3/4 Corner Wall Sheet (D008)	<input type="checkbox"/>	<input type="checkbox"/>
1	1.890	Wall Sheet	<input type="checkbox"/>	<input type="checkbox"/>
2	1.890	1/2 Wall Sheets	<input type="checkbox"/>	<input type="checkbox"/>
2	1.890	Folded Roof Sheets	<input type="checkbox"/>	<input type="checkbox"/>
1		Door	<input type="checkbox"/>	<input type="checkbox"/>
TIMBER				
BASE PLATES				
2	1.140	Front & Back - Green 45 x 45 H4	<input type="checkbox"/>	<input type="checkbox"/>
2	1.690	Ends - Green 45 x 45 H4	<input type="checkbox"/>	<input type="checkbox"/>
TOP PLATES				
1	1.140	Back - Red 45 x 45 H1	<input type="checkbox"/>	<input type="checkbox"/>
1	1.140	Front - Red 70 x 45 H1	<input type="checkbox"/>	<input type="checkbox"/>
2	1.690	Ends - Red 45 x 45 H1	<input type="checkbox"/>	<input type="checkbox"/>
4	1.810	Studs - Yellow 45 x 45 H1	<input type="checkbox"/>	<input type="checkbox"/>
1	1.833	Studs - Blue 45 x 45 H1	<input type="checkbox"/>	<input type="checkbox"/>
2	1.600	End Wall Nogs 45 x 45 H1	<input type="checkbox"/>	<input type="checkbox"/>
1	0.106	Front Wall Nog 45 x 45 H1	<input type="checkbox"/>	<input type="checkbox"/>
1	1.050	Back Wall Nog 45 x 45 H1	<input type="checkbox"/>	<input type="checkbox"/>
FLASHINGS				
2	1.890	Door Jambs 	<input type="checkbox"/>	<input type="checkbox"/>
1	1.160	Top Plate Flashing 	<input type="checkbox"/>	<input type="checkbox"/>
1	1.175	Roof Flashing 	<input type="checkbox"/>	<input type="checkbox"/>
1		Hardware Pack	<input type="checkbox"/>	<input type="checkbox"/>
SECURITY				
2		Latches	<input type="checkbox"/>	<input type="checkbox"/>
1		Assembly Instructions	<input type="checkbox"/>	<input type="checkbox"/>
1		Touch-up Paint & Brush	<input type="checkbox"/>	<input type="checkbox"/>

PACKED BY: _____

DATE: / /

TUF 100 TIMBER FRAME

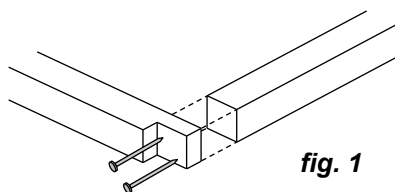
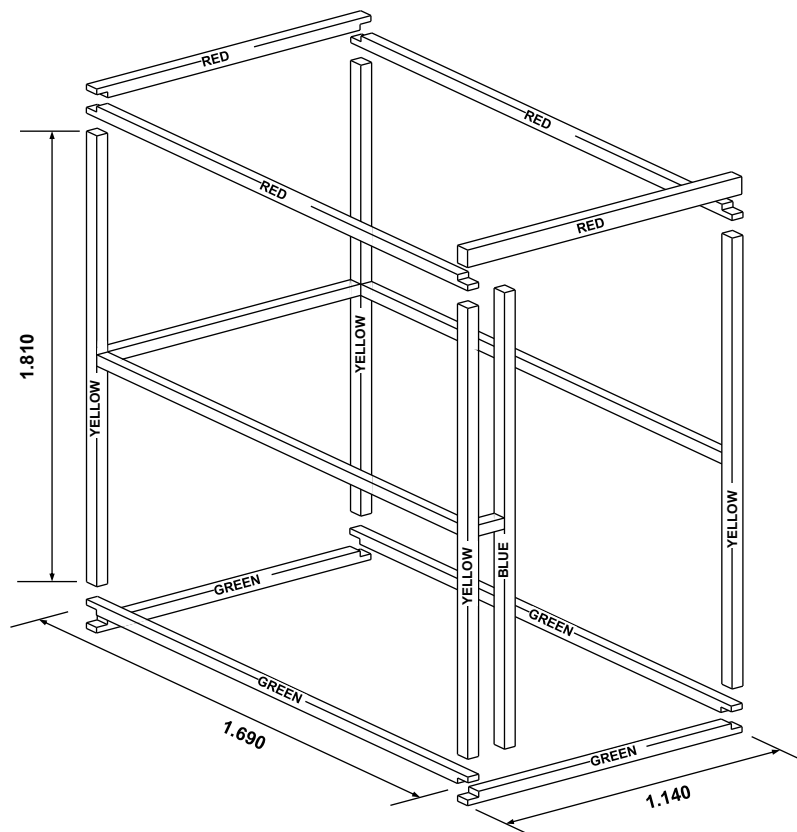

fig. 1

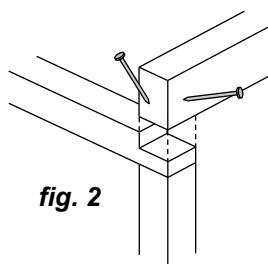

fig. 2

Note: For sheds being positioned on a Purpose Built Floor, shorten Studs by 30mm now (Refer to Floor Section).

Step 1: Select one End Base Plate 1.690m (Green), one End Top Plate 1.690m (Red) and two Studs (Yellow). Lay out on flat surface and nail together using two 75mm nails per joint (**fig. 1**). Repeat with the other end frame.

Step 2: Select Back and Front Base Plates 1.140m (Green), Back Top Plate 1.140m (Red) and Front Top Plate (70x45mm). With one End Frame lying on the ground, nail plates to frame, two 75mm nails per joint. Ensure Green joins to Green and Red joins to Red. See (**fig. 2**) for nailing detail on Top Front Plate (70x45mm).

Step 3: Position remaining End Frame on top of plates. While someone supports frame, nail in place using two 75mm nails per joint.

Step 4: Carefully roll frame over onto its base. Nail on Back and End Wall Nogs .882m above the top of the Bottom plate. If fitting a Duratuf Floor, fit Floor Joist now. Evenly space joist and nail in place using three 75mm nails per end. Nail Front wall Stud (Blue) using Front Wall Nog to get correct position, Nail Front Wall Nog in centrally (this may be easier if the frame is rolled onto its Front wall).

Step 5: Fit front Top Plate Flashing centrally on Front Top Plate using four 30mm Clouds. Position Flashing so that the widest lip is on top.

1

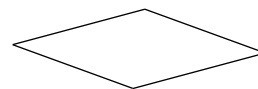

2

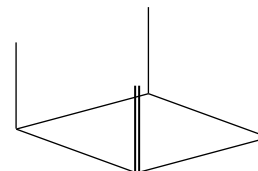

3

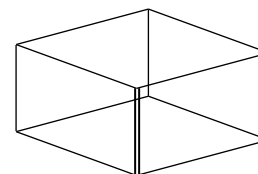

4

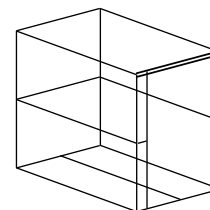

5

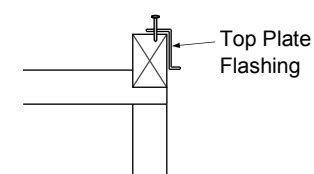

TUF 100 WALL CLADDING

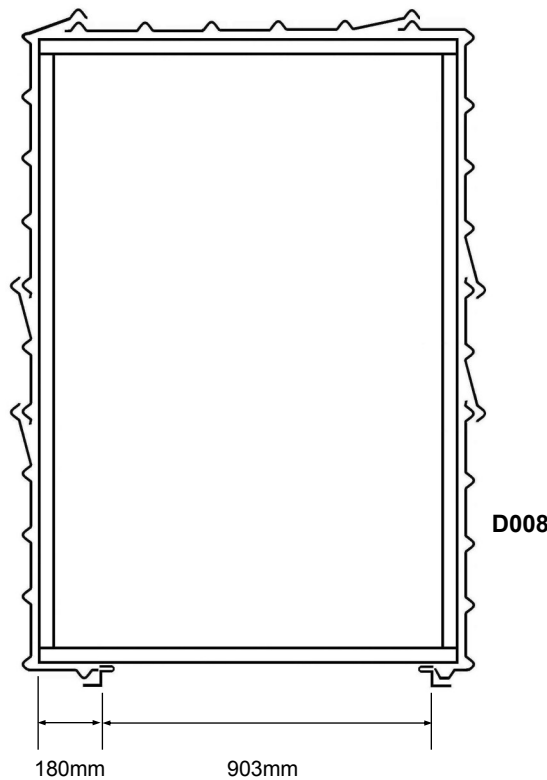

CLADDING DETAIL
Birds Eye View

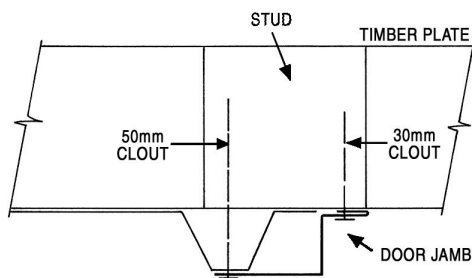

fig. 1

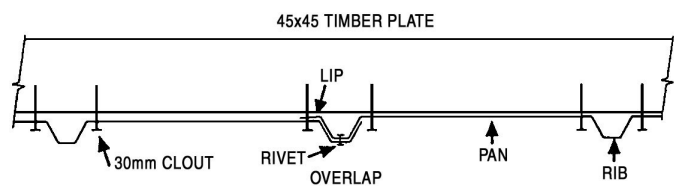

fig. 2

To Avoid Corrosion:

Where at all possible try not to trap metal filings between two sheets. Remove all metal filings before riveting. Carbon in pencils reacts with the Zinc/Aluminium coating on steel. Use ink to mark steel.

Step 1: Door Jambs: Position left hand Door Jamb Flashing at correct measurement from left (**cladding detail**) and nail to Top Plate using a 30mm clout. Do not fit 50mm nails at this stage. Pre-drill holes to make nailing easier (**fig. 1**).

Position Door Jamb Flashing and nail at the bottom. Position right hand Door Jamb Flashing 903mm from left hand Door Jamb Flashing (**cladding detail**) and nail in place.

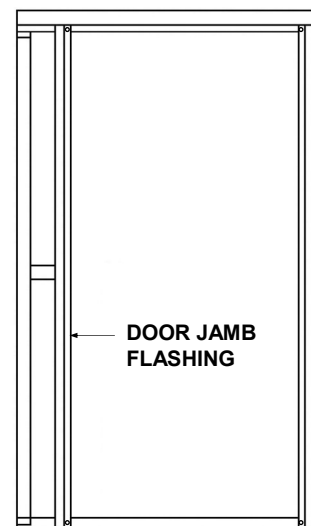

FRONT VIEW

TUF 100 WALL CLADDING

Step 2: NOTE: It is very important that the Wall Sheets are positioned exactly as shown in the **cladding detail** diagram on the previous page.

Position Corner Wall Sheets. Check that the Lip is on the correct side of the sheet. While holding Corner Wall Sheet flush with the top of the Top Plate, nail to plate using only one 30mm clout top and bottom.

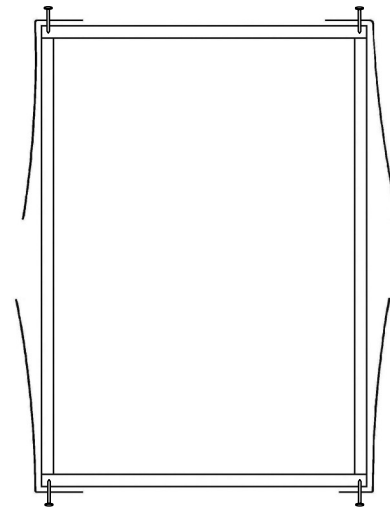

Birds Eye View

↓ = Rivet

⌋ = 30mm Clout

Step 3: Position All remaining Wall Sheets. Ensure they overlap correctly then rivet to Corner Wall Sheets, one rivet top and bottom on each overlap.

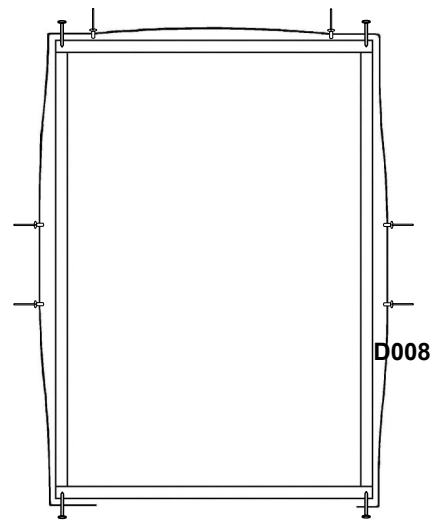

D008

Step 4: Nail Wall Sheets to Plates, two 30mm Clouts per pan top and bottom.

Nail Wall Sheets to Wall Nogs, one clout per pan.

Step 5: Drill a hole through Door Jamb Flashings and Wall Sheets top and bottom. Nail with 50mm nails (**fig. 1**).

Nail left hand Door Jamb Flashing to Stud using three 30mm Clouts at equal spacings (**fig. 1**). Beside each 30mm Clout, rivet Door Jamb Flashing to Rib. Repeat with right hand Door Jamb Flashing.



TUF 100 ROOF

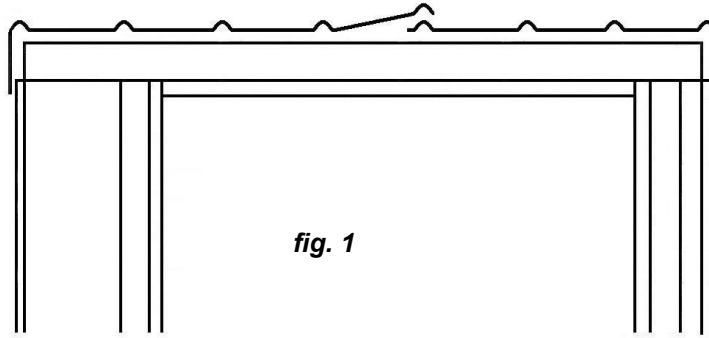

Step 1: Note: Condensation can form on the under side of shed roof. If building paper is required, fit now. Building paper will need to be supported by netting or roofing twine.

Roof: Position Roof Sheets as shown in **fig 1**. Make sure sheet joints at the back of the roof are flush. Rivet sheet joints, one rivet 200mm back from edge front and back. Fit two more rivets evenly spaced in centre of each joint.

Step 2: Position Roof so that the front overhang measures 140mm. Rivet roof to wall sheets using one rivet every second Rib. Repeat at the other end ensuring overhang measures 140mm.



Step 3: Line up ribs on the roof with ribs on the walls. While someone holds the Front Plate straight, nail the roof to Top Plate using one 40mm Weatherseal nail beside each rib. Repeat at the back.

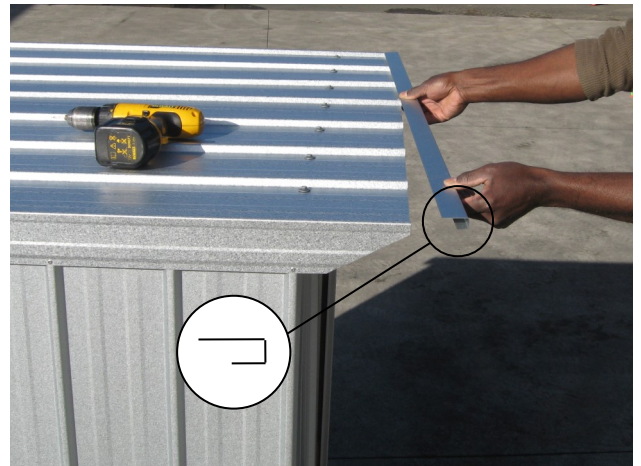

Step 4: Fit Roof Flashing as shown. When positioned correctly rivet through Roof Flashing into Roof Sheet joints.

TUF 100 DOOR

NOTE: If shed has an optional security upgrade, please use Security door instructions on next page.

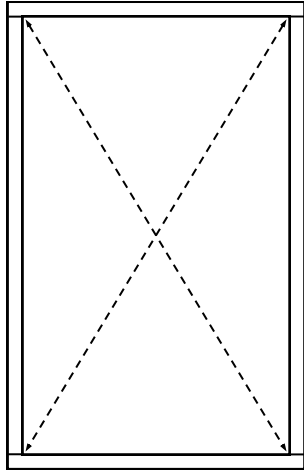

Step 1: Place shed in final position. Check diagonal measurements are equal and shed is level before fitting door.



Step 2:

Hold Door in position (approximately 5mm down from Top Plate Flashing) and fit one rivet to top hinge. While still holding in position fit one rivet to bottom hinge.



Step 3: Close door and check it fits correctly. If not, drill out rivets and make necessary adjustments. Fit remaining rivets to all three hinges.



Step 4: Using rivets attach padlock as shown.

FORTRESS SECURITY DOOR (Optional)

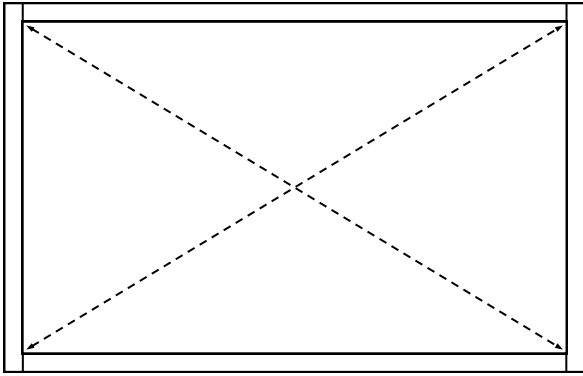

Step 1: Place shed in final position. Check diagonal measurements are equal and shed is level before fitting door.



Step 2: Hold Door in position (approximately 5mm down from Top Plate Flashing) and fit one rivet to top hinge. While still holding in position fit one rivet to bottom hinge.



Step 3: Close door and check it fits correctly. If not, drill out rivets and make necessary adjustments. Fit remaining rivets to all three hinges.



Step 4: Slide the latch on to the handle shaft. Enter shed, close door and adjust latch so it is snug with the stud at the side of the door. Tighten up bolt on latch.

Note: Repeat Step 4 for second door handle if double security doors.

TUF 100 FLOOR (Optional)



Step 1: Select the two Floor Boards which have checked out corners. Position at front and back of the shed so they fit around Studs.

Step 2: Lay out remaining Floor Boards. Nail in each Floor Board, two 50mm nails each end and two into each Floor Joist.

PURPOSE BUILT FLOOR

i.e. CONCRETE / PLYWOOD

For sheds being placed on a purpose built floor, we recommend that the studs are shortened by 30mm. The Wall Sheets will then protrude 20mm below the Base Plate. This will stop water flowing in between the Base Plate and Floor.

If you choose this option, the Floor should be made 15mm smaller than Base Size.

Note: Although it is not essential, fitting Damp Proof Course in between the Base Plate and the Floor will give added protection against moisture.

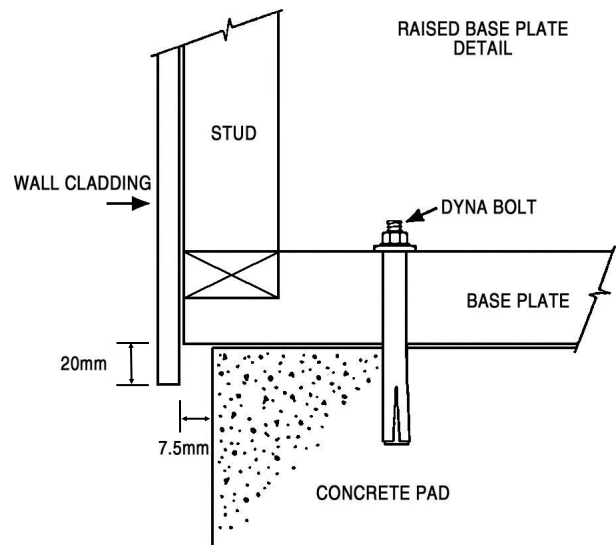

CLEAN UP

- Remove all metal filings with a soft brush or rag.
- Hose down roof and walls thoroughly.

PAINTING

- Painting Zinc/Aluminium coated steel will extend its life in most environments
- The surface must be dry and free of dirt, oil, grease and other contaminants prior to painting, but no weathering of the surface is required
- Zinc rich primers are recommended for use, along with a two coat finishing system. Paint suppliers should be consulted for the most suitable paint system to ensure compatibility of primers and topcoats.





DURATUF PREMIUM SHED WARRANTY

REFERENCE NO: _____

GUARANTEE TO CUSTOMER

Congratulations on purchasing a Duratuf Storage Shed. With proper care and attention, this product will last many years. For your benefit **PLEASE READ THE FOLLOWING INFORMATION CAREFULLY.**

WARRANTY ON METAL CLADDING

Riverlea Group Ltd guarantee that the metal roofing and wall cladding on Kiwi and Fortress Garden Sheds may be used in moderate and inland corrosion zones or areas where the first year mild steel corrosion rate is less than 200g/m², and that in these conditions, they will not perforate due to corrosion within 18 years of date of manufacture.

TERMS AND CONDITIONS

1. Damage or corrosion due to the following circumstances is not covered by this warranty.
 - ◆ Mechanical, chemical or other damage sustained during or after installation.
NOTE: Clean swarf off shed **IMMEDIATELY** after assembly
Do **NOT** mark cladding with pencil
Do **NOT** allow manures, chemicals or other corrosive materials to have direct contact with cladding
Chemical damage will result if these instructions are not carried out
 - ◆ Force majeure or other causes beyond the control of Riverlea Group Ltd.
2. This warranty does not cover material installed in severe and very severe environmental situations, or in any area where the mild steel corrosion rate (as published by BRANZ) exceeds 200g/m².
3. Minimum maintenance must be carried out in accordance with instructions below.

Should the cladding fail to perform as specified above, the liability of Riverlea Group Ltd shall in all cases be limited to replacing or repairing the defective product. The balance of the original warranty will cover any repaired or replaced material. Riverlea Group Ltd will not be liable for any consequential loss or damage, labour or transport charges. All claims made in writing within 21 days of discovery, quoting the reference number at the top right hand corner of this page.

MAINTENANCE

Following are the minimum maintenance requirements for cladding used in Kiwi Garden Sheds and Fortress Sheds.

- ◆ Washing all surfaces by rain, and annual hosing of sheltered areas using a hose and soft nylon brush.
- ◆ Within 2km of coast—wash every 3 months as above. After a storm, wash the cladding and the gutters as soon as possible to remove any highly corrosive salt deposits.
- ◆ Volcanic Ash Fallout—wash as soon as possible, removing fallout from roof and gutters
- ◆ Gutters to be kept clean of leaves and dirt.

Should you require additional technical information please contact us at the details below.

Thank you
Riverlea Group Customer Services