

RONDO®
EXANGLE®
Finishing Sections

EXANGLE® installation guide

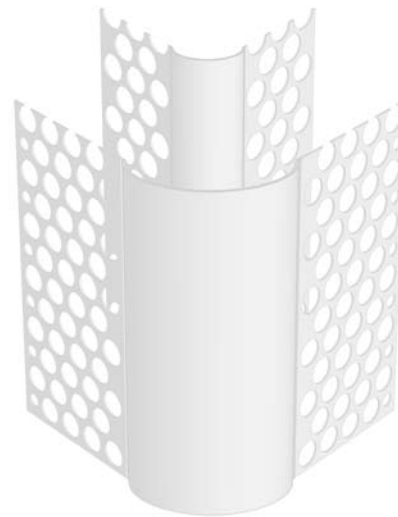

RONDO EXANGLE®

Finishing Sections

CORNER BEADS

90° external corner beads are available in two profiles. Use P01 for a sharper finish or P32 for a slightly more rounded corner. Both profiles are also available in 135° for splayed external corners (P01A or P32A respectively).

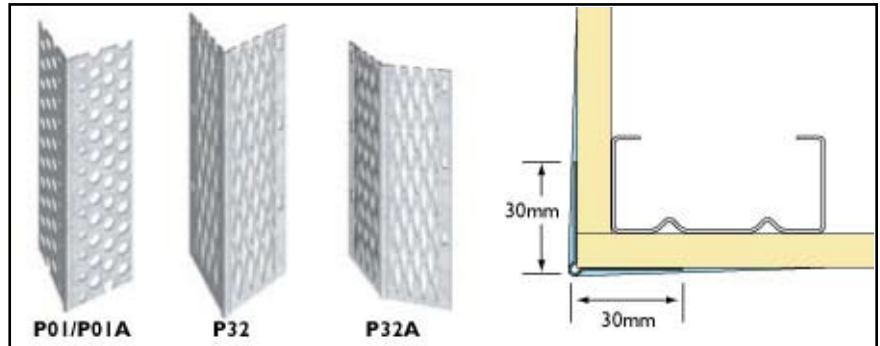

INTERNAL CORNER BEADS

For internal 90° corners use PS17, or PSIA for internal 135° corners. Suitable for both Plasterboard and Fibre Cement, the raised centre of the bead provides a guide for the setting trowel to allow maximum penetration of setting compound.

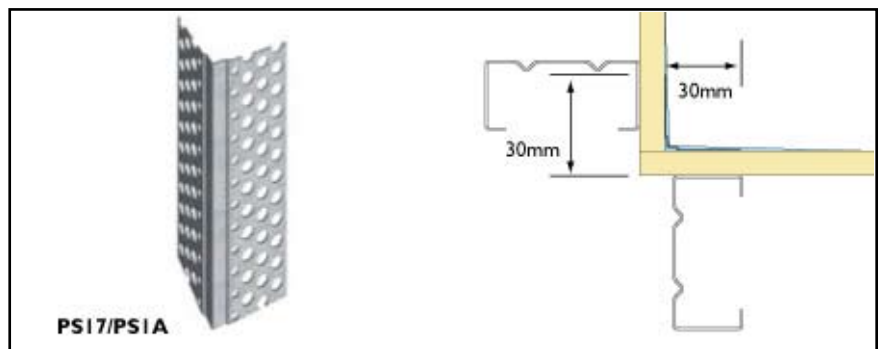

STOPPING BEADS

Rondo Stopping Beads P11, P12, P13 & P14 can be used to fit 6, 10, 13, and 16mm boards respectively, capping the exposed end of the board.

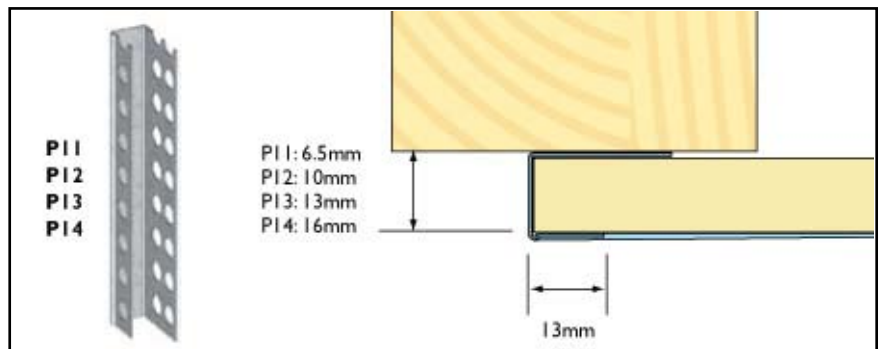

STOPPING ANGLES

Rondo Stopping Angles P25, P26 and P27 are made to suit 10, 13 and 16mm boards respectively. Suitable for use in applications where the edge of the board is not exposed, such as around a door jamb.

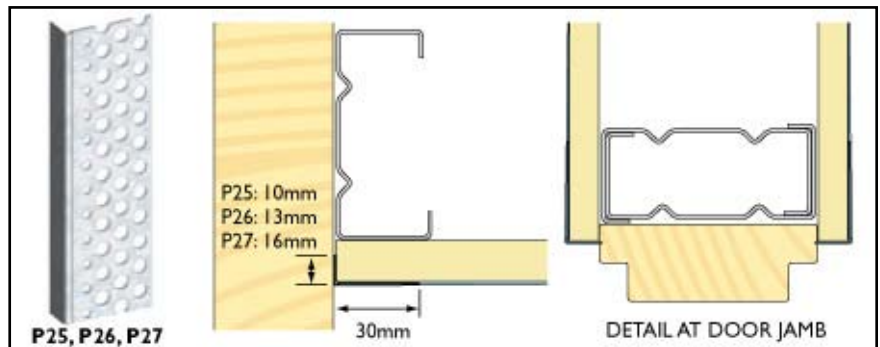

SHADOWLINE STOPPING ANGLES

Shadow-line Stopping Angles produce a recessed feature which also minimizes problems caused by misaligned wall and ceiling junctions. Available in two profiles; the P50 to allow a 10x10mm recess, up to 16mm board; and the P60 which gives a 6x10mm recess and is suitable for 6mm board.

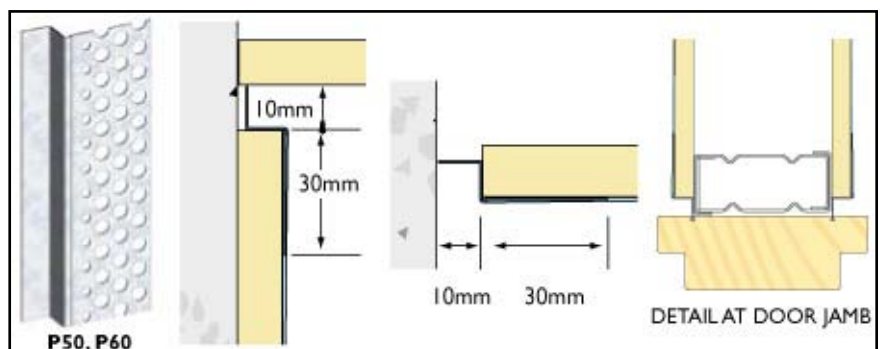

CONTROL JOINTS

Suitable for use in both walls and ceilings, the P35 is approved for use in fire-rated environments. It is also recommended for use where dissimilar building materials are joined to cater for differential movement.

INSTALLATION:

- Allow a maximum 20mm gap between the boards and ensure a complete break in any framing behind the joint.
- Locate the P35 centrally in the gap and fasten the flanges to the boards at maximum of 150mm centres.
- Apply setting compound over the beads and finish the joint normally.
- When the joint is dry remove the protective tape ready for painting.

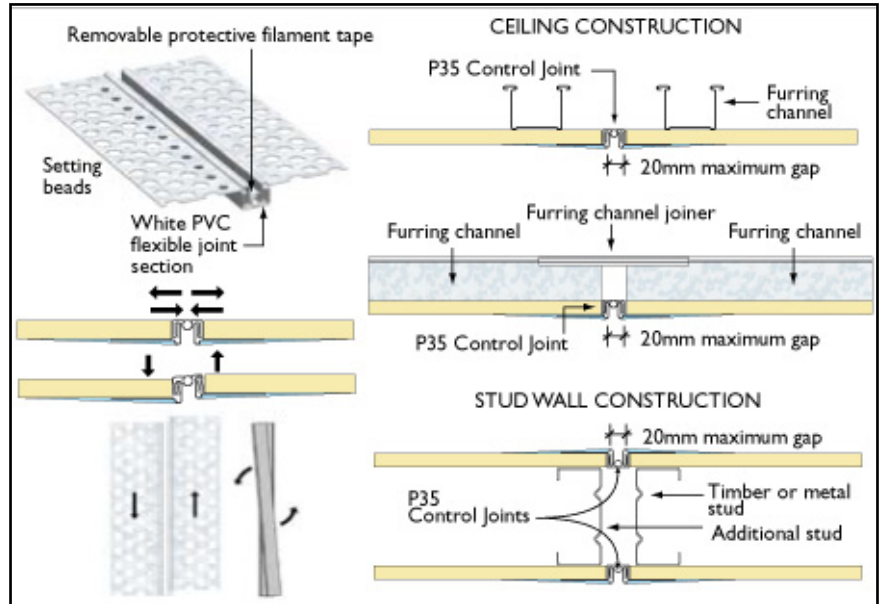

ARCH-BEADS

Rondo P10 and P30 are suitable for use in archways. Both profiles produce a seamless, professionally finished, arched corner, however the P30 permits smaller arches to be trimmed.

INSTALLATION:

- Fit the short perforated leg of the bead to the face of the wall.
- Carefully bend the bead to suit the arch profile
- Extend arch bead 150mm below Springing Line as shown in the image featured right, then continue with corner bead along the vertical straight.

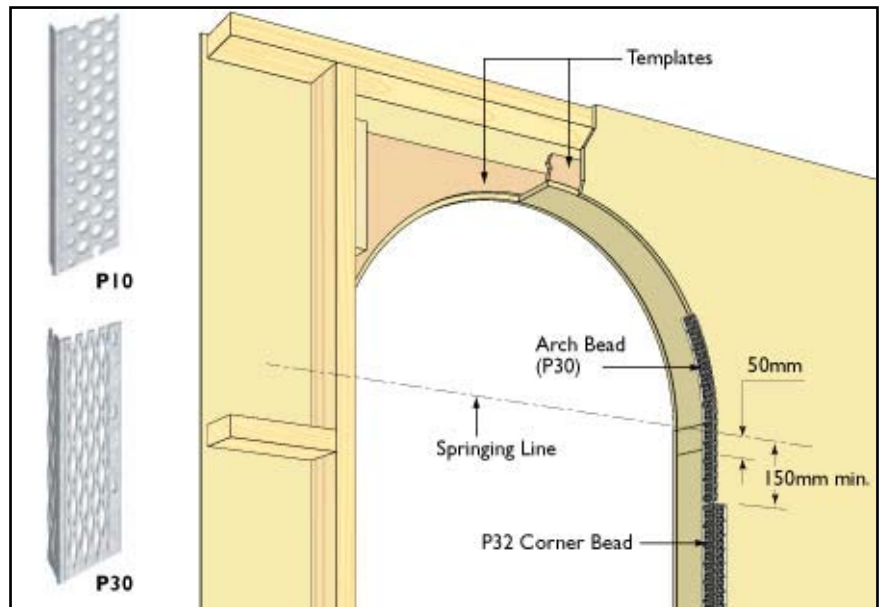

FLASHING ANGLE

The Rondo P40 is a 40x40mm Flashing Angle which, to meet the current Australian Standard requirements, provides a waterproof internal corner when using timber framed junctions in wet areas.

Simply fix the Flashing Angle at a minimum of 1800mm above the floor level to provide a waterproof internal corner.

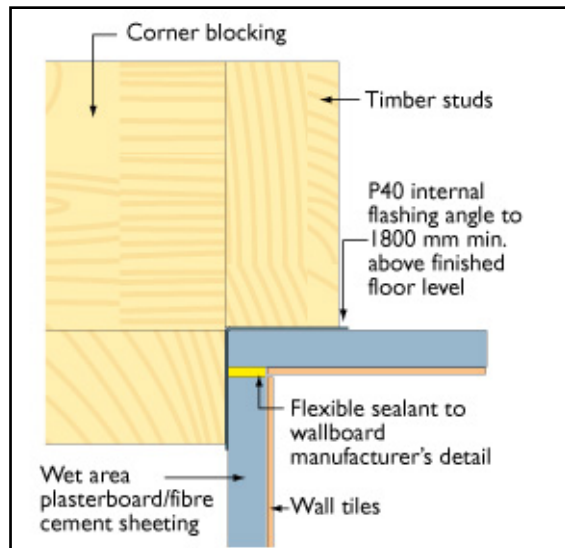

RENDERLOCK CORNER BEADS

R01 & R02 corner beads are suitable for internal render finishes. The R01 has 55mm legs suitable for up to 10mm thick render and a 4.5mm nib. The R02 has 60mm legs suitable for up to 25mm thick render, and a 2.5mm nib which is particularly useful where variations in prestressed concrete and preformed corners require realignment. NOTE: For external applications, use SR03.

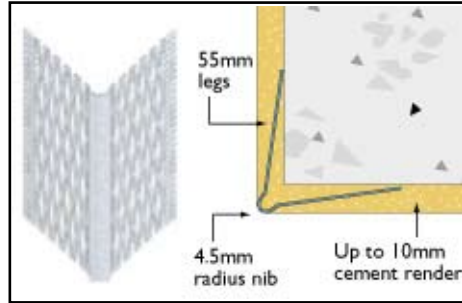

R01 & DETAIL

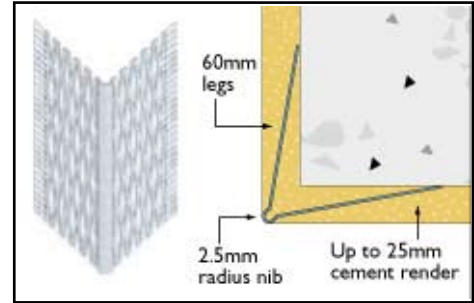

R02 & DETAIL

STOPPING BEADS

The R11 Stopping Bead provides a clean end to 10mm render where it is not bonding into another substrate. The perforated legs ensure the render holds firmly to the bead to prevent any breakaway.

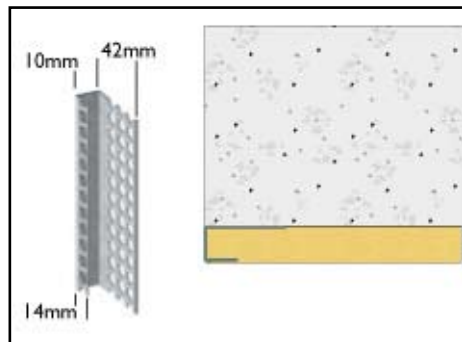

R11 & DETAIL

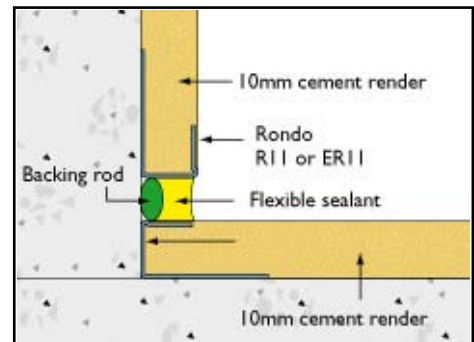

CONTROL JOINT CORNER DETAIL

CONTROL JOINTS FOR RENDER

The R11 can also be used to create Control Joints in render to render situations and render to other substrates. The diagrams featured right show how to achieve the required joint between the varying substrates using the R11 Stopping Bead and flexible caulking compounds.

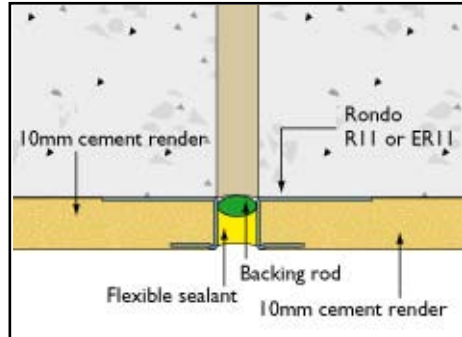

CONTROL JOINT: RENDER

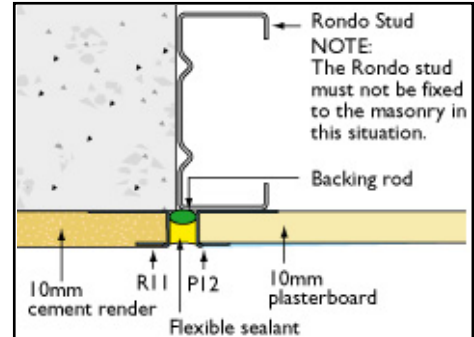

CONTROL JOINT: RENDER/PLASTERBOARD

STOPPING BEAD FOR BLUE BOARD TYPE CLADDING

The EPI7 perforated stopping bead may be used as an edge-capping on 7.5 and 8mm fibre cement board such as Blue Board type products. It also provides a neat starter or finishing strip to the texture coat applied to the board. The EPI7 is suitable for use in exterior applications, however it is recommended to download the Rondo E-Bead warranty or the full EXANGLE® RT brochure for full terms and conditions along with instructions for use.

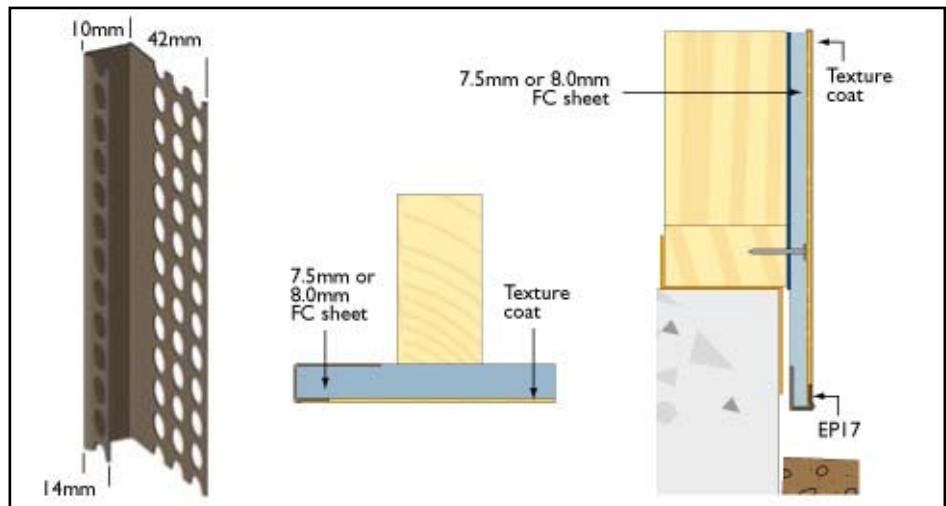

EPI7 & DETAIL

NOTE: This brochure is intended to be used as a guide only; full details should be obtained from the Rondo website, or a Rondo technical CD. Rondo recommends installation by a qualified tradesperson. For all products used externally, visit www.rondo.com.au to download the Rondo EXANGLE® RT manual for correct installation guidelines, or view the E-Bead or SR03 product warranty terms and conditions. For all other advice, speak to your local Authorised Rondo Distributor.

RONDO EXANGLE®

Finishing Sections

GENERAL INFORMATION

The Rondo EXANGLE® and EXANGLE® RT range has been developed over 45 years by Rondo's team of experienced R&D engineers and in close consultation with our customers. Our philosophy of providing our customers with only the best product design ensures that both our interior and exterior range of drywall, render and texture beads are manufactured to assist contractors in obtaining a strong, straight, knock-resistant corner with a superior finish that lasts.

Note that this brochure is intended to be used as a guide only; full details should be obtained from the Rondo website, or a Rondo technical CD available at any Authorised Rondo Distributor outlet. All products in this brochure are for internal use only unless otherwise indicated. Rondo recommends installation by a qualified tradesperson.

See below for just some of the features and benefits you can enjoy when you choose to purchase a genuine Rondo product/system:

FEATURES & BENEFITS

FEATURE	BENEFIT
Code Compliance	The Rondo EXANGLE® range is manufactured from steel that complies to the following standards: AS/NZS 1397:2001 Steel Sheet and Strip, and ASTM B 117 Corrosion Test. The Rondo EXANGLE® RT range also complies with AS3972-1991 Portland Blended Cement, and ASCA 27-1959 Internal Plastering on Solid Backgrounds.
Written Warranty	When installed correctly, Rondo EXANGLE® and EXANGLE® RT products come with a written warranty available at www.rondo.com.au . So you can have peace of mind when using a Rondo product.
Expansive Range	Rondo produce a range of products suitable for internal drywall applications (Rondo EXANGLE®) and interior / exterior render and texture applications (Rondo EXANGLE® RT). This means that the most cost effective application may be used depending on the intended application.
Quality Control	All Rondo products are manufactured using state-of-the-art manufacturing processes by a manufacturer who has been in the business for over 40 years, and are produced under Quality Management System certified to ISO 9001 Standards.

OTHER RONDO BUILDING BOARD AND RENDER PRODUCTS

Below are some additional products not mentioned in this guide. For Full information on these products, refer to the EXANGLE® and EXANGLE® RT Brochures available from the Rondo website: www.rondo.com.au

RONDO EXANGLE® – DRYWALL FINISHING SECTIONS



**P03, P05
P07, P08
Casing Beads**

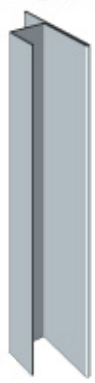

**P06, P09
Shadowline
Casing Bead**



**P18
Timber
Angle**

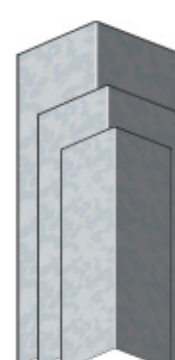

**552, 553, 554
Steel Angles**

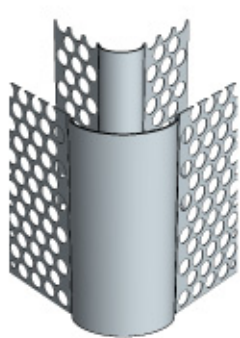

**R05, R06
Bullnose Sections**



**P51/52
Shadow stopping bead**

RONDO EXANGLE® RENDER & TEXTURE FINISHING SECTIONS



**EP32
Expanded Corner Bead**

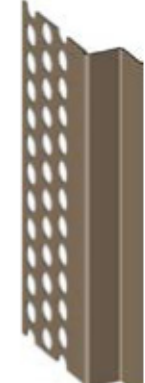

**EP50
Shadowline Bead**



**ER11
Exterior Stopping Bead**



**SR03
Stainless Steel
Render Bead**

Rondo OFFICES

AUSTRALIA

RONDO BUILDING SERVICES PTY LTD

CUSTOMER SERVICE HOTLINE:
1300-36-RONDO (1300-36-7663)

NEW SOUTH WALES

3-33 Glossop Street St Marys NSW 2760
(PO Box 324 St Marys NSW 1790)
Phone: 61-2-9912 7300 Fax: 61-2-9912 7310

VICTORIA

12-14 Dunlop Road Mulgrave VIC 3170
Phone: 61-3-8561 2222 Fax: 61-3-8561 2266

QUEENSLAND

Lot 512 Binary Street Yatala QLD 4207
Phone: 61-7-3287 4944 Fax: 61-7-3287 1881

SOUTH AUSTRALIA

39 George Street Greenfields SA 5107
Phone: 61-8-8283 4065 Fax: 61-8-8283 4320

WESTERN AUSTRALIA

5 Hazelhurst Street Kewdale WA 6105
Phone: 61-8-9353 2944 Fax: 61-8-9353 2955

HEAD OFFICE

PO Box 324 St Marys NSW 1790
Phone: 61-2-9912 7303 Fax: 61-2-9912 7313

EXPORT

Phone: 61-438-427-479 Fax: 61-7-3287-1881

NEW ZEALAND

RONDO BUILDING SERVICES PTY LTD

117A Captain Springs Road Onehunga Auckland
Phone: 64-9-636 5110 Fax: 64-9-636 5111
FREE CALL: 0800-0800-RONDO (0800-0800-76)

MALAYSIA

RONDO METAL PRODUCTS SDN BHD

Lot 606, off Jalan SS 13/1K
Subang Jaya Selangor
Phone: 60-3-5629 2000 Fax: 60-3-5629 2117

INDIA

RONDO METAL SYSTEMS PVT LTD

Level 1, Imperial Heights
Plot No.104, Sher-E-Punjab Society
Andheri-East Mumbai 40093
Phone: 91-988-701-7526

RONDO®

1300-36-RONDO (1300-36-7663) FOR CALLS WITHIN AUSTRALIA
www.rondo.com.au

0800-0800-RONDO (0800-0800-76) FOR CALLS WITHIN NEW ZEALAND
www.rondo.co.nz

